



# SPECIAL OPERATIONS FORCES REFERENCE MANUAL

FOURTH EDITION ★ 2015





# Special Operations Forces Reference Manual

Fourth Edition



The JSOU Press  
MacDill AFB, Florida  
June 2015

Prepared by  
Joint Special Operations University  
and the Center for Special Operations Studies and Research  
MacDill AFB, FL 33621

**The Joint Special Operations University (JSOU).** The Joint Special Operations University (JSOU) provides its publications to contribute toward expanding the body of knowledge about joint special operations. JSOU publications advance the insights and recommendations of national security professionals and the Special Operations Forces (SOF) students and leaders for consideration by the SOF community and defense leadership.

JSOU is the educational component of the United States Special Operations Command (USSOCOM), MacDill Air Force Base, Florida. The JSOU mission is to educate SOF executive, senior, and intermediate leaders and selected other national and international security decision-makers, both military and civilian, through teaching, outreach, and research in the science and art of joint special operations. JSOU provides education to the men and women of SOF and to those who enable the SOF mission in a joint and interagency environment.

JSOU conducts research through its Center for Special Operations Studies and Research (CSOSR) where effort centers upon the USSOCOM mission:

**USSOCOM mission.** Provide fully capable Special Operations Forces to defend the United States and its interests. Synchronize planning of global operations against terrorist networks.

The CSOSR also provides teaching and curriculum support to Professional Military Education institutions—the staff colleges and war colleges. It advances SOF strategic influence by its interaction in academic, interagency, and United States military communities.

The JSOU public Web page is located at <https://jsou.socom.mil>. JSOU publications can also be found on the JSOU library web site at <http://jsou.libguides.com>

Fourth Edition Editorial Team:

John Alvarez

Robert Nalepa

Anna-Marie Wyant

Fred Zimmerman

Book layout and graphic design by

Claire Luke

First Edition, June 2005 (Revised July 2006)

Second Edition, August 2008

Third Edition, September 2011

Fourth Edition, June 2015

This work was cleared for public release; distribution is unlimited.

ISBN 978-1-933749-91-4

**On the Cover.** The cover image depicts special operations forces from U.S. Army Special Operations Command, U.S. Navy Special Operations Command, U.S. Air Force Special Operations Command, and U.S. Marine Corps Forces Special Operations Command conducting activities that are enabled through specialized education, training, and equipment.

The content of this manual represents an ongoing, dynamic project to capture the existing organization, responsibilities, and capabilities of United States Special Operations Command and its subordinate commands. The cutoff date for input to this Fourth Edition was 28 February 2015. Any omissions or errors are completely unintentional.

This reference manual is intended for classroom use and does not necessarily reflect the policy or position of the United States Government, Department of Defense, United States Special Operations Command, or the Joint Special Operations University.



# Contents

<b>Special Operations Forces Reference Manual</b> .....	<b>xi</b>
Preface .....	xi
<b>Chapter 1. Introduction to Special Operations</b> .....	<b>1-1</b>
<b>Special Operations</b> .....	<b>1-1</b>
Four Factors for Successful Special Operations .....	1-1
Characteristics of Special Operations .....	1-1
SOF Truths .....	1-1
SOF Ethic and Culture - Quiet Professionals .....	1-1
<b>Doctrinal Overview of Special Operations Forces</b> .....	<b>1-2</b>
Successful Conduct .....	1-2
United States Special Operations Command .....	1-2
Joint Special Operations .....	1-2
Shaping Environments .....	1-3
The Strategic Environment .....	1-3
<b>Attributes of SOF</b> .....	<b>1-4</b>
Precision Strike and Effects .....	1-4
Tailored and Integrated Operations .....	1-4
Ubiquitous Access .....	1-4
Regional Expertise, Presence, and Influence .....	1-4
C4ISR Dominance .....	1-4
Agile and Unconventional Logistics .....	1-4
Force Protection and Survivability .....	1-4
<b>SOF Operational Framework/SOF Operating Concept</b> .....	<b>1-5</b>
Special Operations and Strategic Challenges .....	1-5
SOF Operating Concept .....	1-5
SOF Core Activities .....	1-6
Stability Operations .....	1-8
Support Considerations for SOF .....	1-8
<b>Chapter 2. Special Operations Force Structure</b> .....	<b>2-1</b>
<b>United States Special Operations Command</b> .....	<b>2-1</b>
USSOCOM—A Unique Organization .....	2-2
Headquarters, U.S. Special Operations Command (HQ USSOCOM) .....	2-3
USSOCOM J2 Intelligence .....	2-4
USSOCOM J3 Operations .....	2-4
Global Mission Support Center (GMSC) .....	2-5
SOF Acquisition, Technology, and Logistics (SOF AT&L) .....	2-5
USSOCOM J5 Strategy, Plans, and Policy .....	2-6
USSOCOM J6 Communications Systems .....	2-6
USSOCOM J8 Force Structure, Requirements, Resources, and Strategic Assessments Directorate .....	2-7
Special Operations Financial Management (SOFM) .....	2-7

USSOCOM Directorate of Force Management and Development (FMD) (J1, J7, J9, and Joint Special Operations University) .....	2-8
Joint Special Operations University (JSOU) .....	2-9
<b>USSOCOM Organizations</b> .....	<b>2-12</b>
Joint Special Operations Command (JSOC) .....	2-12
<b>Theater Special Operations Commands (TSOCs)</b> .....	<b>2-13</b>
Special Operations Command, Africa (SOCAFRICA) .....	2-14
Special Operations Command, Central (SOCCENT) .....	2-15
Special Operations Command, Europe (SOCEUR) .....	2-16
Special Operations Command, Korea (SOCKOR) .....	2-17
Special Operations Command, North (SOCNORTH) .....	2-18
Special Operations Command, Pacific (SOCPAC) .....	2-19
Special Operations Command, South (SOCSOUTH) .....	2-20
<b>SOF Operational Command and Control</b> .....	<b>2-21</b>
Special Operations Forces Joint Task Force .....	2-21
Command and Control of SOF in Theater .....	2-22
Role of the TSOC Commander .....	2-23
Forming a SOF Command and Control Structure (JSOTF or JFSOCC) .....	2-24
SOF as the Lead for a Joint Task Force .....	2-24
Notional Organization of a JSOTF .....	2-25
Joint Special Operations Air Component (JSOAC) .....	2-25
SOF Integration with Conventional Operations and Forces .....	2-26
Joint Military Information Support Task Force (JMISTF) .....	2-27
Joint Civil-Military Operations Task Force (JCMOTF) .....	2-28
NATO Special Operations Component Command-Afghanistan/Special Operations Joint Task Force-Afghanistan (NSOCC-A/SOJTF-A) .....	2-29
<b>Chapter 3. U.S. Army Special Operations Forces</b> .....	<b>3-1</b>
United States Army Special Operations Command (USASOC) .....	3-1
1st Special Forces Command (Airborne) (Provisional) – 1st SFC (A) (P) .....	3-2
Special Forces Regiment .....	3-2
Special Forces Group (Airborne) .....	3-3
Special Forces Group Support Battalion (GSB) .....	3-4
Special Forces Battalion (Airborne) .....	3-6
Battalion Support Company .....	3-6
Special Forces Company .....	3-6
Special Forces Operational Detachment “A” .....	3-7
Army National Guard - Special Operations Detachment (SOD) .....	3-9
Military Information Support Operations (MISO) .....	3-10
95th Civil Affairs Brigade (Airborne) .....	3-14
528th Sustainment Brigade (Special Operations)(Airborne) – SB(SO)(A) .....	3-18
U.S. Army John F. Kennedy Special Warfare Center and School .....	3-21
Task .....	3-21
Organization .....	3-21
75th Ranger Regiment .....	3-24
75th Ranger Regiment Missions .....	3-24
75th Ranger Regiment Organization .....	3-24

U.S. Army Special Operations Aviation Command (USASOAC) .....	3-29
USASOC Flight Company (UFC) .....	3-29
160th Special Operations Aviation Regiment (Airborne) – 160th SOAR(A) .....	3-29
SOAR Mission .....	3-29
SOAR Organization .....	3-29
Responsibilities in Support of SOF CORE Activities .....	3-30
SOAR Aircraft and Employment Considerations .....	3-30
<b>Chapter 4. U.S. Naval Special Operations Forces .....</b>	<b>4-1</b>
Naval Special Warfare Command (NAVSPECWARCOM, also NSWC) .....	4-1
Naval Special Warfare Personnel .....	4-3
<b>NAVSPECWARCOM Organizations .....</b>	<b>4-4</b>
Naval Special Warfare Center (NAVSPECWARCEN/NSWCEN) .....	4-4
Naval Special Warfare Center for SEAL and SWCC .....	4-4
Naval Special Warfare Development Group .....	4-4
Naval Special Warfare Groups .....	4-5
Logistics and Support Units 1, 2, and 3 (LOGSU 1/2/3) .....	4-8
Special Reconnaissance Team 1 and 2 (SPECRECON Team 1/2) .....	4-9
Mobile Communications Teams (MCTs) .....	4-9
SEAL Team .....	4-9
Naval Special Warfare Task Force .....	4-11
Special Boat Teams (SBTs) .....	4-12
SEAL Delivery Vehicle Team .....	4-14
Naval Special Warfare Units .....	4-14
<b>Naval Special Warfare Weapons Systems .....</b>	<b>4-16</b>
Combatant Craft Medium (CCM) .....	4-16
Special Operations Craft–Riverine (SOC-R) .....	4-16
Rigid hull Inflatable Boat (RIB) .....	4-17
Combat Rubber Raiding Craft (CRRC) .....	4-17
SEAL Delivery Vehicle (SDV) MK VIII .....	4-18
Dry Deck Shelter (DDS) .....	4-18
<b>Chapter 5. U.S. Air Force Special Operations Forces .....</b>	<b>5-1</b>
Air Force Special Operations Command (AFSOC) .....	5-1
AFSOC Mission .....	5-1
Air Force Special Operations .....	5-2
AFSOC Employment .....	5-2
<b>Aircraft and Unique Capabilities Summary .....</b>	<b>5-5</b>
AC-130U Spooky .....	5-5
AC-130W Stinger II .....	5-5
MC-130H Combat Talon II .....	5-5
MC-130J Commando II .....	5-5
CV-22 Osprey .....	5-5
EC-130J Commando Solo .....	5-6
C-145A Combat Coyote .....	5-6
C-146A Wolfhound .....	5-6
U-28A .....	5-6
MQ-1B Predator .....	5-6



MQ-9 Reaper	5-6
Special Tactics (ST)	5-6
Combat Aviation Advisors (CAA)	5-7
Augmenting USAF Forces	5-7
<b>AFSOC Active Duty Wings and Groups</b>	<b>5-9</b>
1st Special Operations Wing (1 SOW)	5-9
24th Special Operations Wing (24 SOW)	5-10
27th Special Operations Wing (27 SOW)	5-11
352nd Special Operations Wing (352 SOW)	5-11
353rd Special Operations Group (353 SOG)	5-12
<b>Air Reserve and Air National Guard Components</b>	<b>5-13</b>
919th Special Operations Wing (919 SOW) (AFRC)	5-13
193rd Special Operations Wing (193 SOW) (ANG)	5-13
123rd Special Tactics Squadron, Kentucky Air National Guard	5-13
125th Special Tactics Squadron, Oregon Air National Guard	5-14
150th Special Operations Flight	5-14
107th, 146th, and 181st Weather Flights	5-14
209th Special Operations Civil Engineer Squadron	5-14
280th Combat Communications Squadron	5-14
<b>Air Force Special Operations Forces Logistics</b>	<b>5-15</b>
<b>AFSOC Aircraft and Capabilities</b>	<b>5-16</b>
AC-130U Spooky Gunship	5-16
AC-130W Stinger II	5-16
MC-130H Combat Talon II	5-17
MC-130J Commando II	5-18
CV-22 Osprey	5-19
EC-130J Commando Solo	5-20
C-145A Combat Coyote	5-21
C-146A (Do-328) Wolfhound	5-21
U-28A	5-22
MQ-1B Predator	5-22
MQ-9 Reaper	5-23
Small Unmanned Aviation Systems	5-24
<b>Special Tactics Squadrons (STS)</b>	<b>5-25</b>
Mission	5-25
Specific Employment	5-25
Deployment	5-25
Employment	5-26
Mission Tasks	5-26
Basic Planning Considerations	5-27
<b>Combat Aviation Advisors (CAA)</b>	<b>5-28</b>
Mission	5-28
Operating Rationale	5-28
Concept of Operations	5-29
Employment	5-29
Specialized Training Characteristics	5-30
Organization	5-31

Operating Arenas .....	5-31
Tasking .....	5-32
<b>Air Mobility Command (AMC) C-17 SOLL II .....</b>	<b>5-33</b>
Overview .....	5-33
<b>Air Force Special Operations Air Warfare Center (AFSOAWC) .....</b>	<b>5-34</b>
19th Special Operations Squadron .....	5-34
551st Special Operations Squadron .....	5-34
5th Special Operations Squadron .....	5-34
371st Special Operations Combat Training Squadron .....	5-34
280th Combat Communications Squadron .....	5-35
6th Special Operations Squadron .....	5-35
United States Air Force Special Operations School (USAFSOS) .....	5-35
18th Flight Test Squadron .....	5-35
209th Civil Engineer Squadron .....	5-35
Language Center .....	5-35
<b>Chapter 6. U.S. Marine Corps Special Operations Forces .....</b>	<b>6-1</b>
<b>Marine Corps Forces Special Operations Command (MARSOC) .....</b>	<b>6-1</b>
MARSOC Personnel .....	6-2
MARSOC Command and Control .....	6-4
MARSOC Units .....	6-5
Marine Special Operations School (MSOS) .....	6-10
<b>Appendix A. Special Operations Related Definitions .....</b>	<b>A-1</b>
<b>Appendix B. Abbreviations and Acronyms .....</b>	<b>B-1</b>
<b>Appendix C. Bibliography .....</b>	<b>C-1</b>



# Special Operations Forces Reference Manual

## Preface

This fourth edition of the *Special Operations Forces Reference Manual* was redesigned to support the Joint Special Operations University's academic mission. It provides general information on U.S. Army, Navy, Marine Corps, and Air Force Special Operations Forces (SOF). More specifically, this document is designed to accomplish three broad purposes:

1. Provide a single primary source of reference material on all SOF components
2. Provide an overview of special operations and SOF to facilitate a broader understanding of SOF capabilities to academic institutions and personnel who may not routinely use this data
3. Provide standard SOF reference data to SOF faculty members at professional military education institutions for use in their instruction

The target audience for this manual spans from special operations staff officers and enlisted personnel at United States Special Operations Command

(USSOCOM), its component and subordinate commands, the theater special operations commands, conventional force/unified commands and their staffs that may employ SOF in their areas of responsibility to partner-nation staffs, and both civilian and military educational institutions.

This reference manual is doctrinally based, drawing information and data from joint, USSOCOM, and service publications.

This reference manual is approved for public release; distribution is unlimited. Content for this fourth edition of the SOF Reference Manual was current as of 28 February 2015.

To submit questions, comments, and issues for inclusion in future updates of the manual, or to request a copy of this document, contact:

Joint Special Operations University  
ATTN: CSOSR Editor

7701 Tampa Point Blvd., MacDill AFB, FL 33621

You may also make contact via email at:

[jsou\\_research@socom.mil](mailto:jsou_research@socom.mil).



# Chapter 1. Introduction to Special Operations

## Special Operations

Special operations encompass the use of small units in direct or indirect military actions focused on strategic or operational objectives. These actions require units with combinations of specialized personnel, equipment, and tactics that exceed the routine capabilities of conventional military forces. Special operations are characterized by certain attributes that cumulatively distinguish them from conventional operations. Special operations are often politically sensitive missions where only the best-equipped and most proficient forces must be deployed to avoid detection and possible mission failure.

### *Four Factors for Successful Special Operations*

- a. Clear national and theater strategic objectives
- b. Effective command, control, communications, computers, and intelligence support at the operational level
- c. Competent tactical planning and execution
- d. A force trained, equipped, and organized to conduct special operations

### *Characteristics of Special Operations*

- a. Special operations normally require operator-level planning and detailed intelligence.
- b. Special operations require knowledge of the culture(s) and language(s) of the geographical area in which the mission is to be conducted.
- c. Special operations require rigorous training and mission rehearsals. These are integral to mission success.
- d. Special operations are often conducted at great distances from the supporting operational bases.
- e. Special operations may employ sophisticated communications systems.
- f. Special operations frequently require discriminate and precise use of force. This often requires development, acquisition, and employment of equipment that are not standard for other Department of Defense (DOD) forces.

- g. Special operations employ sophisticated means of insertion, support, and extraction to penetrate and successfully return from hostile, denied, or politically sensitive areas.

### *SOF Truths*

- a. Humans are more important than hardware.
- b. Quality is better than quantity.
- c. Special Operations Forces cannot be mass produced.
- d. Competent Special Operations Forces cannot be created after emergencies occur.
- e. Most special operations require non-SOF support.

### *SOF Ethic and Culture - Quiet Professionals*

The simple, but time-tested, phrase “Quiet Professionals” best describes our SOF ethic and culture - the principles we live by and the behaviors and beliefs we exhibit every day. We are a values-based organization - always mindful that our personal and professional conduct reflects not only on ourselves but on our Nation. We are focused on contributing to the mission at hand and being a well-integrated part of the team—unconcerned with who gets the credit and recognizing that much of what we do will remain in the shadows. We support the Geographic Combatant Commanders (GCCs)—if they are successful, we are successful; if they fail, we fail.



## Doctrinal Overview of Special Operations Forces

Special operations forces (SOF) are small, specially organized units manned by carefully selected people using modified equipment and trained in unconventional applications of tactics against strategic and operational objectives.

### *Successful Conduct*

The successful conduct of special operations relies on individual and small-unit proficiency in specialized skills applied with adaptability, improvisation, and innovation against adversaries often unprepared to react. The unique capabilities of SOF complement those of conventional forces.

### *United States Special Operations Command*

- a. USSOCOM provides trained and combat-ready SOF to geographic combatant commanders and as directed by the President or Secretary of Defense (SecDef); plans and conducts selected special operations worldwide.
- b. USSOCOM is assigned to develop military information support operations (MISO) capabilities in support of the Joint Staff's information operations (IO) responsibilities and provide support to combatant commanders for theater MISO planning and execution.
- c. Commander, USSOCOM is the DOD lead combatant commander for planning, synchronizing, and, as directed, executing global operations against terrorist networks in coordination with other combatant commanders. This role includes:
  - Integrating strategy, campaign plans, intelligence priorities, and operations
  - Theater security cooperation activities are accomplished by GCCs through their Theater Campaign Plans
  - Providing military representation to United States (U.S.) national and international agencies for U.S. and multinational campaigns against terrorist networks
  - Planning and executing regional activities which may support future operations
- d. Commander, USSOCOM exercises combatant command authority (COCOM) of all active and reserve SOF, active U.S. Army MISO, and active civil affairs (CA) forces.

### *Joint Special Operations*

- a. Special operations are conducted in hostile, denied, or politically sensitive environments to achieve military, diplomatic, informational, and/or economic objectives employing military capabilities for which there is no broad conventional force requirement. These operations may require low visibility, clandestine, or covert capabilities. Special operations are applicable across the range of military operations. They can be conducted independently or in conjunction with operations of conventional forces or other government agencies and may include operations by, with, or through indigenous or surrogate forces. Special operations differ from conventional operations in degree of physical and political risk, operational techniques, modes of employment, independence from friendly support, and dependence on detailed operational intelligence and indigenous assets.
- b. SOF perform two types of activities. First, they perform activities that no other forces in DOD conduct. Second, they perform activities that are conducted by DOD forces, but do so to a unique set of conditions and standards.
- c. SOF capabilities include being able to quickly task-organize and deploy using a lower profile or footprint than conventional forces; gaining access to hostile and denied areas; rapidly surveying, assessing, and reporting local situations; working closely with regional military and civilian authorities and populations; organizing people to help solve local problems; and providing tailored or unconventional responses to ambiguous situations. The specialized skills and low-visibility capabilities inherent in SOF provide an adaptable military response in crisis situations requiring tailored, precise, and focused use of force.

- d. SOF limitations stem from their few numbers and the time needed to develop and replace highly trained people and units. Austere SOF logistical support systems require extensive support from conventional force structures. SOF are organized and trained for employment against targets of strategic and operational relevance. SOF are not used as a substitute for conventional forces.

### *Shaping Environments*

In likely or potential areas of operation, SOF play a major role in preparing and shaping environments and, when designated, battlespaces by setting conditions which mitigate risk and facilitate successful follow-on operations. The regional focus, cross-cultural/ethnic insights, and relationships of SOF provide access to and influence in nations where the presence of conventional U.S. forces is unacceptable or inappropriate. SOF contributions provide operational leverage by gathering critical information, undermining a potential adversary's will or capacity to wage war, and enhancing the capabilities of conventional U.S., multinational, indigenous, or surrogate forces.

### *The Strategic Environment*

The strategic environment is characterized by constant evolution and persistent instability. Many aspects of human activity are transitioning—both in scope and rate of change. The following major trends impact SOF and frame their operational challenges in the future:

- a. **Redistribution and Diffusion of Global Power.** The strategic environment will be shaped by power distributed between and within a greater number of states, non-state actors, and individuals. While the traditional roles of the U.S. and Europe will remain, regional powers may take the place of global powers. Megacities may possess the capability to surpass the level of influence previously demonstrated by states.
- b. **Rising Role of Non-State Actors.** Diffusion of power creates instability and uncertainty among populations who questions the legitimacy or effectiveness of those who govern, motivating them to seek alternatives. The accessibility to new technology aids non-state actors and individuals in creating movements and organizing

opposition. Non-state actors also demonstrate the ability and capacity to conduct unconventional warfare, employing a fusion of shared ideologies and interests.

- c. **Easy Access to Advanced Technology.** The expansion of wireless and cyber-infrastructures is empowering populaces and driving rapid social and economic change on an incredibly large scale. Digital and social media allows for unprecedented reach—making the narrative and perception more powerful than ever.
- d. **Shifting Demographics and the Rapid Growth and Expansion of the Urban Environment.** These shifts drive a significant trend toward rapid urbanization that is particularly worrisome in the developing world; where investments in the infrastructure necessary to support these populations have failed to keep pace. The result is feral cities with unplanned urban sprawl, massive slums, and the potential for huge under-governed populations. Peoples' basic needs will go unmet—safety, jobs, health-care, and education.
- e. **Evolving yet Fragile Economic Health of U.S. and Critical Partners.** The strain of national and allied deficits/debts is constraining and reshaping the joint force as well as our allies' and partners' forces. These constraints require a more robust and agile system to prioritize efforts and establish interdependencies with our partners that define SOF in the future while preserving near-term readiness.



## Attributes of SOF

**S**OF are unique because they provide the President and/or the SecDef a broad range of capabilities. The demands of special operations require forces with attributes that distinguish them from conventional forces.

### *Precision Strike and Effects*

SOF perform precision strikes and achieve scalable lethal or nonlethal effects. SOF personnel can survive in a variety of environments, and they can remain on station for extended periods. The persistence of in-area SOF produces effects beyond those of kinetic operations. These effects are achieved through the utilization of human and material assets designed to perform precision reconnaissance and surveillance, and through the employment of a wide variety of weapons and methods, including advanced technologies.

### *Tailored and Integrated Operations*

SOF transform and reshape organizational design and force structure to ensure effective collaboration in joint, interagency, and combined operational environments. SOF elements exercise flexibility at the strategic, operational, and tactical levels, as well as agility in terms of operational time and space considerations, types of missions, and the methods of accomplishment.

### *Ubiquitous Access*

SOF have access to and can potentially influence events or conduct overt or clandestine operations on demand. SOF possess or have access to the latest in emerging and leap-ahead mobility assets to enter, operate in, and be exfiltrated from the designated area of operations.

### *Regional Expertise, Presence, and Influence*

The SOF warrior is also a diplomat, and as such utilizes recurring deployments to hone language skills and cultural awareness, and to build the political and military contacts that contribute to future operations and activities. Forward presence and regional expertise allow for “first response” abilities when required and permit a full range of unconventional military options against a targeted entity.

### *C4ISR Dominance*

Dominance in the realm of command and control, communications, computers, intelligence, surveillance, and reconnaissance (C4ISR) is vital to the success of SOF operations. Exploiting superiority in this area allows the SOF warrior to access, develop, and operate effectively in any situation, taking decisive action that shapes the desired results without effective opposition.

### *Agile and Unconventional Logistics*

SOF are as self-sufficient as possible, but they can be provided with rapid and effective materials, utilizing both service-common and SOF-unique supplies and materials as the situation requires. Superior technology and advanced equipment are used to ensure logistical support is consistently provided to deployed units. The SOF Concept of Logistics Support focuses on providing SOF capability enablers and prepositioned equipment packages to operational elements at the “last tactical mile” with minimal logistics footprint by utilizing support from Service Components and State Department agreements/Host Nation support.

### *Force Protection and Survivability*

SOF elements employ stealth, speed, and countermeasures to ensure survivability and retain freedom of action. To the maximum extent possible, SOF personnel are protected from the effects of enemy offensive systems and can operate under extreme environmental conditions.

# SOF Operational Framework/SOF Operating Concept

## *Special Operations and Strategic Challenges*

SOF provide unique capabilities to address the strategic challenges facing our Nation. SOF's global perspective, understanding of transnational threats and non-state actors, and the ability to operate in concert with U.S. and international partners make SOF ideally suited to address networked adversaries and the transnational nature of aggressor states' influence.

SOF engage with regional partners to include U.S. Government (USG) interagency elements, thereby establishing and strengthening the relationships required to defeat networks. Through first developing then strengthening these relationships, SOF must continue to work through these partnerships to contain regional issues. SOF have the ability to build and leverage existing clandestine networks in hostile and denied areas to coerce and disrupt aggressor states. SOF's capability to operate in remote locations and build capacity provides strategic options to meet the challenges of operating in failed or failing states. For many of these challenges, the primary approach will be special operations campaigns developed and executed by each Theater Special Operations Command (TSOC). These campaigns recognize the protracted nature of these challenges and understand the difficulties in achieving success through episodic instead of reactive operations.

To address the strategic challenges SOF face, a forward-deployed, scalable, and operationally dynamic force positioned using a committed, persistent posture is required. This will enable ongoing engagement with host governments and USG interagency elements to predict and prevent conflict. This posture will present SOF that are:

- a. An intelligence-enabled, networked force able to pursue terrorist threats and their supporting networks to deter, preclude, and preempt actions counter to USG national security interests.
- b. A population-focused, networked force to influence, enable, and integrate friendly nations, partners, and populations.
- c. A force to deter, disrupt, or defeat aggressor states and their surrogates.

## *SOF Operating Concept*

SOF as a strategic option. Regardless of how the future unfolds, SOF will operate effectively to understand, anticipate, influence, respond, and adapt in any foreseeable operating environment.

**The Ends.** A globally networked force of SOF and their strategic partners—joint, interagency, intergovernmental, multinational, nongovernmental, and commercial—is able to prevent conflict and prepared to fight in support of USG efforts to protect and advance U.S. national interests.

- Posture that enables
- Partnerships that endure
- Prevent conflicts
- Prepared to fight

**The Ways.** SOF conduct core activities with a focused, balanced approach through small-footprint distributed operations to understand and influence relevant populations. USSOCOM optimizes and exploits the SOF network to provide strategic options for national leadership in support of USG efforts to enhance stability, prevent conflicts, and when necessary, fight and defeat adversaries. The key elements of this are:

- Understanding the human domain
- Understanding and influencing the narrative
- Enduring engagement through small-footprint distributed operations
- Building sustainable partner capacity and interoperability
- Managing the network
- Building resiliency into the force and families

**The Means.** The operational approaches envisioned in this special operations concept are enabled by force development in the following critical capability areas:

- Sustaining the SOF network
- Cultural and regional expertise
- SOF information environment
- Invisible operator
- Expanded authorities
- SOF enablers
- Advanced technologies

## Special Operations Core Activities

- Direct Action
- Special Reconnaissance
- Counterterrorism
- Unconventional Warfare
- Foreign Internal Defense
- Security Force Assistance
- Hostage Rescue and Recovery
- Counterinsurgency
- Foreign Humanitarian Assistance
- Military Information Support Operations
- Civil Affairs Operations
- Countering Weapons of Mass Destruction

Figure I-1. SOF Core Activities

### *SOF Core Activities*

USSOCOM organizes, trains, and equips SOF for special operations core activities. Additionally, due to inherent capabilities, SOF can also perform collateral activities such as counterdrug operations, support and advise multinational forces (MNFs), personnel recovery (PR) operations, and noncombatant evacuation operations (NEOs).

SOF conduct core activities within the Operational Framework using unique capabilities and under conditions in which other forces are not trained or equipped to operate.

Core activities are operationally significant, unique capabilities SOF apply in different combinations tailored for an operational problem set. Core activities can be applied independently or in combination as part of global, GCC, or joint force commander campaign, operation, or activity. For example, SOF can apply a mix of multiple core activities in both counterinsurgency (COIN) and unconventional warfare operations, but the application of preparation of the environment, special reconnaissance (SR), direct action, and other core activities will vary according to the scope and desired effect of each operation. These core activities reflect the collective capabilities of all joint SOF rather than those of any one service or unit.

#### *Direct Action (DA)*

Short-duration strikes and other small-scale offensive actions conducted as a special operation in hostile, denied, or diplomatically sensitive environments and which employ specialized military capabilities to seize, destroy, capture, exploit, recover, or damage designated targets.

#### *Special Reconnaissance (SR)*

Reconnaissance and surveillance actions conducted as a special operation in hostile, denied, or politically sensitive environments to collect or verify information of strategic or operational significance, employing military capabilities not normally found in conventional forces.

#### *Counterterrorism (CT)*

CT operations include actions taken directly against terrorist networks and indirectly to influence and render global and regional environments inhospitable to terrorist networks. SOF often conduct CT operations through clandestine or low visibility means. SOF activities within CT include, but are not limited to, IO, attacks against terrorist networks and infrastructures, hostage rescue, recovery of sensitive material, and non-kinetic activities to counter ideologies or motivations hospitable to terrorism.

### ***Unconventional Warfare (UW)***

UW enables a resistance movement or insurgency to coerce, disrupt, or overthrow a government or occupying power by operating through or with an underground, auxiliary, and guerrilla force in a denied area. UW can be conducted as part of a GCC's overall theater campaign or as an independent, subordinate campaign. When conducted independently, the primary focus of UW is on political-military objectives and psychological objectives. When UW operations support conventional military operations, the focus shifts to primarily military objectives; however, the political and psychological implications remain. UW includes military and paramilitary aspects of resistance movements and represents the culmination of a successful effort to organize and mobilize the civil populace against a hostile government or occupying power. From the U.S. perspective, the intent is to develop and sustain these supported resistance organizations and to synchronize their activities to further U.S. national security objectives. SOF assess, train, advise and assist indigenous resistance movements to conduct UW and, when required, accompany them into combat.

### ***Foreign Internal Defense (FID)***

FID operations involve participation by civilian and military agencies of a government in any of the action programs taken by another government or other designated organization to free and protect its society from subversion, lawlessness, insurgency, terrorism, and other threats to its security. SOF's primary role is to assess, train, advise, and assist host nation (HN) military and paramilitary forces. The goal is to enable these forces to maintain the HN's internal stability and to address the causes of instability.

### ***Security Force Assistance (SFA)***

SFA involves DOD activities that contribute to unified action by the USG to support the development of the capacity and capability of Foreign Security Forces (FSF) and their supporting institutions. SFA supports the professionalization and the sustainable development of the capacity and capability of FSF, supporting institutions of host countries, and international and regional security organizations. SFA must "directly" increase the capacity and/or capability of FSF and/or their supporting institutions. SFA activities assist host countries



The A/MH-6 is capable of conducting infiltrations, exfiltrations and combat assaults over a wide variety of terrain and environmental conditions.

to defend against internal and transnational threats to stability. However, the DOD may also conduct SFA to assist host countries to defend against external threats; contribute to coalition operations; or organize, train, equip, and advise another country's security forces or supporting institutions. USSOCOM serves as the lead for development of joint SFA doctrine, training, and education.

### ***Hostage Rescue and Recovery***

Hostage rescue and recovery operations are sensitive crisis response missions that include offensive measures taken to prevent, deter, preempt, and respond to terrorist threats and incidents, including recapture of U.S. facilities, installations, and sensitive material.

### ***Counterinsurgency (COIN)***

COIN refers to the comprehensive civilian and military efforts taken to defeat insurgency and to address core grievances. SOF are particularly well-suited for COIN operations because of their regional expertise, language and combat skills, and ability to work among populations and with or through indigenous partners.

### ***Foreign Humanitarian Assistance (FHA)***

Foreign humanitarian assistance is a range of DOD humanitarian activities conducted outside the U.S. and its territories to relieve or reduce human suffering, disease, hunger, or privation. SOF can deploy rapidly with excellent long-range communications equipment, and operate in the austere and often chaotic environments typically associated with disaster-related HA efforts. Perhaps the most important capabilities found within SOF for FHA are their geographic orientation, cultural knowledge, language capabilities, and the

ability to work with multi-ethnic indigenous populations, and international relief organizations to provide initial and ongoing assessments. CA are particularly well suited for stabilization efforts in disaster areas. SOF can provide temporary support, such as airspace control for landing zones, communications nodes, security, and advance force assessments to facilitate the deployment of conventional forces and designated humanitarian assistance organizations until the HN or another organization can provide that support.

### ***Military Information Support Operations (MISO)***

MISO convey selected information and indicators to foreign audiences to influence their emotions, motives, objective reasoning, and ultimately the behavior of foreign governments, organizations, groups, and individuals. The purpose of MISO is to induce or reinforce foreign attitudes and behaviors favorable to the joint force commander's objectives. Dramatic changes in information technology and social networking have added a new, rapidly evolving dimension to operations, and the ability to influence relevant audiences is integral to how SOF address local, regional, and transnational challenges.

### ***Civil Affairs Operations (CAO)***

CAO enhance the relationship between military and civil authorities. CAO require coordination with other governmental agencies, international governmental organizations, nongovernmental organizations, indigenous populations and institutions, and the private sector. CAO include population and resource control, FHA, nation assistance, support to civil administrations, and civil information management. CAO performed in support of special operations are characterized by smaller CA teams or elements, generally without the support of larger military forces, acting in isolated, austere, and, in many cases, politically sensitive environments.

### ***Countering Weapons of Mass Destruction (CWMD)***

CWMD refers to nonproliferation (NP), counterproliferation (CP), and WMD consequence management. WMD are chemical, biological, radiological, or nuclear weapons capable of a high order of destruction or causing mass casualties. CWMD excludes the means of transporting or propelling the weapons where

such means is a separable and divisible part from the weapons. SOF have a role primarily in NP and CP by providing expertise, materiel, and teams to support GCCs to locate, tag, and track WMD; conducting interdiction and other offensive operations in limited areas as required; building partnership capacity for conducting CP activities; conducting MISO to dissuade adversary reliance on WMD; and other specialized technical capabilities. USSOCOM is the lead combatant command for synchronizing planning for operations against terrorist use of WMD and supports U.S. Strategic Command's synchronization responsibility for overall CWMD planning.

### ***Stability Operations***

Stability operations encompass various military missions, tasks, and activities conducted outside the U.S. in coordination with other instruments of national power to maintain or reestablish a safe and secure environment and to provide essential government services, emergency infrastructure reconstruction, and humanitarian relief. Stability operations are aimed at reducing threats from state fragility and instability. Enduring stability operations—consisting of high-quality, low-profile SOF engagement conducted in concert with U.S., inter-agency, international, and HN partners—can mitigate the risk of lengthy post-conflict interventions. Stability operations also include tasks performed after a natural or man-made disaster as part of a humanitarian-based intervention or during major operations and campaigns to establish conditions that enable civilian authorities following cessation of organized hostilities.

### ***Support Considerations for SOF***

#### ***Preparation of the Environment (PE)***

PE is an umbrella term for actions taken by or in support of SOF to develop an environment for current or future operations and activities. SOF conduct PE in support of GCC plans and orders to alter or shape the operational environment to create conditions conducive to the success of a full spectrum of military operations. The regional focus, cross-cultural insights, language capabilities, and relationships of SOF provide access to and influence nations where the presence of conventional U.S. forces is not warranted.

### ***Counter Threat Finance (CTF)***

CTF activities are designed to deny, disrupt, destroy, or defeat the generation, storage, movement, and/or use of assets to fund activities that support an adversary's ability to negatively affect U.S. interests. CTF support can assist SOF in the execution of core activities in many operations, to include, CWMD, CT, UW, FID, SFA, MISO, and CAO.

### ***SOF Combat Support (CS) and Combat Service Support (CSS)***

SOF units generally have limited organic CS and CSS elements, so they normally require additional service-provided CS and CSS to accomplish missions. Due to the high demand, low-density nature of CS, SOF requests these assets through the chain of command or once in theater through the allocation process. With CSS elements, SOF usually deploy with enough CSS to internally support for limited durations of time until theater support structures can be established under the Common User Logistics agreements. Typical service-provided CS and CSS capabilities required to augment or replace SOF CS/CSS organic capabilities are listed below:

#### **Combat Service Support**

- Supply
- Maintenance
- Transportation
- Health service support
- Explosive ordnance disposal
- Field services
- Legal support
- Finance services
- Building and maintaining sustainment bases
- Assessing, repairing, and maintaining infrastructure

#### **Combat Support**

- Indirect fires
- Chemical
- Engineer
- Intelligence
- Information Operations
- Military police
- Signal
- Aviation (reconnaissance, signals intelligence, mobility, strike, and IO)



# Chapter 2. Special Operations Force Structure

## United States Special Operations Command

USSOCOM was formally established as a unified combatant command at MacDill Air Force Base (AFB), Florida, on 16 April 1987.

It is commanded by a four-star flag or general officer with the title Commander, United States Special Operations Command (CDRUSSOCOM).

CDRUSSOCOM exercises COCOM (command authority) for all SOF unless otherwise assigned by the SecDef. USSOCOM

has four service component commands: U.S. Army Special Operations Command (USASOC), Naval Special Warfare Command (NAVSPECWARCOM), Air Force Special Operations Command (AFSOC), Marine Corps Forces Special Operations Command (MARSOC) and eight sub-unified commands: Joint Special Operations Command (JSOC); Special Operations Command, Africa (SOCAFRICA), Special Operations Command, Central (SOCCENT); Special Operations Command, Europe (SOCEUR); Special Operations Command, Korea (SOCKOR); Special Operations Command, North (SOCNORTH); Special Operations Command, Pacific (SOCPAC); and Special Operations Command, South (SOC SOUTH). All but JSOC remain under operational control (OPCON) to the GCCs.

The USSOCOM mission is to provide fully capable and enabled SOF to defend the Nation's interests in an environment characterized by irregular warfare (IW).

USSOCOM responsibilities include:

- Readiness of assigned forces and monitoring the readiness of overseas SOF
- Monitoring the professional development of all SOF personnel



- Developing joint SOF tactics, techniques, and procedures (TTPs)
- Conducting specialized courses of instruction
- Training assigned forces
- Executing its own program and budget (its funding comes directly from Congress and not from the services)
- Conducting research, development, and acquisition of special operations peculiar items
- Synchronizing DOD efforts in the global war against violent extremist organizations
- Developing and managing MISO capability in support of joint force IO

### — SOF Vision —

A Global SOF Network—SOF provides strategic options for our national leaders and the GCCs we support through a Global Network that fully integrates our military, interagency, and international partners.

### — USSOCOM Mission in support of the GCCs—

Defending the Nation and our Citizens -- USSOCOM synchronizes the planning of special operations and provides SOF to support persistent, networked, and distributed GCC operations in order to protect and advance our Nation's interests.

### — SOF Priorities —

- Ensure SOF Readiness
- Help our Nation win
- Continue to build relationships
- Prepare for the future
- Preserve our force and families





USSOCOM was established in the aftermath of the failed 1980 hostage rescue attempt in Iran, but also traces its modern lineage back to the World War II era Office of Strategic Services (OSS). The USSOCOM emblem “the tip of the spear” was also adopted from the OSS emblem.

### *USSOCOM—A Unique Organization*

USSOCOM is a unique organization in that it is a unified combatant command with legislated military department-like authorities. USSOCOM is the “lead” combatant command synchronizing planning for global operations against terrorist networks. When directed by the SecDef, USSOCOM may also conduct special operations missions as a supported command.

In its role as a supporting command, USSOCOM’s primary responsibility is to provide ready SOF to support the geographic combatant commanders. With many of the responsibilities and authorities of a service chief,

CDRUSSOCOM is tasked with ensuring the readiness of SOF.

USSOCOM specific funding addresses requirements that are unique to special operations, with the services being responsible for funding those items that have a broader military usage. Having its own budget is key to USSOCOM’s success, enabling rapid and flexible fielding of equipment that would not otherwise be available.



## Headquarters, U.S. Special Operations Command (HQ USSOCOM)

Over its history, the headquarters has undergone several organizational changes. Important changes took place in 2009 when CDRUSSOCOM directed that HQ USSOCOM be reorganized to align with Joint Staff directorate naming conventions. The reorganization was driven by several factors: recognition of the great value of a USSOCOM three-star officer in the Washington, D.C., area, improving communication within the headquarters and aligning the staff to more closely match supporting and subordinate staff structures. The revised organizational structure reflected primacy of the J-code structure under the Chief of Staff, eliminated the center structures, and positioned the Vice Commander in the National Capital Region to serve USSOCOM interests.

In 2012 the HQ staff had a further reorganization of the J-code staffs. J4, Logistics, was reorganized under the Special Operations Research, Development, and Acquisition Center. The Directorate of Force Management and Development was formed through the merging of the J1, Personnel, J7, Education and Training, and J9, Concept Development staffs into one directorate responsible



United States Special Operations Command Headquarters, MacDill Air Force Base, Florida

for talent management, development, education, and training of SOF.

USSOCOM HQ staff supports the nation’s most elite warriors and delivers the finest capability, in the least time and at the best cost to the U.S. taxpayers. USSOCOM staff considers itself the most innovative, responsive and dedicated staff in the world. Its priority is SOF narrative and their families. The staff’s motto is “Demand the Best!”

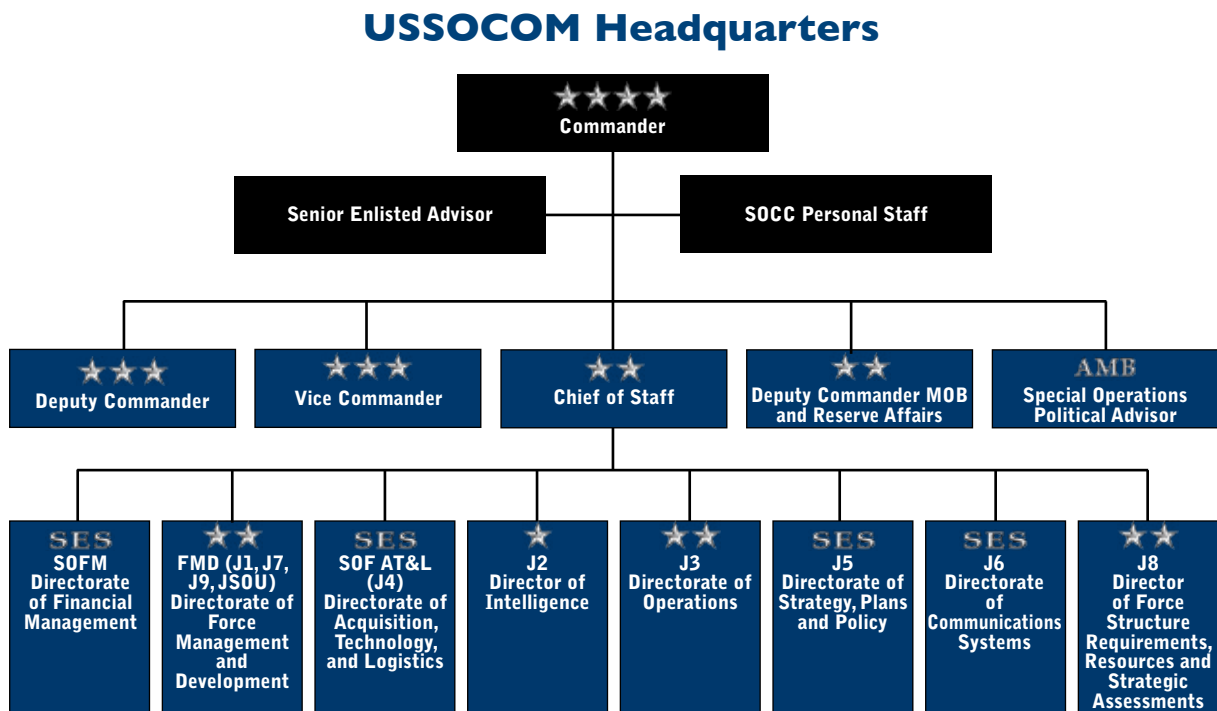

Figure 2-I. Headquarters, U.S. Special Operations Command

### USSOCOM J2 Intelligence

**Mission.** To create and maintain a superb intelligence team that networks externally to the Intelligence Community and internally within SOF to drive USSOCOM global war against violent extremist organizations

campaign planning, Intelligence Community and Interagency collaboration, and to provide a professional SOF interagency force.

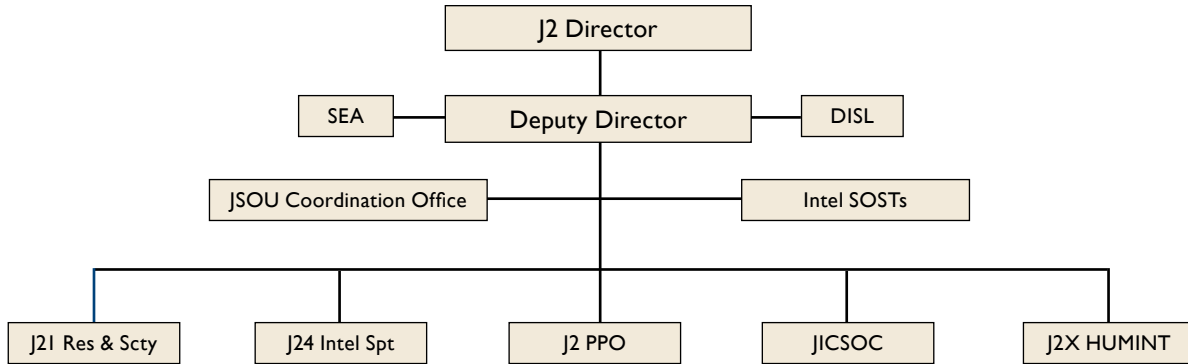

Figure 2-2. J2 Organization

### USSOCOM J3 Operations

**Mission.** Conduct worldwide global force management of SOF, direct and support select special activities, lead DOD efforts in military information support planning and coordination, and provide global situational

awareness and connectivity for USSOCOM leadership. Synchronize, and when directed, conduct special operations.

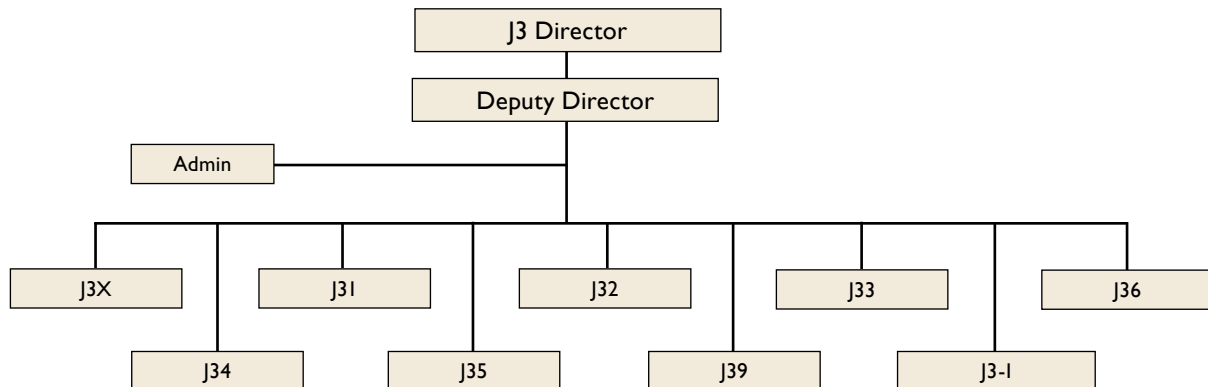

Figure 2-3. J3 Organization

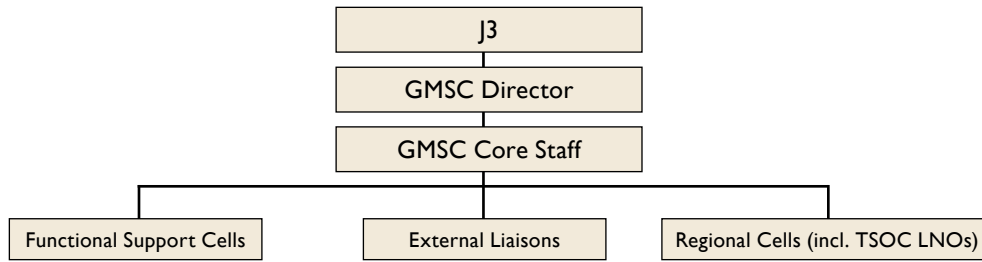

Figure 2-4. GMSC Organization

### Global Mission Support Center (GMSC)

**Mission.** As the proponent for the USSOCOM engagement synchronization process the GMSC is tasked to develop and integrate timely, accurate global awareness to support the SOF network in day-to-day operations and crisis response; enable responsive support to the SOF network; and, manage the SOF network strategic battle rhythm.

The GMSC is responsible for the following primary functions:

#### Manage the Strategic Engagement Process

- Manage the strategic engagement portal
- Link enterprise engagements to a grand strategy
- Analyze and advise on messaging, engagements, and provide recommendations to optimize strategic engagements.

#### Enhance global awareness of the SOF network

- Illuminate and make sense of trends and opportunities in support of the SOF Campaign Plan (CP-SOF)
- Track SOF worldwide presence and demand
- Integrate information on operations, plans, and threats

- Keep senior leaders informed of critical events and crises

#### Provide responsive support to TSOCs, Service Components, and Partner Nations

- Coordinate expedited resolution to requests for information, forces, or support
- Provide easy 24/7 access into HQ USSOCOM
- Enable GCCs, TSOCs, and Service Components in meeting their mission requirements

#### Manage the strategic battle rhythm

- Coordinate key battle rhythm events to promote unity of effort across the SOF network
- Reinforce the USSOCOM commander’s intent and direction to the enterprise
- Integrate crisis response actions into overall operations
- Provide a focal point for coordination and collaboration with Combatant Commands

### SOF Acquisition, Technology, and Logistics (SOF AT&L)

**Mission.** Provide rapid and focused acquisition, technology, and logistics to SOF.

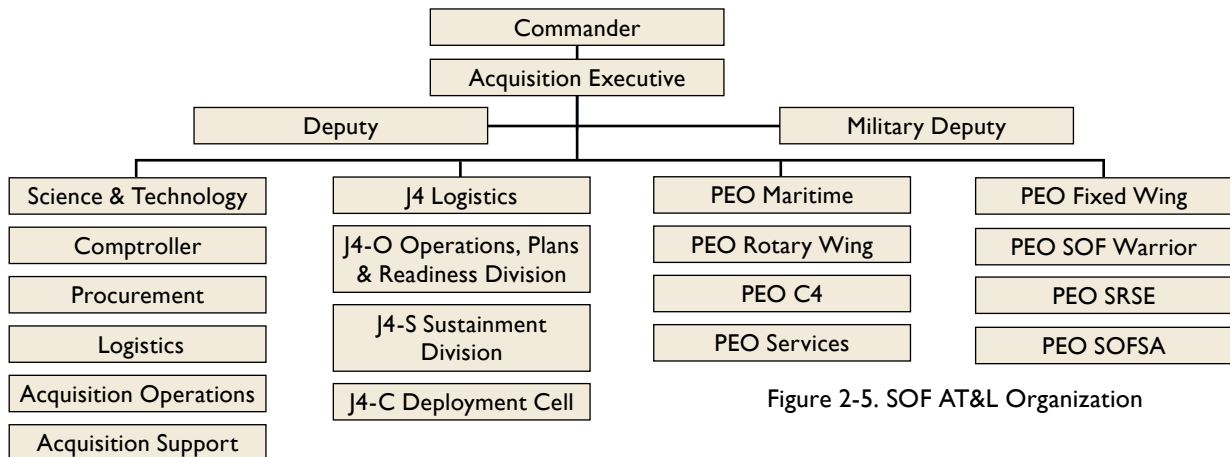

Figure 2-5. SOF AT&L Organization

### USSOCOM J5 Strategy, Plans, and Policy

**Mission.** In support of national strategic guidance and DOD policy, develop USSOCOM strategy, policy, and plans to posture and employ SOF worldwide, and to

synchronize the global war against violent extremist organizations to achieve strategic end states as defined in global and theater campaign plans.

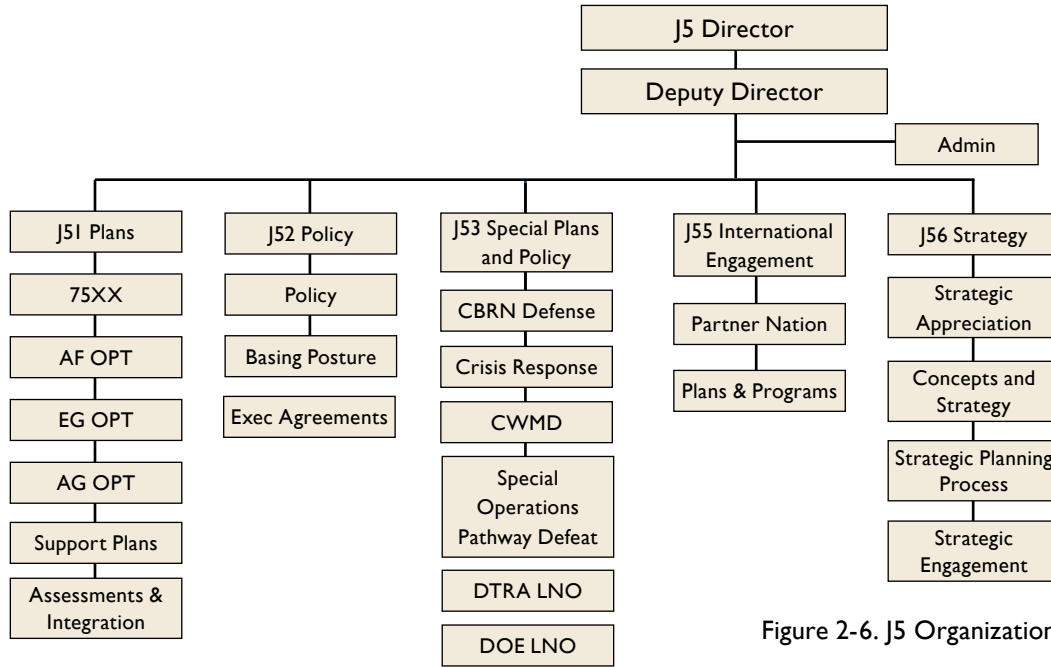

Figure 2-6. J5 Organization

### USSOCOM J6 Communications Systems

**Mission.** The Directorate of Communications Systems installs, operates, maintains, and defends the global/expeditionary SOF information environment in order to provide standards based, interoperable, redundant command, control, communications, computers,

intelligence, surveillance, and reconnaissance services to garrison and deployed SOF as an enabling capability to planning and execution of pre-crisis activities and ongoing global operations.

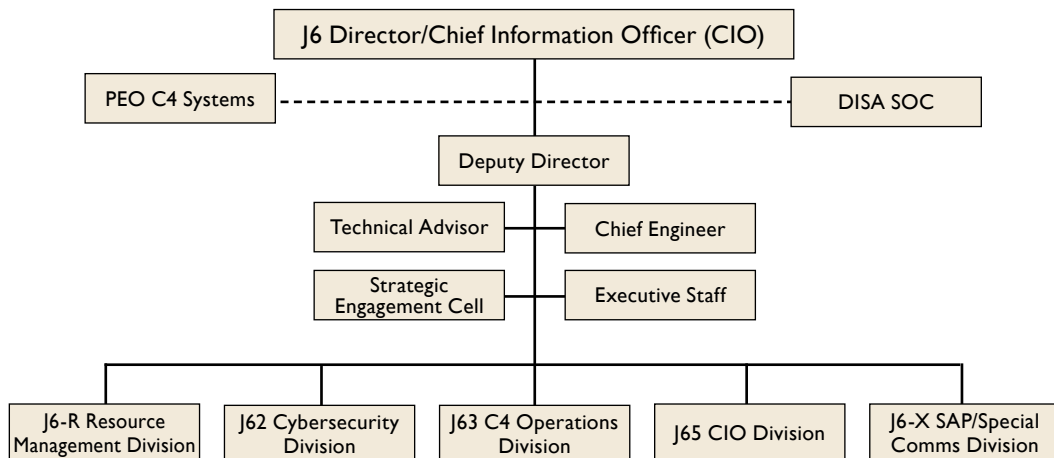

Figure 2-7. J6 Organization

**USSOCOM J8 Force Structure, Requirements, Resources, and Strategic Assessments Directorate**

**Mission.** The Force Structure, Requirements, Resources, and Strategic Assessments Directorate provides the CDRUSSOCOM a program of resourced requirements for the sustainment of current and future SOF mission capabilities designed to meet the needs of USSOCOM

customers. The directorate’s responsibilities include conducting analysis and strategic assessments, managing the USSOCOM requirements process, and developing an out-year resource forecast.

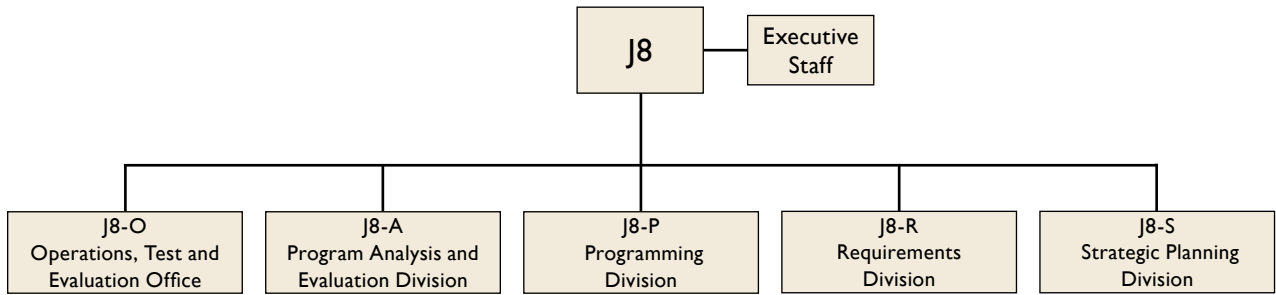

Figure 2-8. J8 Organization

**Special Operations Financial Management (SOFM)**

**Mission.** Advise the CDRUSSOCOM, the USSOCOM staff, the component commanders, and TSOCs on all financial management matters. Prepare, submit, and defend all budget products, and analyze the execution

of the command’s funding and Congressional appropriation matters. Utilize a strategy-to-resource integration approach across the planning, programming, budget, and execution process.

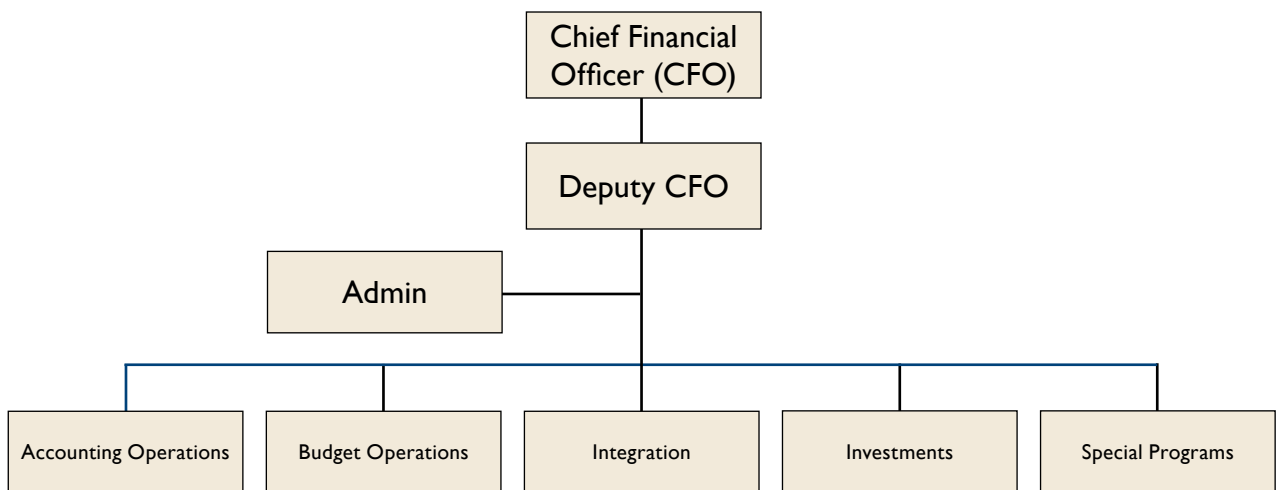

Figure 2-9. SOFM Organization

**USSOCOM Directorate of Force Management and Development (FMD)(J1, J7, J9, and Joint Special Operations University)**

**Mission.** Promote the advancement and value of our people and their families from recruitment through retirement in order to build a resilient, adaptive, well-trained and professionally educated Special Operations Force.

**Lines of Effort**

**Our People**

- Training
- Education
- Experience
- Family

**Our Force**

- Collective training
- Exercises and wargames
- Readiness
- Leader development

**Special Operations Proponent**

- Develop doctrine (how we fight today)
- Develop concepts (how we will fight tomorrow)
- Experimentation and war-gaming
- Provide the intellectual foundation for all special operations

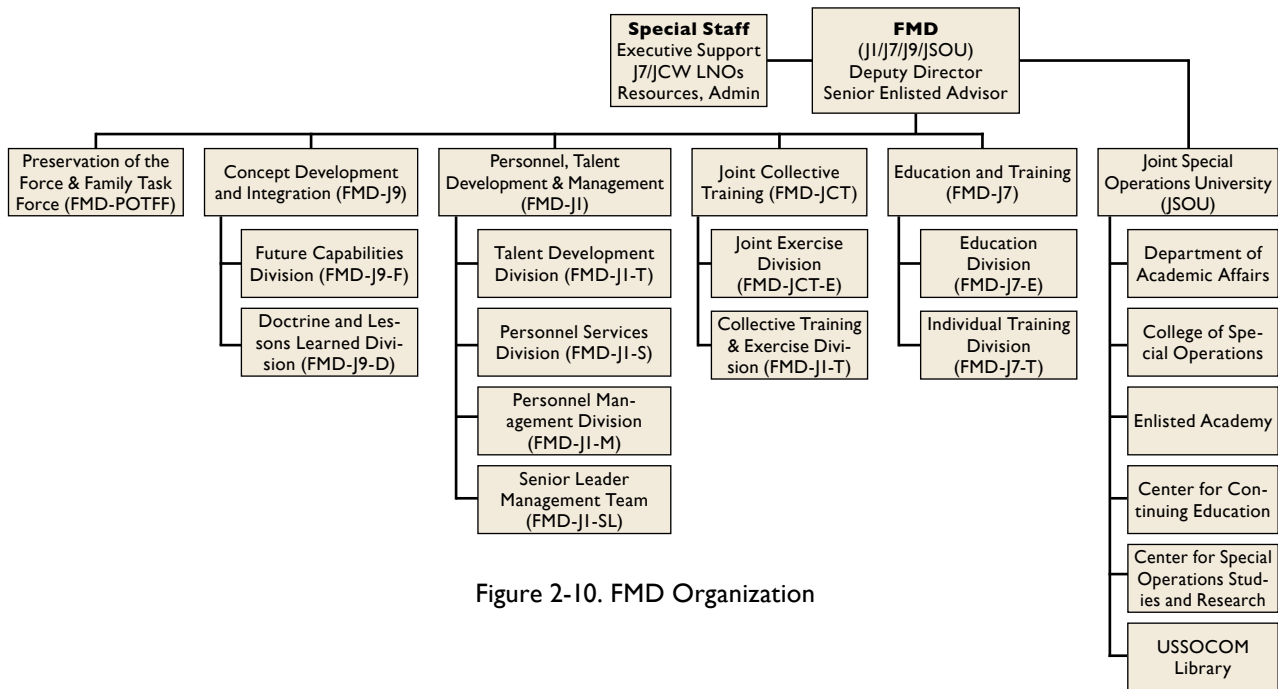

Figure 2-10. FMD Organization

## Joint Special Operations University (JSOU)

The Joint Special Operations University (JSOU) is a professional military education (PME) institution that serves as USSOCOM's Academic Center of Excellence for Special Operations Studies and Research. JSOU is designed to create, provide and sustain postsecondary-level knowledge through teaching, research and outreach in the strategic and operational art of joint special operations. The university is organized to facilitate the Title 10 United States Code responsibilities of the CDRUSSOCOM to prepare SOF to carry out assigned missions and to increase the combat readiness of the force by conducting specialized courses of instruction. JSOU is a production-oriented educational activity of the USSOCOM and collocated at MacDill AFB.



JSOU is firmly based on four foundational elements that reinforce the SOF truth that humans are more important than hardware:

- a. **Advanced Education.** JSOU will expand opportunities for degree, fellowship, and certificate programs and will accomplish this both in-house and through partnerships with civilian and military colleges. JSOU will achieve degree-granting authority to facilitate completion of bachelor's and master's degrees.
- b. **Professional Military Education.** JSOU will maximize the learning experience for SOF in PME, enhance SOF knowledge in the conventional, and promote SOF electives, core curriculum, and academic exercises.
- c. **International Programs.** JSOU will enhance the SOF network through education, fostering academic relationships with SOF partners and allies, and collaboration with international PME institutions.
- d. **Lifelong Learning.** JSOU will promote continuous educational opportunities throughout SOF operators' careers utilizing diversified delivery

methods, continue to provide short course format designed for just-in-time learning, focus on operational & strategic level joint knowledge, while maximizing college credit through articulation agreements.

**Vision.** A globally recognized academic institution that serves the entire Department of Defense as the Center of Excellence for Special Operations knowledge and research. JSOU is the foundation of joint professional development throughout the special operations community, investing in the entire SOF team of officers, non-commissioned officers (NCOs), warrant officers and civilians. This is achieved by maintaining the high standards of an accredited academic institution, delivering relevant special operations focused curricula where needed, retaining a highly competent faculty proficient in multiple teaching methods and by rapidly adapting to a changing global environment.

**Mission.** To prepare SOF to shape the future strategic environment by providing specialized joint PME, developing SOF specific undergraduate and graduate level academic programs and by fostering special operations research, analysis and outreach in support of USSOCOM objectives.

**History.** In September 2000, JSOU was activated as an institution of higher learning focused on joint special operations education. General Peter Schoomaker, former CDRUSSOCOM, envisioned JSOU to support specific educational requirements for SOF and non-SOF national security decision-makers. In 2008, JSOU became the educational component of USSOCOM. JSOU's mission remains to provide joint SOF education. JSOU's goal is the professional preparation of all SOF personnel to lead integrated forces effectively in peace and in war. JSOU delivers this education to the military, interagency, and international communities using a variety of methods ranging from traditional resident courses to innovative applications of technology. Originally established at Hurlburt Field, with an initial cadre of 20 personnel, the university relocated to MacDill AFB (Pinewood Facility) in October 2010, and has reached a steady-state faculty and staff level of approximately 165. JSOU now owns, for the first time, its own classrooms and is positioned to both use the skills and expertise of HQ USSOCOM while



providing tailored academic programs that directly support its mission. Departments are capable of delivering post-secondary through graduate-level level curricula. In 2012, JSOU was incorporated into the USSOCOM HQ staff under the Force Management Directorate. Construction is nearly complete on a brand new JSOU facility on MacDill AFB located very near the existing USSOCOM complex with a projected move to the new facility from the Pinewood Facility in early 2016.

**Organization.** JSOU's activities are specialized and associated with the USSOCOM mission to train and prepare the joint SOF. The JSOU president, a member of the Senior Executive Service, reports to the CDRUS-SOCOM through the director, Force Management and Development (FMD). JSOU organizational structure includes an executive vice president (military deputy); a command senior enlisted leader; and an academic vice president for academic affairs, whose responsibilities include academic standards, accreditation, curriculum and faculty development, admissions/registrar, academic counseling, education technology, and distance learning. JSOU is organized around its five educational pillars.

- a. Department of Academic Affairs
- b. College of Special Operations
- c. Enlisted Academy
- d. Center for Continuing Education
- e. Center for Special Operations Studies and Research

**Department of Academic Affairs.** Academic Affairs is the primary source of student services, curriculum and faculty development, and institutional standards for JSOU. It prepares and sets academic rigor using evaluation and assessment along with education technology tools. The department is also responsible for ensuring JSOU meets relevant standards of accreditation. The department's mission is to maintain the highest standards for curriculum and instruction to ensure quality courses are conducted while providing top rated student, faculty, and course support services.

**College of Special Operations.** The College of Special Operations is responsible for developing accredited graduate certificate and accredited undergraduate courses. The college is also responsible for the USSOCOM

Research Library, which serves JSOU, students, HQ USSOCOM staff, and the component commands. Lastly, the college is responsible for supporting special operations-related content in officer PME in both service and joint intermediate and senior colleges.

**Enlisted Academy.** The Joint Special Operations University Enlisted Academy (JSOU-EA) designs, develops and implements joint SOF enlisted PME courses for USSOCOM's enlisted force. JSOU-EA's mission is "to educate joint special operations forces enlisted leaders across a professional academic continuum, providing the knowledge to think critically and lead successfully in current and future operating environments." JSOU-EA achieves this mission by providing four levels of enlisted professional military education courses within the Career Education Program (CEP)—the Joint Fundamentals Course (CEP-1), the Enterprise Management Course (CEP-2), the Joint Special Operations Forces Senior Enlisted Academy (CEP-3) and the Summit Course (CEP-4).



- a. Joint Fundamentals Course. The Joint Fundamentals Course (CEP-1) develops the E-6 enlisted special operator and enablers for leadership careers in special operations.
- b. Enterprise Management Course. The Enterprise Management Course (CEP-2) develops the E-7 enlisted special operator and select enablers for leadership careers in special operations.
- c. Joint Special Operations Forces Senior Enlisted Academy. The Joint Special Operations Forces Senior Enlisted Academy (JSOFSEA, CEP-3) brings together select E-8 and E-9 special operators and enablers from all four U.S. military special operations service components, international and interagency partners to create a one-of-a-kind enlisted education environment. This course creates "Warrior Diplomats." The student gains valuable education in mission-oriented leadership fields of study, providing the

student with the knowledge to think critically and lead successfully in the Joint, Interagency, Intergovernmental and Multinational (JIIM) environment.

- d. Summit Course. The Summit Course (CEP-4) is designed to prepare the O-6 command level Senior Enlisted Leader (SEL) for service at a nominative level SEL position. The Summit Course focuses on applying cognitive competencies in strategic thinking to analyzing and developing national policies and strategies to resolve problems at the local, regional, and global levels.

**Center for Continuing Education.** The Center for Continuing Education focuses on specialized courses of study that address non-credit curricula, staff and functional courses, international courses through mobile education teams, and TSOC and component support. The core elements of this pillar are:

- a. Educational support to SOF Chairs and SOF faculty at PME institutions
- b. Professional development and tailored SOF education at USSOCOM HQ, component HQs, and TSOCs
- c. SOF educational integration support to the NATO School
- d. Joint Military Education Teams

**Center for Special Operations Studies and Research (CSOSR).** CSOSR, established in 2013, is a SOF intellectual center that serves USSOCOM and the SOF enterprise. CSOSR is a SOF-focused organization that conducts directed research and analysis in national security, military strategy, and global and regional studies. CSOSR publishes its research through the JSOU Press, its in-house publishing capability. As CSOSR matures, it will provide expanded research capability through credentialed faculty, academic outreach to the SOF enterprise, selected think tanks, and academia. CSOSR is also positioned for a future capability that will facilitate publication of a quarterly, peer reviewed, SOF professional journal.

## USSOCOM Organizations

USSOCOM is a unified command of active duty and reserve personnel. Active duty SOF elements assigned to USSOCOM are organized into four service component commands and eight sub-unified commands. Army SOF (Chapter 3) are structured under the U.S. Army Special Operations Command; Navy SOF (Chapter 4) are organized under the Naval Special Warfare Command; Air Force SOF (Chapter 5) are grouped under the Air Force Special Operations Command; and the Marine Corps SOF (Chapter 6) are formed under the Marine Corps Forces Special Operations Command.

### *Joint Special Operations Command (JSOC)*

JSOC was established in 1980 and is located at Fort Bragg, North Carolina. JSOC is a joint headquarters designed to study special operations requirements and techniques, ensure interoperability and equipment standardization, plan and conduct joint special operations exercises and training, and develop joint special operations tactics.



Figure 2-II. Headquarters USSOCOM and Special Operations Subordinate Command Locations

## Theater Special Operations Commands (TSOCs)

Since 1988, each of the theater unified commands has established a separate Special Operations Command (SOC) to meet its theater-unique special operations requirements. As of 2013, all SOF based OCONUS, to include the TSOCs, are under combatant command (COCOM) of CDRUSSOCOM and OPCON of their respective GCCs. As the commander of a subunified command, TSOC commander is a joint force commander (JFC) with the authority to plan and conduct joint operations as directed by the GCC and to exercise OPCON of assigned and attached forces. The TSOC Commander may designate subordinate joint special operations task force (JSOTF) commanders and establish Joint Task Forces (JTF) to plan and execute operations. The TSOC Commander may also function as a Joint Forces Special Operations Component Commander (JFSOCC) within a GCC-established joint force.

TSOCs provide the planning, preparation, and command and control of SOF from the Army, Navy, Air Force, and Marine Corps. They ensure SOF strategic capabilities are fully employed and SOF are fully synchronized with conventional military operations, when applicable.

TSOCs offer several advantages to the geographic combatant commanders. As peacetime elements, the TSOCs are the nuclei around which JSOTFs can be structured. TSOCs also provide a clear chain of command for

in-theater SOF as well as the staff expertise to plan, conduct, and support joint special operations in the theater's area of responsibility (AOR). These special operations may include forces under OPCON to a TSOC. TSOCs normally exercise OPCON of SOF within each geographic combatant commander's AOR. Additionally, the TSOCs ensure that SOF personnel fully participate in theater mission planning and that theater component commanders are thoroughly familiar with SOF operational and support requirements and capabilities.

There are seven TSOCs that support six geographic combatant commanders and U.S. Forces Korea. They are as follows:

- a. Special Operations Command, Africa
- b. Special Operations Command, Central
- c. Special Operations Command, Europe
- d. Special Operations Command, Korea
- e. Special Operations Command, North
- f. Special Operations Command, Pacific
- g. Special Operations Command, South

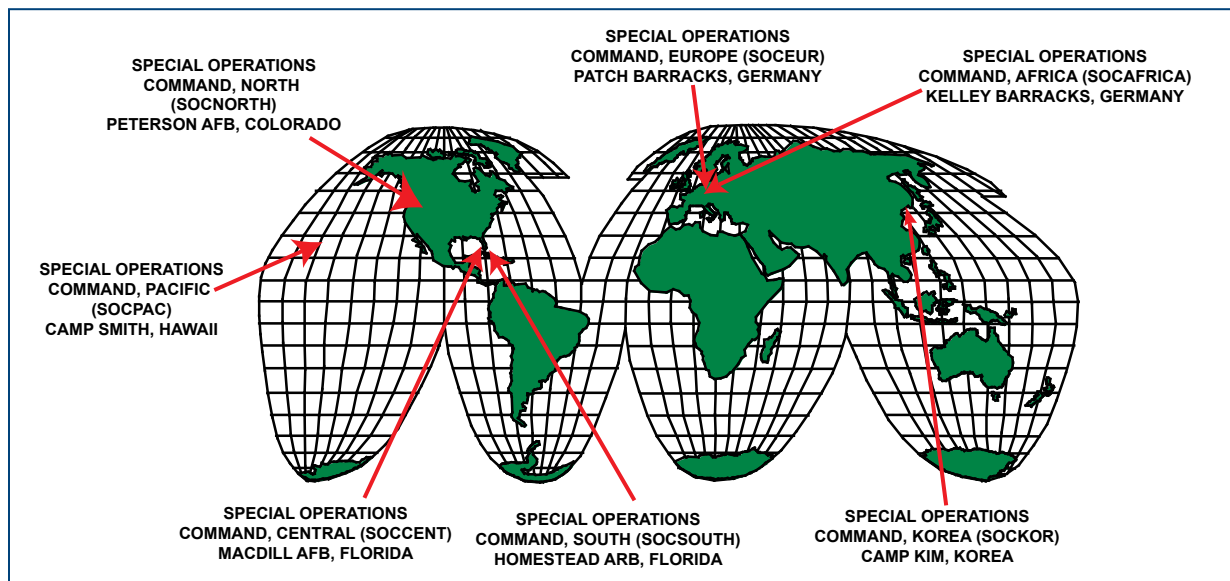

Figure 2-12. Worldwide Special Operations Command Locations

## Special Operations Command, Africa (SOCAFRICA)

SOCAFRICA was established 1 October 2007 and became fully operational in April 2009.

SOCAFRICA is under COCOM of CDRUSSO-COM and OPCON to U.S. Africa Command (USAFRICOM), and is currently headquartered at Kelley Barracks, Germany. The commander of SOCAFRICA (COMSOCAFRICA) is a brigadier general and functions as the director of the Africa Command Special Operations Directorate.



**Mission.** SOCAFRICA leads, plans, coordinates, and as directed, executes the full spectrum of special operations by, with, through, or in support of U.S. government departments and agencies, partner nations and other organizations as part of an integrated theater strategy, in order to promote regional stability, combat terrorism, and advance U.S. strategic objectives in the USAFRICOM AOR.

**Operational Approach.** SOCAFRICA's force alignment provides an operational approach that directs the placement of tailored, high-impact teams in strategic locations to conduct SOF objectives, activities, and actions. By achieving persistent access, placement, and influence with strategically positioned Special Operations Commands Forward (SOCFWDs), SOCAFRICA will be effectively postured to address the most urgent problems in a flexible manner. SOCAFRICA's operational approach will employ the unique attributes of SOF to attain mission objectives and synchronize all SOF operations, exercises, and security cooperation activities in the USAFRICOM AOR to achieve our strategic end states. Resources will include, but are not limited to, named operations, training exercises, equipment programs, key leader engagements, and military-to-military cooperation events. We will also facilitate and support Department of State led security assistance programs and other inter-agency endeavors.

**Organization.** SOCAFRICA is organized into a command group, special staff, staff directorate, and component commanders.

The command group consists of the commander, senior enlisted leader, deputy commander, chief of staff, foreign policy advisor, executive officer and Secretary, Joint Staff (SJS).

The special staff includes the surgeon, reserve affairs officer, public affairs officer and the staff judge advocate (SJA).

Staff directorate includes Headquarters Commandant; J1 Human Resources; J2 Intelligence; J3 Operations; J4 Logistics; J5 Strategy, Plans, and Programs; J6 Communications; and J8 Resource Management.

Component commanders include SOCFWD West Africa, SOCFWD East Africa, SOCFWD Central Africa, and JSOAC.

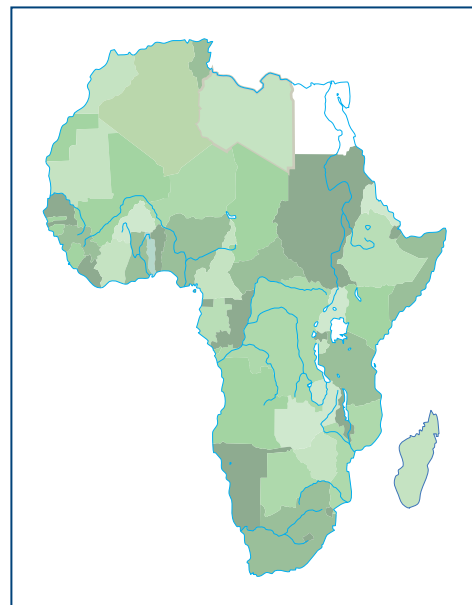

Figure 2-13. SOCAFRICA

## *Special Operations Command, Central (SOCCENT)*

SOCCENT, headquartered at MacDill AFB, is under COCOM of CDRUSSOCOM and OPCON to U.S. Central Command (USCENTCOM). It also has a forward headquarters, the Combined Forces Special Operations Component Command (CFSOCC), in Qatar. SOCCENT is responsible for planning special operations throughout the USCENTCOM AOR; planning and conducting peacetime joint/combined special operations training exercises; and orchestrating command and control of peacetime and wartime special operations as directed. SOCCENT exercises OPCON of assigned and attached SOF, which deploy for training and for operational missions in the USCENTCOM AOR as directed by Commander, CENTCOM (CDRUSCENTCOM). When directed by CDRUSCENTCOM, SOCCENT forms the nucleus of a JSOTF.

SOCCENT is organized and aligned along traditional joint operational lines with a command group, six numbered/functional directorates (J1, J2, J3, J4, J5, J6 and J8) and a headquarters command section.

Specific SOCCENT mission tasks include:

- a. Assist and advise CDRUSCENTCOM on all matters pertaining to special operations in the USCENTCOM AOR
- b. Develop partner nation counterterrorism and counterinsurgency capacity
- c. Conduct Joint Chiefs of Staff (JCS)-directed exercises
- d. Plan and conduct humanitarian assistance and civic actions with countries receptive to U.S. military presence
- e. Plan, conduct, and evaluate other joint exercises, mobile training teams (MTTs), deployments for training (DFT), and joint combined exchange training (JCET) in support of theater, regional, and country strategies

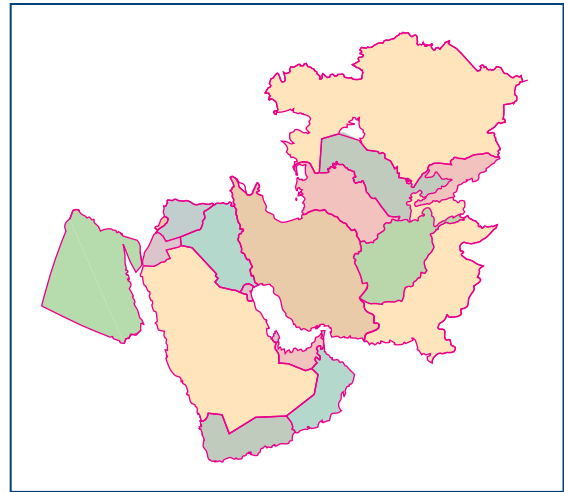

Figure 2-14. SOCCENT

## Special Operations Command, Europe (SOCEUR)

SOCEUR is under COCOM of CDRUSSOCOM and OPCON to U.S. European Command (USEUCOM), headquartered at Patch Barracks, Stuttgart, Germany. SOCEUR's primary responsibility is to exercise operational control over forward-based or attached Army, Navy, Air Force, or Marine Corps SOF conducting operational missions or training in the USEUCOM AOR.



Commander, SOCEUR (COMSOCEUR), is one of five commanders (along with U.S. Army, Europe; U.S. Air Forces in Europe; Naval Forces, Europe; and Marine Corps Forces, Europe) in the USEUCOM AOR who may be designated to establish or lead a European JTF to plan, coordinate, and conduct military operations in support of USEUCOM or the Supreme Allied Commander Europe (SACEUR). During selected wartime and contingency operations, COMSOCEUR is routinely tasked by Commander, USEUCOM (CDRUSEUCOM) to establish a JSOTF and deploy to forward locations to provide command, control, communications, and intelligence for assigned U.S. and allied SOF as required.

SOCEUR is organized as a conventional joint staff with a command group and seven J-coded functional directorates. SOCEUR exercises control of one Army Special Forces Battalion, one Air Force Special Operations Group with two subordinate Air Force Special Operations Flying Squadrons and one Air Force Special Tactics Squadron, one Naval Special Warfare Unit, and a Signal Support Detachment. SOCEUR also maintains proponentcy for CA and MISO.

### Key Tasks

- a. Advise CDRUSEUCOM on special operations mission priorities, force structure and apportionment, command and control, joint and bilateral training, readiness requirements, and employment of forces.
- b. Develop supporting plans and annexes for USEUCOM operations plans, contingency plans, and

functional CDRUSEUCOM-directed operational tasks.

- c. Exercise OPCON and ensure readiness of all forward-based and allocated SOF in theater. Conduct USEUCOM- or JCS-directed exercises to ensure readiness.
- d. Plan and conduct EUCOM-directed HN-US training, development, and professional military-to-military contacts (MTT, JCET, DFT, JCTP, etc.) with European armed forces.
- e. Coordinate with USEUCOM service component commanders and SOF service component commanders to maximize economy in the utilization of U.S. special operations resources and eliminate unnecessary duplication and nonessential activities.
- f. Establish and maintain close coordination and dialogue with service components, subordinate USEUCOM commands, Allied Command Europe, USSOCOM, and the NATO Special Operations Headquarters (NSHQ).

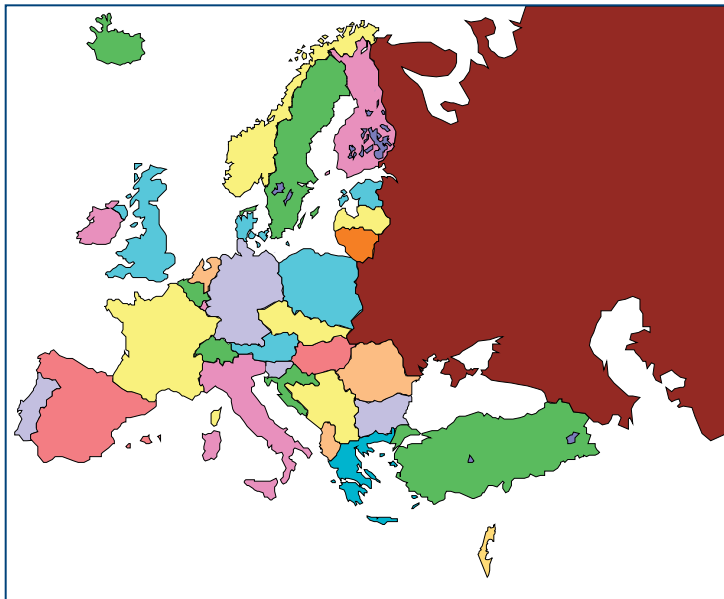

Figure 2-15. SOCEUR

## Special Operations Command, Korea (SOCKOR)

Operating under armistice at Camp Kim, Korea, SOCKOR is under COCOM of CDRUSSOCOM and OPCON to USPACOM and further delegated to U.S. Forces Korea (USFK). SOCKOR is responsible for planning, coordinating, and conducting joint and combined special operations in the commander, USFK area of operations (AO) in support of the commander, United Nations Command/Republic of Korea (ROK)-United States Combined Forces Command.



In armistice, SOCKOR is established as a traditional joint headquarters with a command group and six directorates augmented by the 112 Signal Battalion (Special Operations) (Airborne), Detachment-Korea and an Air Liaison Element (ALE). It exercises OPCON of the Special Forces Detachment 39 and tactical control (TACON) of other U.S. SOF units training in Korea. SOCKOR helps build ROK capacity via three lines of operation:

- a. Conducting joint and combined training, using the JCET program and JCS exercises
- b. Developing ROK capabilities, using a SOF Doctrinal Conference and CA and MISO JCETs with the ROK Ministry of National Defense
- c. Operating Special Forces (SF) Detachment 39, which sends a liaison officer to each ROK SF brigade and group and enhances US/ROK interoperability by training, advising, and assisting

Focused primarily on deterrence and preparation for warfighting, SOCKOR is the only theater SOC in which U.S. and allied SOF are institutionally organized for combined special operations. If hostilities resume in Korea, elements of SOCKOR and the ROK Army Special Warfare Command, Republic of Korea Naval Special Warfare Brigade, and the Republic of Korea Air Force Special Operations Squadron will establish the Combined Forces Command Combined Unconventional Warfare Task Force (CUWTF). CUWTF is commanded by a ROK lieutenant general, with the SOCKOR commander as his deputy.



Figure 2-16. SOCKOR



## Special Operations Command, North (SOCNORTH)

On 5 November 2013, Special Operations Command North (SOCNORTH) was formally activated as a Sub-Unified Command to USSOCOM, with OPCON transferred at that time to Commander USNORTHCOM. SOCNORTH is currently at initial operating capacity, located at Peterson AFB, Colorado.



SOCNORTH provides Commander USNORTHCOM with a dedicated SOF C2 structure, matching that of other Global Combatant Commanders and consistent with the Defense Strategic Guidance calling for low-cost, limited footprint approaches to national security objectives.

The USNORTHCOM AOR includes air, land, and sea approaches and encompasses the continental United States, Alaska, Canada, Mexico, and the surrounding water out to approximately 500 nautical miles. It also includes the Gulf of Mexico, the Straits of Florida, and portions of the Caribbean region, to include The Bahamas, Puerto Rico, U.S. Virgin Islands, British Virgin Islands, and the Turks and Caicos Islands.

**Mission.** SOCNORTH, under commander USNORTHCOM guidance, supports its homeland defense, civil support, and security cooperation missions to defend and secure the United States and its interests. The commander of USNORTHCOM is responsible for theater security cooperation with Canada, Mexico, and The

Bahamas. SOCNORTH has aligned mission requirements throughout the USNORTHCOM AOR, both foreign and domestic. SOCNORTH operations within the United States are in support of the appropriate lead federal agencies and in accordance with all applicable laws and policies.

SOCNORTH has also been designated by CDRUSNORTHCOM as the supported command for DOD counter-terrorism related activities, and specialized support of federal law enforcement with the USNORTHCOM AOR.

SOCNORTH is currently commanded by a two-star Flag Officer with an Army, Navy, Air Force, Marine Corps, and civilian staff with special operations expertise. Interagency partners have shown interest in assigning LNOs directly to SOCNORTH. Canadian SOF are assigned to SOCNORTH as non-reciprocal exchange officers, including the Vice-Commander.

SOCNORTH enables USNORTHCOM, as an integrated part of the SOF network capable of collaborating with interagency and international partners, to counter or defeat terrorists and other emerging transnational threats.



Figure 2-17. SOCNORTH

## Special Operations Command, Pacific (SOCPAC)

SOCPAC is under COCOM of CDRUSSOCOM and OPCON to U.S. Pacific Command (USPACOM), headquartered at Camp Smith, Hawaii.

As USPACOM's TSOC, SOCPAC coordinates, plans, and directs special operations and related activities in the Pacific Theater.

This supports Commander, USPACOM objectives of deterring aggression, advancing regional security cooperation, responding to crises, and fighting to win. Since the terrorist attacks of 9/11, SOCPAC has been fully engaged with the Armed Forces of the Philippines. For over a decade, the Joint Special Operations Task Force-Philippines (JSOTF-P) advised and assisted the Armed Forces of the Philippines in counterterrorism activities. SOCPAC will continue to engage with the Armed Forces of the Philippines to increase its capability to support civil authority and human rights, and enhance its capability to defeat terrorist and insurgent threats.

The Commander, SOCPAC is the advisor for special operations on the USPACOM staff. The staff is organized with a command group, seven directorates (SOJ1-SOJ7), and is augmented by the Joint Intelligence Support Element (JISE/JICPAC) and a detachment from the 112th Signal Battalion.

Part of SOCPAC's capability is based around JTF 510. The JTF is a composite of SOCPAC service members task organized as a rapidly deployable headquarters. JTF 510 provides the USPACOM Commander with the ability to quickly establish command and control in support of emerging crises, such as disaster relief for tsunamis or earthquakes, humanitarian assistance for civil strife or noncombatant evacuation operations (NEO), or threat situations involving terrorist incidents.



SOCPAC is assigned OPCON of one Army Special Forces Battalion, one Naval Special Warfare Unit, and one Air Force Special Operations Group, which includes two Air Force Special Operations Squadrons and one Air Force Special Tactics Squadron. Additionally, SOCPAC maintains a Joint Special Operations Air Component (JSOAC) in Hawaii and a forward-based Joint Special Operations Air Detachment.

SOCPAC's strategy rests on a synchronized concept of operations called the indirect approach. The indirect approach focuses on three lines of operation: increasing partner nation security capacity, improving information gathering and sharing, and securing the support of the population. Specific tools used by SOCPAC in support of these lines of operations include the following:

- a. Joint combined exchange training (JCET)
- b. Counternarcotics training (CNT)
- c. Foreign internal defense (FID)
- d. Subject matter expert exchange
- e. Humanitarian assistance/disaster relief
- f. Humanitarian civic action programs
- g. Humanitarian mine action (HMA)
- h. Information operations and public affairs
- i. Pacific Area Special Operations Conference
- j. Joint Chiefs of Staff/USPACOM exercises

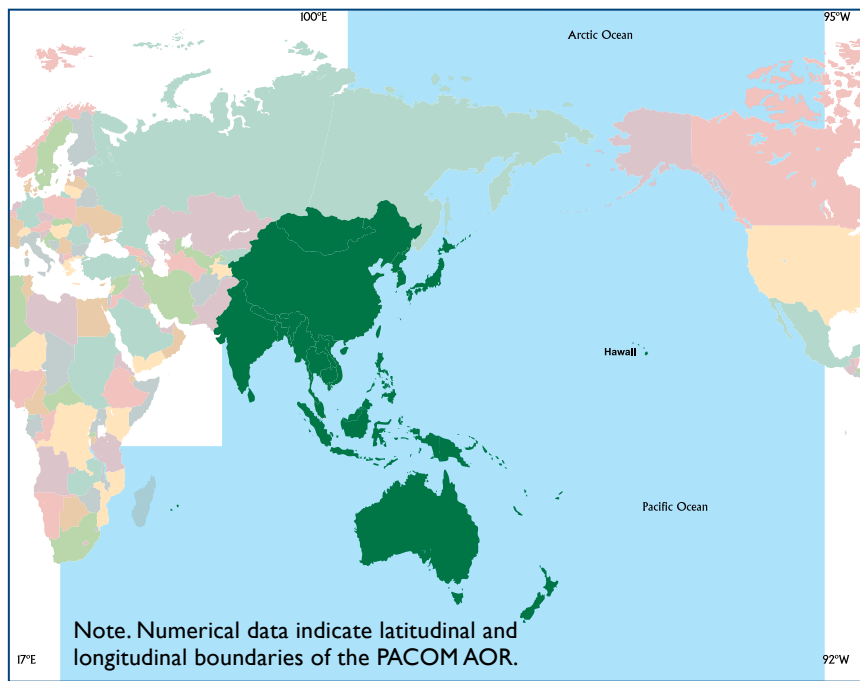

Figure 2-18. SOCPAC

## Special Operations Command, South (SOCSOUTH)

SOCSOUTH is under COCOM of CDRUSSOCOM. CDRUSSOUTHCOM normally exercises OPCON of USSOF through CDRSOUTH. CDRSOUTH exercises OPCON of subordinate forces directly from the TSOC location at Homestead Air Reserve Base, Florida, or through smaller elements positioned at key locations (normally within the AOR) known as Special Operations Command Forward.

SOCSOUTH forms and deploys a JSOTF headquarters, when directed, to provide C4I during contingencies and emergencies. Assigned forces include one Army Special Forces Company, one Army Special Operations Aviation Company, and one Naval Special Warfare Unit.

SOCSOUTH is organized as a sub-unified command with a command group and seven functional directorates, J1 through J6 and J8.

**Mission.** SOCSOUTH plans, directs, and executes special operations missions throughout Central America, South America, and the Caribbean to achieve operational and strategic objectives in support of CDRUSSOUTHCOM.



SOCSOUTH core tasks include the following:

- a. SOUTHCOM situational awareness team
- b. Crisis response force
- c. JSOTF HQ
- d. Understand the environment and threats
- e. Build focused PN capacities that lead to operational results
- f. Enhance networking with all partners
- g. Deter/disrupt VEOs

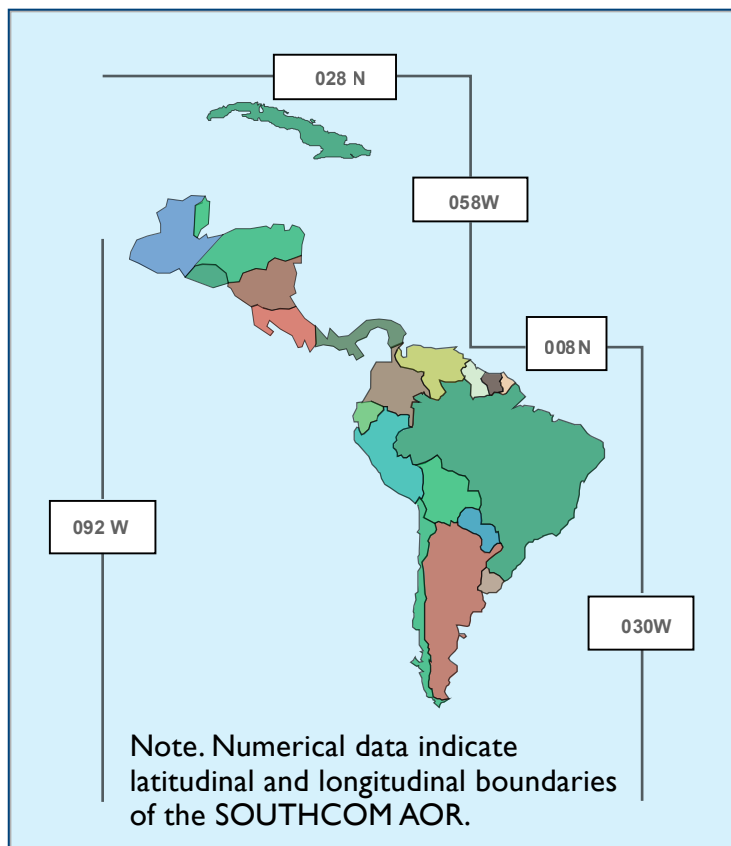

Figure 2-19. SOCSOUTH

## SOF Operational Command and Control

Command is the most important function undertaken by a JFC because it is the exercise of authority and direction by a properly designated commander over assigned and attached forces. Command and control (C2) is the means by which a JFC synchronizes and/or integrates joint force activities to achieve unity of command and ties together all the operational functions and activities. C2 applies to all levels of war and echelons of command across the range of military operations. TSOC commanders, JSOTF commanders, and the Joint Force Special Operations Component Commander (JFSOCC), when designated, are all JFCs.

C2 of SOF normally should be executed within a SOF chain of command. The identification of a C2 organizational structure for SOF should depend upon specific objectives, security requirements, and the operational environment. The guiding principle is to place all SOF in an operational area or tasked with a specific mission or operation under a single SOF commander with the authority to coordinate special operations among all supporting and supported units. In all cases, commanders exercising command authority over SOF should:

- a. Provide for a clear and unambiguous chain of command.
- b. Avoid frequent transfer of SOF between commanders.
- c. Provide for sufficient staff experience and expertise to plan, conduct, and support the operations.
- d. Integrate SOF early in the planning process.
- e. Match unit capabilities with mission requirements.

SOF are most effective when special operations are fully integrated into the overall plan. The ability of SOF to operate unilaterally, independently as part of the overall plan, or in support of a conventional commander requires a robust C2 structure for integration and coordination of the SOF effort. Successful special operations require centralized, responsive, and unambiguous C2 through an appropriate SOF C2 element. The limited window of opportunity and sensitive nature of many SOF missions require a C2 structure that is,

above all, responsive to the needs of the operational unit and provides the most flexibility and agility in the application of SOF. SOF C2 may be tailored for a specific mission or operation. Liaison among all components of the joint force and SOF, however they are organized, is vital for effective SOF employment, as well as coordination, deconfliction, synchronization, and the prevention of fratricide.

### *Special Operations Forces Joint Task Force*

For military engagement, security cooperation, and deterrence operations, forward-based and distributed C2 nodes under the OPCON of the CDRTSOC provide the necessary C2 for assigned and attached SOF. The special operations joint task force (SOJTF) is the principal joint SOF organization tasked to meet all special operations requirements in major operations, campaigns, or a contingency.

- a. SOJTF. A SOJTF is a modular, tailorable, and scalable SOF organization that allows USSOCOM to more efficiently provide integrated, fully capable, and enabled joint SOF to GCCs and subordinate JFCs based on the strategic, operational, and tactical context. SOF capacity may be especially challenged during major combat operations or other large-scale campaigns. When theater SOF requirements exceed the TSOC's capacity, GCCs may request an SOJTF from USSOCOM. In coordination with the GCC, theater component, and JTF commanders, the SOJTF commander is responsible for planning, integrating, and conducting of special operations in a designated operational area. When tasked, the SOJTF commander may plan, integrate, and conduct all military operations in the designated theater of operations.
- b. A SOJTF is composed of four elements: the HQ, SOF units, support forces, and service-provided capabilities. The HQ element provides the C2 of all SOF in the SOJTF. It may augment existing capability, or provide the full theater capability, as required. The second element is the SOF

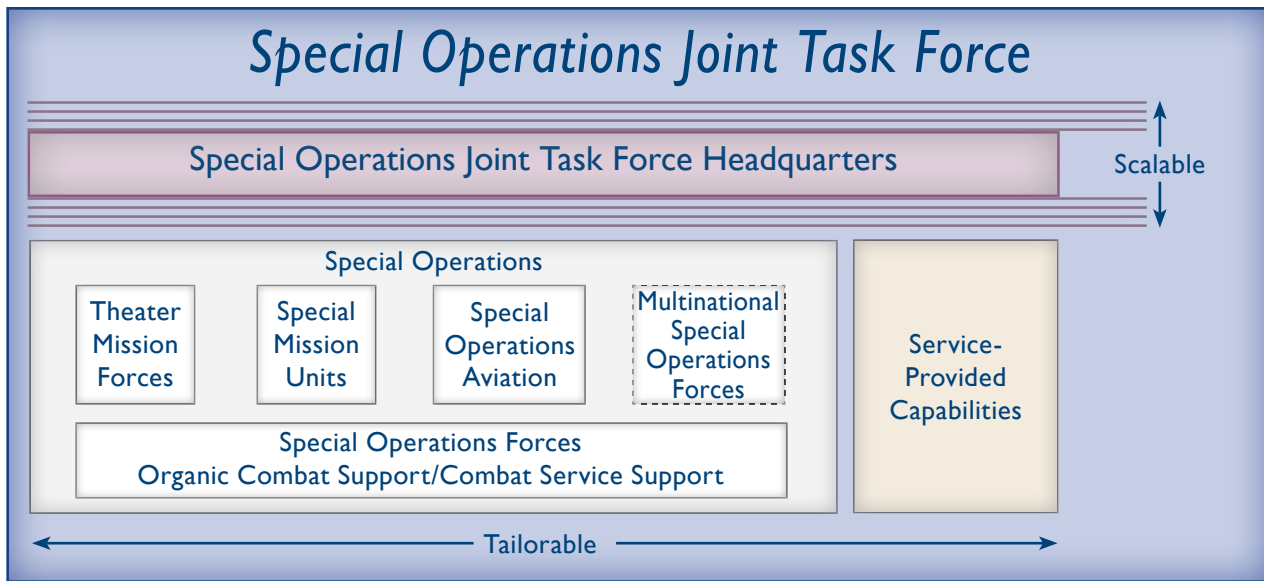

Figure 2-20. Special Operations Joint Task Force

units, which may include air, ground, maritime, and special designated SOF capabilities. The third element includes the SOF organic combat support and combat service support capabilities, which may include, but are not limited to, aviation support, fires support, intelligence, logistics, and communications. Since SOF are limited in size and capability, the fourth element consists of service-provided capabilities augmented from conventional forces. The SOJTF scalability also allows expanding into a MNF as required (see Figure III-1).

- c. Depending on circumstances, the SOJTF may be directed to serve as the JTF or a JFSOCC. The SOJTF provides a capability to C2 multiple JSOTFs and a joint special operations air component (JSOAC) or a JTF consisting of both CF and SOF.

### *Command and Control of SOF in Theater*

All SOF are assigned to USSOCOM and are under the COCOM of CDRUSSOCOM. However, SOF assigned to a GCC are under the OPCON of that GCC.

When SOF are transferred to a GCC from USSOCOM or from another GCC, and the transfer of forces

A TSOC is a subordinate unified command of USSOCOM and is the primary theater SOF organization capable of performing broad, continuous missions uniquely suited to SOF capabilities and is the organization through which a GCC exercises C2 over attached SOF. While USSOCOM exercises COCOM of all SOF to include the TSOCs, USSOCOM delegates assigned OPCON of the TSOCs to their respective geographical combatant commander. The TSOCs are sub-unified commands in support of their respective GCCs.

is permanent or for an anticipated long period of time, the forces are reassigned to the gaining GCC. When the transfer of forces is temporary or for an anticipated short period of time, the forces may be either reassigned or attached.

When forces are transferred, it is important to specify command relationships. This is normally done in a deployment order. Normally, if the forces are reassigned, the gaining GCC exercises COCOM of the reassigned force. If the forces are attached, the command relationship could be OPCON, TACON, or support, depending on the operational requirements. A GCC normally

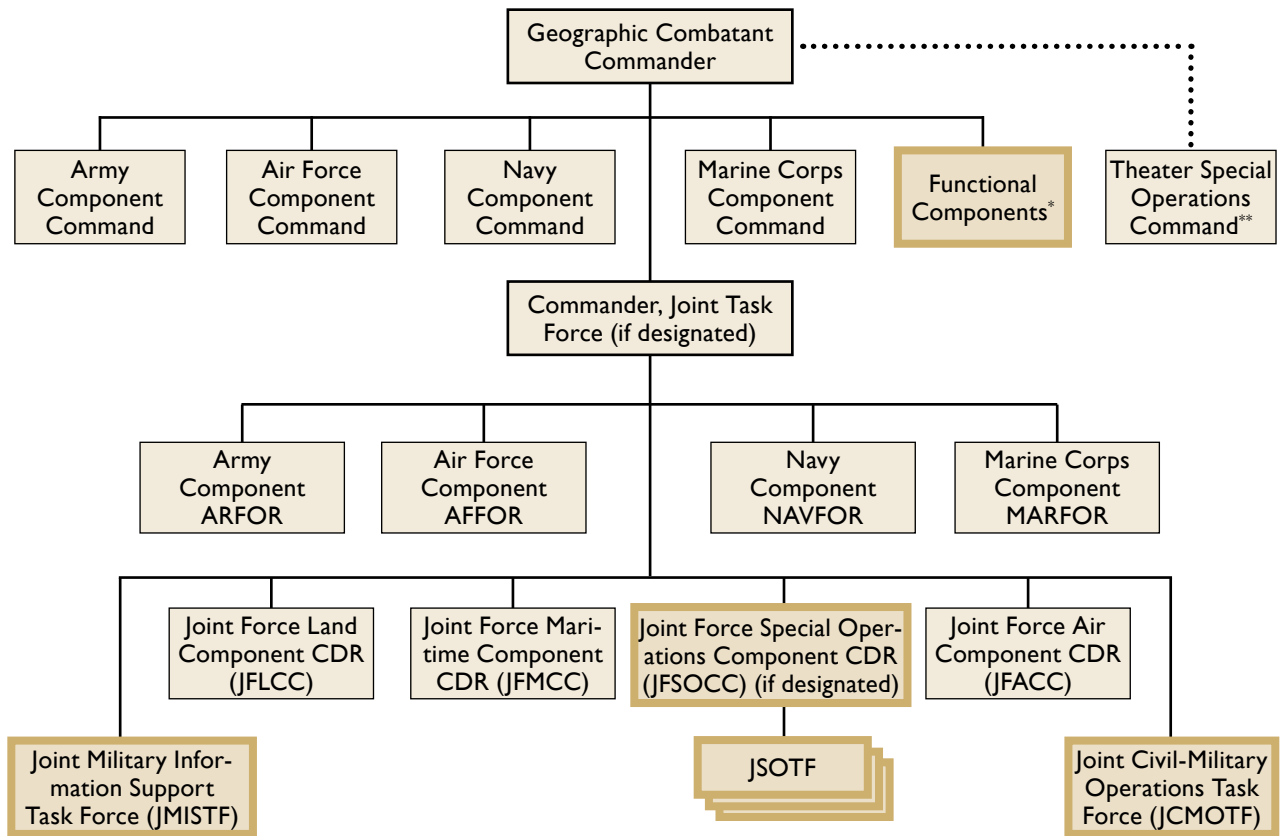

\* Functional component commanders report to the establishing JFC (GCC or CJTF)  
 \*\* CDRTSOC may also function as a JFSOCC and/or a CDR of a JSOTF, JMISTF, and/or a JCMOTF

Figure 2-21. Notional Command and Control of Special Operations Forces

exercises OPCON of all assigned SOF, as well as command and control of all attached SOF, through the TSOC commander, or a subordinate JFC (see figure 2-23). That C2 relationship over attached forces may vary from OPCON, TACON, or support, depending on the situation. However, there are situations in which SOF will operate directly under a GCC or another JFC, not the TSOC, with either an OPCON, TACON, or support relationship.

### Role of the TSOC Commander

The TSOC commander (CDRTSOC) has three primary responsibilities on a routine basis: (1) serve as the principal SOC advisor to the GCC, (2) maintain an AOR-wide focus and employ SOF to support the GCC’s AOR requirements, and (3) serve as an operational commander, providing C2 of SOF in the AOR.

On a routine basis, the CDRTSOC exercises C2 of assigned and attached SOF in the AOR. During a

contingency or crisis, this responsibility is expanded, with the CDRTSOC having to determine and make recommendations to the GCC and/or JFC on the SOF C2 structure (e.g., Joint Special Operations Task Force, Joint Force Special Operations Component, or a combination of these) required for the operation and on what organization should form and command the operation.

**Joint Force Special Operations Component.** A JFSOC is a command within a unified command, sub-unified command, or JTF responsible to the establishing joint force commander (GCC, TSOC, or JTF) for making recommendations on the proper employment of assigned, attached, and other forces made available for tasking; planning and coordinating special operations; and accomplishing assigned missions and taskings. The JFSOC is not a joint force. It is a component of a joint force.

**Joint Special Operations Task Force.** A JSOTF is a joint force—a JTF—composed of SOF from more than one service, formed to plan and conduct a specific special operation or prosecute special operations in support of a theater campaign or other operations. It may have both SOF and conventional forces.

The decision on the SOF C2 structure (JSOTF or JFSOCC) should be based on the following considerations: mission requirements, higher HQ concept of operation and organizational structure (e.g., functional components, JTFs, etc.), battlespace geometry, SOF concept of operation and force structure, C2 requirements, multinational implications, etc. There are several options to consider when determining what organization should form the SOF C2 organization and command the operation. Some of the options include: a TSOC battlestaff, a battlestaff of one of the TSOC's components, one of the JTF level SOF C2 elements provided by USSOCOM, and an ad hoc organization. The decision on who should form and command the organization should be based on the following considerations: mission requirements, mission response time/time available to prepare, experience and readiness level, anticipated duration of the operation, multinational implications, etc.

### ***Forming a SOF Command and Control Structure (JSOTF or JFSOCC)***

In a situation that requires rapid response, the GCC may decide, based on the CDRTSOC's recommendation, to task the TSOC to form and deploy a JSOTF to C2 the operation. That JSOTF could either operate directly under the C2 of the GCC or the TSOC, depending on the operational requirements. If the situation continues to develop and a larger JTF is required, the JSOTF may transition overall C2 of the operation to a larger JTF. The JSOTF may then become subordinate to the JTF, with a command relationship (OPCON, TACON, or support) established by the GCC.

If a GCC forms a JTF to C2 an operation, the TSOC Commander will advise the GCC and JTF Commander on the SOF C2 structure as discussed earlier. The JTF may have one or more JSOTFs, depending on the overall concept of operation and the operational requirements. If the JTF has more than one JSOTF, the JTF Commander may decide to either keep the JSOTFs separate

and directly subordinate to the JTF, designate one of the JSOTFs as the lead and have the other JSOTFs subordinate to it, or form a functional component for special operations, a JFSOC, in order to enhance the integration of the planning efforts, reduce the JTF Commander's span of control, and improve combat efficiency, information flow, unity of effort, asset management, component interaction, and operations. If a JTF Commander decides to operate through subordinate functional components, such as a JFLCC, JFMCC, and JFACC, he will normally also establish a JFSOCC. The JFSOCC could C2 one or more JSOTFs or be the single operational level SOF headquarters, exercising C2 over subordinate special operations task forces (SOTFs).

For a large-scale operation, a GCC may decide to C2 the operation directly from the GCC headquarters. In these situations, a GCC may decide to operate through subordinate functional components, such as a JFLCC, JFMCC, and joint force air component commander (JFACC). He may also decide to establish a JFSOCC. As in a JTF, the JFSOCC could C2 one or more JSOTFs or be the single operational level SOF headquarters, exercising C2 over subordinate SOTFs.

### ***SOF as the Lead for a Joint Task Force***

With the increased IW nature of operations and a whole-of-government effort in unified action to defeat global, networked, and transnational irregular adversaries, there may be cases where the C2 construct based on preponderance of forces may not be the primary consideration in establishing a JTF. In some cases, a C2 construct based on special operations expertise and influence may be better suited to the overall conduct of an operation (i.e., superiority in the aggregate of applicable capabilities, experience, specialized equipment, and knowledge of and relationships with relevant populations), with the JTF being built around a core special operations staff. Such a JTF has both SOF and conventional forces and the requisite ability to command and control them. SOF and their unique capabilities are particularly well-suited for such complex situations because of their regional familiarity, language and cultural awareness, and understanding of the social dynamics within and among the relevant populations (i.e., tribal politics, social networks, religious influences,

and customs and mores). SOF also maintain special relationships with other participants within unified action. Given the SOF expertise and the special operations form of “maneuver,” SOF may be best suited to lead U.S. forces in some operational areas. Accordingly, an optimal construct can be one having a SOF chain of command supported by conventional forces and their enabling functions. *Such a construct calls for a SOF JFC, not as a JFSOCC/CDRJSOTF, but as the CJTF.*

### Notional Organization of a JSOTF

A JSOTF does not have a fixed organization. Like conventional JTFs, a JSOTF is normally task-organized based on mission requirements, and its organization is flexible in both size and composition. However, a JSOTF is normally composed of service components (e.g., USASOC, AFSOC, NAVSOC, and MARSOC), subordinate JTFs (e.g., JSOTF, JPOTF/JMISTF), and a joint special operations air component (JSOAC) as functional component. Recent operations and current JSOTF doctrine include Special Operations Task Forces (SOTFs) in a JSOTF task organization. SOTF is a general term used to describe an operational task force of varying compositions subordinate to a JSOTF. A JSOTF headquarters also varies in size as well as scope, but is normally able to perform the command and staff functions required of a joint headquarters. Most JSOTF headquarters and staffs have a functional J-code structure (e.g., J1, J2, J3, J4, J5, J6, etc.). In addition to the separate J-code directorates, most JSOTF staffs establish and maintain several of the cross-functional staff organizations that directly enhance planning and decision-making, such as a joint planning group, joint

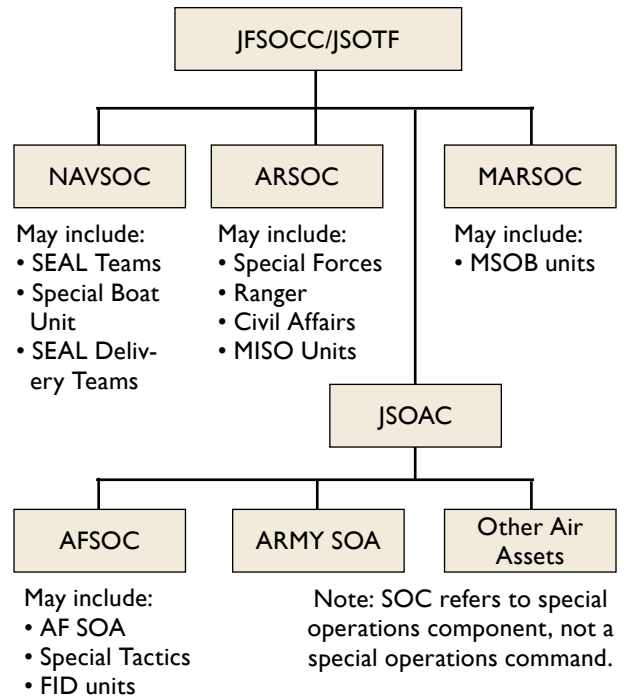

Figure 2-23. Notional JSOAC under a JFSOCC

targeting board, joint operations center, joint logistics center, joint personnel recovery center, etc. A JSOTF does not normally have the requirements or the ability to establish and maintain all of the cross-functional staff organizations normally associated with a larger conventional JTF. Notional depictions of a JFSOCC/JSOTF and JSOTF elements are shown in figures 2-21 and 2-22. An existing application of a SOJTF is described at the end of this chapter and depicted in Figure 2-23.

### Joint Special Operations Air Component (JSOAC)

The JSOAC is the SOF functional air component. A CDRTSOC, JFSOCC, or CDRJSOTF may designate a joint special operations air component commander (JSOACC) to plan and execute joint special operations air activities, and coordinate conventional air support for SOF with the JFACC, if designated. The JSOACC will normally be the commander with the preponderance of SOF air assets or the best capacity to plan, coordinate, allocate, task, control, and support the assigned and supporting air assets, which can include Army SOA, AFSOF, and other air assets. SOF commanders may place selected SOA assets under CF control. A

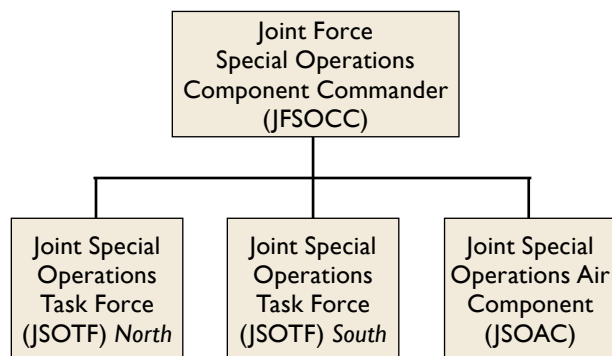

Figure 2-22. Notional Joint Force Special Operations Component Command and Control



JSOACC may support multiple JSOTFs in one or more operational areas in a theater of operations. A JSOAC may be a standing organization, or formed in response to a crisis, or for a major operation or campaign. Normally, the only SOF functional component under a CDRTSOC, JFSOCC, or CDRJSOTF is a JSOAC. The other components are Service components.

### ***SOF Integration with Conventional Operations and Forces***

To fully integrate with conventional operations, SOF must maintain effective liaison and coordination with all components of the joint force that may impact the conduct of SOF activities. Unity of effort among SOF and conventional forces is accomplished through a number of integrating elements. These are described below.

**Special Operations Command and Control Element (SOCCE).** The SOCCE is a command and control element generally based on a U.S. Army Special Forces Company headquarters (SFOD-B) or a Ranger Liaison Element and usually found at a corps or Marine Air-Ground Task Force level. The SOCCE integrates special operations (less MISO and CMO) with land or maritime operations and normally remains under the control of the JFSOCC. The SOCCE is the focal point for synchronizing and deconflicting SOF missions with ground and maritime operations. The SOCCE collocates with the command post of the supported commander and performs C2 or liaison functions as directed by the JFSOCC. The SOCCE can also receive SOF operational, intelligence, and target acquisition reports directly from deployed SOF elements and provide them to the land force headquarters.

**Special Forces Liaison Element (SFLE).** The SFLE is a U.S. Army Special Forces or Joint special operations element that conducts liaison between U.S. conventional forces division-level headquarters and subordinate HN or multinational forces brigades and battalions. It is formed only as needed. SFLEs conduct these functions when host or multinational forces have not practiced interoperability before the operation, if they do not share common operation procedures or communications equipment, or if a significant language or cultural barrier exists.

**Special Operations Liaison Element (SOLE).** A SOLE is a team provided by the JFSOCC or the JSOTF commander to the JFACC or appropriate service component air C2 organization. A SOLE is provided to coordinate, deconflict, and integrate special operations air, surface, and subsurface operations with conventional air operations.

This team is composed of operations, plans, and liaison officers from the different SOF air and ground elements and is led by a senior SOF airman known as the director. The SOLE director works directly for the JFSOCC. The SOLE director is not in the SOF chain of command, and thus command authority for mission tasking, planning, and execution of special operations remains with the JFSOCC. The SOLE director places SOF ground, maritime, and air liaison personnel in divisions of the Joint Air Operations Center to integrate with the JFACC staff. The SOLE accomplishes the coordination, deconfliction, and integration of SOF air, surface, and subsurface operations by providing a SOF presence in the joint air operations center that is aware of the activities of SOF units in the field and by providing visibility of SOF operations in the air tasking order and the airspace control order. The SOLE must also coordinate appropriate fire support coordinating measures to help avoid fratricide. A notional SOLE consists of 43 personnel, but in practice is tailored as appropriate.

**Naval Special Warfare Task Unit (NSWTU).** These provisional subordinate units of a Naval Special Warfare Task Group (NSWTG) provide command and control, coordinate administrative and logistical support, and integrate special operations with maritime operations. Designated Naval Special Warfare (NSW) forces may be under the operational control of the naval component commander or a JFSOCC. NSW forces are often assigned to conventional naval component commanders, as well as to theater JFSOCCs. Several NSWTUs could be operationally subordinate to a NSWTG, as well as having an NSWTU under the OPCON of a JFSOCC.

**Special Operations Commands Forward (SOCFWD).** SOCFWDs are command nodes of varying sizes resident in GCC AORs. These nodes link the TSOCs to forward deployed tactical SOF units that execute distributed special operations and provide a SOF voice and influence to JTF and Chiefs of Mission activities. They are



Leaflets from Operation Odyssey Dawn/Unified Protector

an extension of the TSOCs and they develop a cadre of campaign experts who rotate between the SOCFWD node and the TSOC. SOCFWDs are intended to improve SOF relationships with other agency partners and allies. There are currently small SOCFWD command nodes in Lebanon, Jordan, Pakistan, and Yemen.

**Special Operations Forces Liaison Element (SOFLE).** The USSOCOM-Marine Expeditionary Unit/Amphibious Ready Group (MEU/ARG) SOFLE is provided to deploying MEU/ARGs to improve access, leverage the SOF network, enable TSOC coordination, and facilitate interdependent MEU/ARG-SOF objectives, actions, and activities (OAA) in order to better support GCCs' steady state and crisis response operations.

**Special Operations Liaison Officers (SOLO).** SOLOs are in-country SOF advisors to the U.S. country team. They advise and assist partner nation SOF in the development of partner nation SOF activities and synchronize activities between the HN and the United States. There are SOLOs in Australia, Brazil, Canada, United Kingdom, Jordan, Poland, Colombia, France, Turkey, Kenya, and Italy.

### Joint Military Information Support Task Force (JMISTF)

Operational planning for MISO resides at the GCC due to its importance to the commander's strategic concept. The TSOC, as a sub-unified command of USSOCOM, usually exercises operational control of U.S. Army Active Component (AC) military information support (MIS) forces when they are allocated and attached to the GCC. The TSOC commander may become the principal advisor to the supported CDR for MISO. When a CDR establishes a subordinate JTF, MISO positions are allocated to the TSOC or JFC's staff. The inclusion of these positions on the JFC's staff ensures nesting of supporting MISO plans with the CDR's plan. As a JFC, the TSOC commander can direct the establishment of a JMISTF to plan and conduct operations within the theater when approved by the GCC. Requests for MIS forces are staffed through the SecDef in the same manner that other forces are requested.

During planning, CDRs identify the capabilities required to execute their assigned missions. CDRs establish subordinate joint forces and designate the required subordinate components. The requested MIS force size and planned disposition may exceed the command and control (C2) capabilities of the joint force components. In these cases, the CDR may identify the requirement to establish a JMISTF or military information support task force (MISTF) as a component of the joint force. The CDR may decide to establish the (J) MISTF or JMISTF as a component of an existing joint force component, such as a joint special operations task



A MISO soldier in Baghdad distributes leaflets to civilians warning them not to touch unexploded ordnance.

force (JSOTF) or special operations task force. MIS forces may be organized as large as a battalion sized JMISTF or as small as a military information support team.

The JMISTF is responsible for integrating MISO into joint or multinational operations at the tactical and operational levels. During planning, the JMISTF coordinates with applicable services, functional components, and staff elements to determine MISO requirements. During execution, the JMISTF continues this coordination. The JMISTF commander may request direct liaison authority to coordinate and synchronize operations with other U.S. government departments or agencies, or multinational officials.

The JMISTF is also responsible for deconflicting all MISO that occur under the JTF and other commands as designated by the establishing authority. Deconfliction is accomplished through the MISO approval process, establishment of direct coordination lines, liaison, and the synchronization conducted by IO staffs. In the absence of a MIS component, the requirement to deconflict MISO is executed in the same manner as all operations are, in the operations staff sections.

Mission requirements dictate the JMISTF organizational structure and the functions conducted. It also may be organized as a combined joint military information support task force (CJMISTF) if multinational partners provide MIS staff personnel and forces to support operations.

A CJMISTF supports multinational military operations, as well as operations involving intergovernmental and regional organizations. OPCON of all assigned MIS forces to the JMISTF commander or may exercise OPCON of specified MIS forces through the commander of the units or components to which they are attached or assigned. A subordinate JFC can only delegate OPCON of those MIS forces for which the JFC has OPCON.

If the JFC determines that MISO planning and execution requires control by a component command with that mission as its sole purpose, then the JFC requests establishment of a JMISTF or MISTF. JMISTFs can serve as a component of staff element of the JFC or as a subcomponent or staff element under an existing component such as a JSOTF. Control should favor centralized planning and direction and decentralized execution. Control is exercised from the lowest level



A U.S. Marine prepares leaflets in Afghanistan.

that accomplishes the required coordination. Considerations for MISO may dictate that control be at high national levels.

Dissemination assets, primarily AC and Reserve Component (RC) MIS teams, may be attached in CONUS to deploying units, attached in theater based on mission requirements, or deployed with the JMISTF and remain in support of the entire joint force.

### *Joint Civil-Military Operations Task Force (JCMOTF)*

A JCMOTF is a U.S. joint force organization, similar in organization to a JSOTF or JTF and is flexible in size and composition, depending on mission circumstances. It usually is subordinate to a JTF but, in rare instances and depending on resource availability, could be formed as a standing organization. A JCMOTF can be formed in theater, in the United States (within the limits of the law), or in both locations, depending on scope, duration, or sensitivity of the CMO requirement and associated policy considerations.

JFCs are responsible for conducting CMO and may establish a JCMOTF when the scope of CMO requires coordination and activities beyond that which a staff CA representative could accomplish. The JCMOTF will be resourced to meet the JFC's specific CMO requirements (for example, stability operations). To support the conduct of specific missions, a JCMOTF may have both conventional and SOF assigned or attached. By design, the U.S. Army active component CA brigade, U.S. Navy Maritime Civil Affairs Group, or Marine Corps Civil

Affairs Group organizational structure can provide the operational C2 system structure to form a JCMOTF.

JCMOTF responsibilities typically include the following:

- a. Advising the JTF commander on policy, funding, and multinational, foreign, or HN sensitivities and their effect on theater strategy and/or campaign and operational missions
- b. Providing C2 or direction of military host-nation advisory, assessment, planning, and other assistance activities of joint U.S. forces
- c. Assisting in establishing U.S. or multinational and military-to-civil links for greater efficiency of cooperative assistance arrangements
- d. Performing essential coordination or liaison with HN agencies, country team, United Nations agencies, and deployed U.S. multinational, and HN military forces and supporting logistic organizations
- e. Assisting in the planning and conduct of civil information programs to publicize positive results and objectives of military assistance projects, to build civil acceptance and support of U.S. operations, and to promote indigenous capabilities contributing to recovery and economic-social development
- f. Planning and conducting joint and combined civil-military operations training exercises
- g. Advising and assisting in strengthening or stabilizing civil infrastructures and services and otherwise facilitating transition to peacekeeping or consolidation operations and associated hand-off to other USG agencies, international organizations, or HN responsibility
- h. Assessing or identifying HN civil support, relief, or funding requirements to the CJTF for transmission to supporting commanders, military services, or other responsible USG agencies
- i. Establishing combat identification standing operating procedures

### **NATO Special Operations Component Command-Afghanistan/Special Operations Joint Task Force-Afghanistan (NSOCC-A/SOJTF-A)**

**Mission.** NATO Special Operations Component Command Afghanistan/Special Operations Joint Task Force-Afghanistan (NSOCC-A/SOJTF-A) conducts special operations activities within the Coalition Joint Operations Area - Afghanistan (CJOA-A), in order to enable the International Security Assistance Force (ISAF), the Afghan National Security Force (ANSF), and the Government of the Islamic Republic of Afghanistan (GIROA) to provide the Afghan people a secure and stable environment and to prevent insurgent activities from threatening the authority and sovereignty of GIROA. In addition, SOJTF-A conducts special operations to deny terrorist sanctuaries in Afghanistan that threaten Western interests. See Figure 2-23.

#### **SOJTF-A Organization**

**International Security Assistance Force Special Operations Forces (ISAF SOF)** is building enduring tactical, operational, and institutional capabilities with Afghan Special Police and designated specialist security elements with Afghan rule of law, in order to neutralize insurgent networks, protect the population, and set the conditions for the transfer of responsibility to our Afghan partners.

**Combined Joint Special Operations Task Force - Afghanistan (CJSOTF-A)** conducts FID throughout Afghanistan to build a sustainable and independently capable GIROA capacity for security, governance, and development.

**Task Force** - Conducts offensive operations in Afghanistan to degrade the Taliban, al-Qaeda, and the Haqqani Networks in order to prevent them from establishing operationally significant safe havens that threaten the stability and sovereignty of GIROA and the United States.

**Combined Joint Special Operations Aviation Component - Afghanistan (CJSOAC-A)** conducts special and conventional aviation operations to include assault, fires, Intelligence Surveillance and Reconnaissance, and mobility within the CJOA-A in support of the SOJTF-A commander taskings and priorities.

**Village Stability Operations (VSO).** VSO was a bottom-up COIN strategy that establishes expanding security and stability in rural villages. As the security bubble expands outward, more and more “white space” is created that is inhospitable to the insurgents and allows the establishment and solidification of legitimate local governance and development. As these security bubbles expand and connect, they simultaneously force the insurgents out and connect local governance to the district government, and district governance to the national government. At the heart of VSO is a SOF element that embeds in the village. The element moves into a local house or compound and lives there 24/7.

**Afghan Local Police (ALP).** As part of VSO, the ALP program is an Afghan Ministry of the Interior-sponsored, village-focused security program that complements COIN efforts by assisting and supporting rural areas with limited to no ANSF presence in order to enable conditions for improved security, governance and development. The ALP program is a vital extension of broader VSO efforts. Participants in the ALP program are selected through the shura process and are accountable to their village elders, the district chief of police and the Afghan Ministry of the Interior. Without VSO, an effective ALP program cannot exist.

**Afghan National Army Commandos.** Commandos conduct specialized light infantry operations in support of regional corps COIN operations, and provide a strategic response capability for the Government of Afghanistan. The Commando Kandak (battalion) plans and conducts special military operations in support of Afghan security policy and objectives. Its specially organized, equipped, and trained soldiers provide the Ministry of Defense the capability to rapidly deploy a credible military force to any region of Afghanistan. Additionally, commandos may be called upon to perform missions in support of general purpose forces. Commando operations fill a capability gap in remote or high threat locations where regular Afghan security forces have limited capabilities to accomplish required tasks. Commando Training mirrors that of the U.S. Army Rangers and they function as a light infantry assault force. They can perform a number of other specialized missions and are paired with a Special Forces Team for both training and operations.

**Partnered Forces.** Service members with CJSOTF-A work in a close partnership with members of the Afghan National Army Special Forces (ANASF) and the Afghan National Army Commandos, as well as other Afghan security force partners. Service members help train and mentor Afghan forces to be better prepared to take charge of their own security in the near future. Operations are now undertaken with Afghan forces taking the lead, and SOF acting more in an advisory capacity.

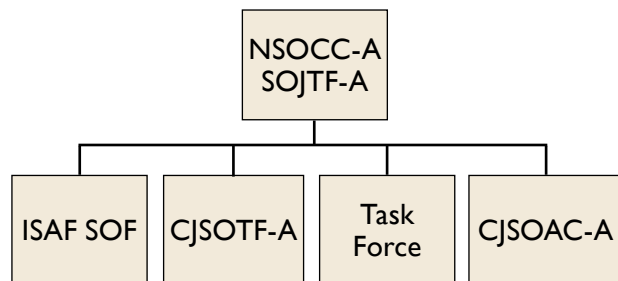

Figure 2-24. NSOCC-A/SOJTF-A Organization

# Chapter 3. U.S. Army Special Operations Forces

## United States Army Special Operations Command (USASOC)

“Reorganization focuses on the institutional change with the intent to increase efficiency, improve alignment of operational force generation capabilities within the U.S. Army and USSOCOM, and create new operational-level capabilities.”  
 – USASOC Commander, Lieutenant General Charles T. Cleveland

The U.S. Army Special Operations Command (USASOC) at Fort Bragg, North Carolina, provides Special Forces (SF), Ranger, Special Operations Aviation, Military Information Support Operations, and Civil Affairs forces to USSOCOM for deployment to combatant unified commands around the world. USASOC commands active Army SOF. It also provides oversight of Army National Guard SOF readiness, organization, training, and employment in coordination with the National Guard Bureau and State Adjutants General.



The Department of the Army established USASOC on 1 December 1989 as an Army Service Component Command (ASCC) to enhance the readiness of Army SOF (ARSOF). As an ASCC, USASOC reports to the Department of the Army for service guidance.

The command conducts a total of 64 courses and trains over 16,000 students per year. Courses range from combat skills courses such as sniper, military free fall and combat diver to language and warrant officer professional development courses.

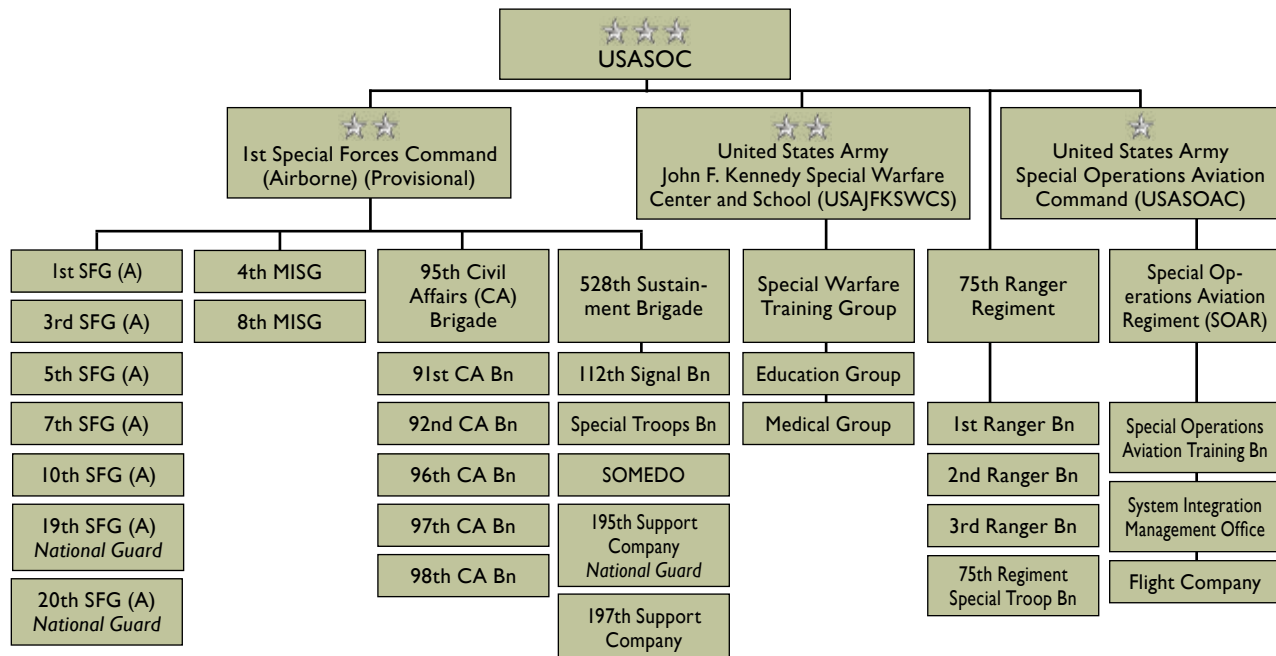

Figure 3-1. USASOC Organization Chart

## 1st Special Forces Command (Airborne) (Provisional) – 1st SFC (A) (P)

The establishment of 1st SFC (A) (P) consolidates all special warfare elements within the USASOC underneath a singular, two-star headquarters. The Force Structure redesign includes all elements within the Special Forces Regiment, the active component units of the Psychological Operations Regiment, the 95th Civil Affairs Brigade, and the 528th Sustainment Brigade, and will focus on organizing, training, equipping, validating, and deploying regionally-expert, campaign-capable special warfare elements in support of the TSOs, JFCs, U.S. ambassadors, and other government agencies. 1st SFC (A) (P) is enabled by the consolidation of the MISO Command and U.S. Army Special Forces Command (A) to streamline the SOF enterprise to better fulfill TSOC commander requirements.

SF operations are characterized by their strategic and operational implications. Unique SF skills in language qualification, regional orientation, cultural awareness, and interpersonal relations are keys to the successes experienced by SF units in the field. SF operations require flexible and versatile forces that can function effectively in diverse and complex environments. Examples include counterdrug operations in Latin America, support of Operation Enduring Freedom in Afghanistan and Operation Iraqi Freedom, joint commission observers in Bosnia, humanitarian mine action initiatives, JCET initiatives worldwide, and training foreign military forces in peacetime operations. Blending their skills and expertise enables SF soldiers to navigate in ambiguous environments that affect the political, social, religious, and humanitarian aspects of today's uncertain environment.

### Special Forces Regiment

#### Tasks

SF soldiers are carefully selected, specially trained, and capable of extended operations in extremely remote and hostile territory. They train to perform

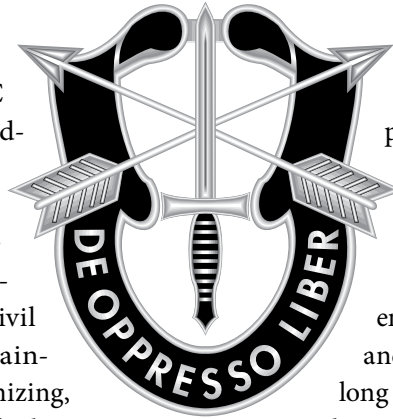

nine principle tasks assigned to SF: UW, FID, SFA, counterinsurgency, DA, SR, CT, counterproliferation, and preparation of the environment. While SF soldiers are capable of performing all of these missions, an increasing emphasis is being placed on UW and coalition warfare and support. UW encompasses a broad spectrum of military and paramilitary operations, normally of long duration, predominantly conducted by indigenous or surrogate forces that are organized, trained, equipped, supported, and directed in varying degrees by an external source. It includes guerrilla warfare and other offensive low-visibility, covert, or clandestine operations, as well as the indirect activities of subversion, sabotage, intelligence activities, and evasion and escape.

Coalition warfare and support draws upon the SF soldier's maturity, military skills, language skills, and cultural awareness. It ensures the ability of a wide variety of foreign troops to work together effectively in a wide variety of military exercises or operations such as Operation Desert Storm.

#### Organization

The command, through the Special Forces Regiment, exercises command and control over five active component and two Army National Guard groups; see figure 3-7. Additionally, USASFC(A) exercises training oversight of two Army National Guard groups. Each Special Forces group (SFG) is regionally oriented to support one of the geographic combatant commanders. SF are U.S. Army forces organized, trained, and equipped to conduct special operations, with an emphasis on UW capabilities. SF is a unique, unconventional, combat arms organization. These forces are highly trained and experienced professionals with an extraordinary degree of versatility. They can plan and conduct special operations across the full range of military operations. Their tactical actions may often have strategic or operational effects. The USASFC(A) comprises the largest combat force under USASOC.

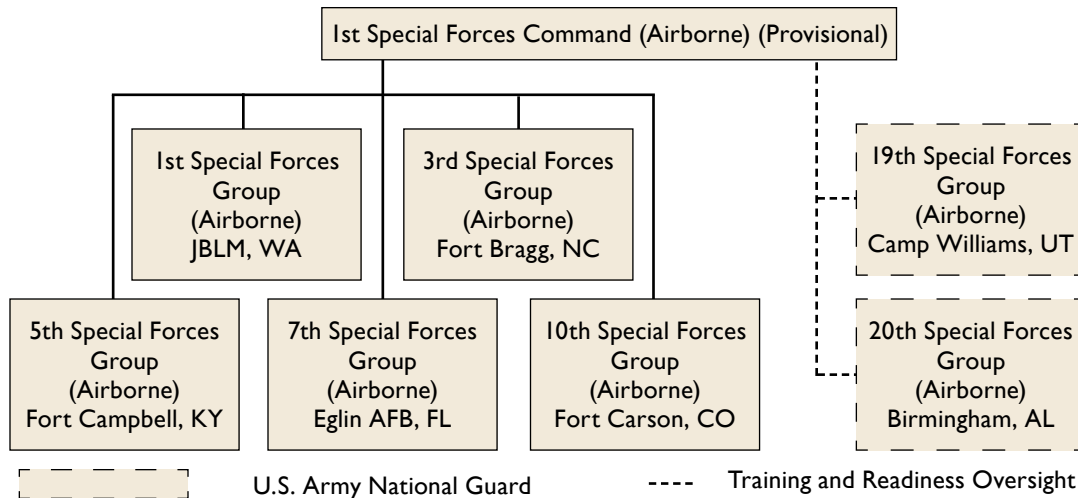

Figure 3-2. United States Army Special Forces Regimental Command Structure

Special Forces Group (Airborne) AORs and locations are as follows:

- a. 1st SFG(A)
  - 3 Battalions, Joint Base Lewis-McChord, Washington
  - 1 Battalion, Okinawa, Japan
- b. 3rd SFG(A)
  - 4 Battalions, Fort Bragg, North Carolina
- c. 5th SFG(A)
  - 4 Battalions Fort Campbell, Kentucky
- d. 7th SFG(A)
  - 4 Battalions, Eglin AFB, Florida
- e. 10th SFG(A)
  - 3 Battalions Fort Carson, Colorado
  - 1 Battalion Stuttgart, Germany
- f. 19th SFG(A)
  - Camp Williams, Utah
- g. 20th SFG(A)
  - Birmingham, Alabama

### Special Forces Group (Airborne)

#### Special Forces Group (Airborne) Task

Plan and support special operations in any operational environment in peace, conflict, and war as directed by the President and/or the SecDef.

#### Special Forces Group (Airborne) Organization

The SFG(A) is composed of one headquarters and headquarters company, one group support battalion,

and four Special Forces battalions. The SFG(A) is the largest combat element of Army SOF, and all assigned personnel are airborne qualified.

The SFG(A) is an extremely flexible organization designed to have self-contained C2 and support elements for long-duration missions. Because of this, the SFG(A) has the capability to form the nucleus of the SOTF or a JSOTF. If augmented, the SFG(A) may exercise OPCON of conventional force units.

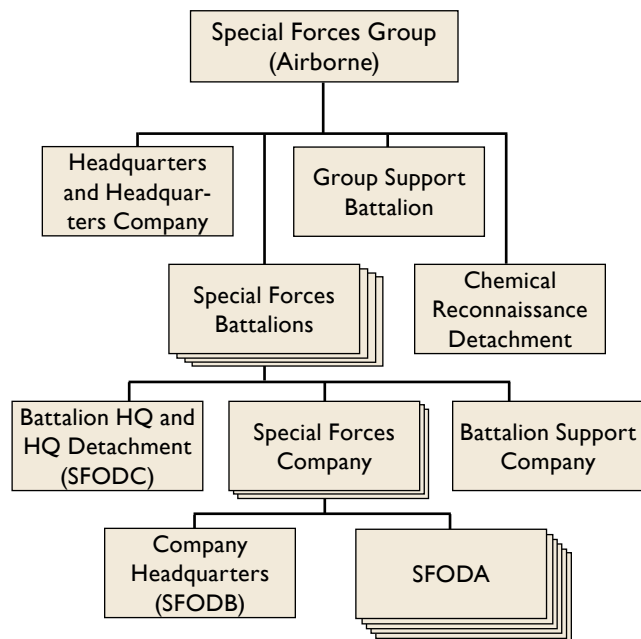

Figure 3-3. Special Forces Group (Airborne) Organization



### *Special Forces Group (Airborne) Capabilities*

- a. C2 of Special Forces battalions and support elements
- b. Function as an SOTF or JSOTF when augmented by resources from other services
- c. Establish, operate, and support 4 SOTFs
- d. Train and prepare operational elements for deployment
- e. Infiltrate and exfiltrate specified operational areas by air, land, and sea

### *Special Forces Group Support Battalion (GSB)*

The multifunctional GSB provides logistical support to SFGs and attached units, and it ties together the entire sustainment spectrum of supplies, maintenance, and services. The GSB commander is the group commander's senior battle logistician and serves as the single logistics operator for support to the SFG(A). This concept allows the SFG commander and his staff to focus on the war, while the GSB commander executes the SFG commander's concept of logistical support. Much like the SF warrior, the GSB logistician is a dedicated professional logistician whose primary focus is "sustaining the SOF warrior."

#### *Group Support Battalion Task*

The SF GSB plans, coordinates, and executes logistical sustainment operations for the SFGs, and when directed, will support forces attached or assigned to a predominantly SF JSOTF. The GSB controls consolidated logistical facilities and activities when the SOTFs and Army forward operating bases (FOBs) consolidate sustainment operations. It also augments the resources of the battalion support companies when subordinate battalions establish SOTFs.

The GSB provides common-user and SOF-peculiar logistical direct support for field feeding, fuel, bare-base operations, ammunition, force health protection (FHP), maintenance, limited transportation, aerial delivery, water production, common supplies, chemical decontamination, communication, intelligence, and operations support to the SFG.

The GSB has significantly less force structure and capabilities than a brigade support battalion. The GSB plans and coordinates logistical operations with the TSOC, SB(SO)(A), SC(T), and the ASCC. Logistics



Soldiers of 1st Special Forces Group (Airborne) and the Republic of Korea 11th Special Forces Brigade provide security for their fellow members during training near Gwangyang, South Korea, 1 April 2009.

replenishment operations conducted by the SC(T) are critical for sustainment of SOF that are often deployed into isolated, austere, and non-permissive locations. Failure to provide support to SOF places the JFC's concept of operations at risk of failure. During the early phase of JSOTF operations, before SC(T) forces deploy, the GSB provides C2 of all logistic operations and forces within the AO.

The GSB is joint and multinational capable in that it can accept augmentation of, and employ, common user logistical assets from other services and nations and integrate their capabilities into a cohesive plan supporting the JSOTF commander's operational concept. The GSB is capable, with replenishment, of supporting all of the SFGs' logistical requirements. With augmentation from the SC(T) or other services and nations, the GSB can integrate their capabilities for common user logistics (CUL) support for component forces of the CDRJSOTF. When component forces are assigned to a JSOTF, they will provide their organic support packages for service-specific requirements and CUL support.

The GSB and SF battalion support companies may require Army logistics augmentation to provide support during sustained operations, or for a capability not organic to the SFG. This augmentation may be necessary when:

- a. The SOTF and Army FOBs are in undeveloped theaters without established Army theater opening, theater distribution, or area support.

- b. The SOTF bases and Army FOBs are not established at fixed facilities.
- c. A high percentage of SF operational detachments are committed simultaneously.

The SFG has the most robust FHP structure of any ARSOF unit. It usually has several physicians and physician assistants assigned at the group and battalion levels. Each Special Forces Operational Detachment "A" is authorized 2 SF medical sergeants. However, similar to other light units, staffing depends on theater or SB(SO)(A) FHP assets.

#### **Group Support Battalion Organization**

The GSB consists of a group service support company (GSSC) and a group support company (GSC). The GSSC is a multifunctional logistics organization consisting of a HQ, sustainment platoon, distribution platoon, field maintenance platoon, and medical platoon. The GSC has organic signal, military intelligence, and chemical decontamination detachments. The GSSC functions as the HQ company for the GSB and depends on the HHC, SFG, for administrative and ministry support.

#### **Limitations of the Group Support Battalion**

The GSB is not designed to provide all or even part of the logistics functions listed in the following paragraph. To obtain these services for a prolonged deployment the GSB must tie into the Army Service Sustainment Command.

A requirement exists to plan for and receive augmentation based on METT-TC to accomplish the assigned mission. Assessing the mission and task organization of the GSB is critical in every mission analysis. Factors and limitations to be considered are as follows:

- a. Urban areas, dense jungles and forests, steep and rugged terrain, and large water obstacles limit movement
- b. The GSB has no organic mortuary affairs capability for collection, processing, and evacuation without augmentation
- c. Laundry and bath is not organic to the SFG; support is provided by the SB(SO)(A) or SC(T)

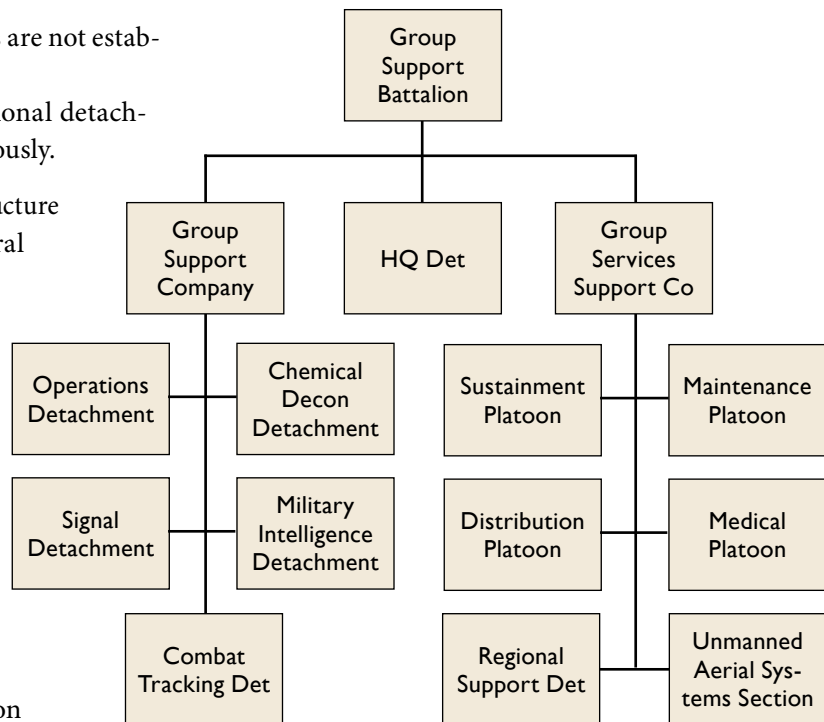

Figure 3-4. Group Support Battalion Organization

- d. Limited financial management
- e. Limited Class VIII and IX storage
- f. Limited capability to reconfigure load; ammunition from EAB must be in strategic or operationally configured loads
- g. No firefighting capability
- h. Explosive ordnance disposal is not organic to the SFG, and requires augmentation from the ASCC
- i. Human resources other than its own unit S-1 HR operations; relies on the ASCC to provide additional critical wartime personnel support
- j. Legal support is limited to the assigned SFG; augmentation to support all Judge Advocate General functions is required
- k. Limited maintenance backup support to the battalion units
- l. No organic band support
- m. No optical fabrication and blood product management support
- n. No organic aeromedical evacuation support

## Special Forces Battalion (Airborne)

The Special Forces Battalion (Airborne) is made up of one battalion headquarters detachment (BN HQ DET/C DET), one support company, and three Special Forces companies. There is one Special Forces Operations Detachment (SFOD) Combat Diving A Detachment and one SFOD Military Free Fall A (SFODA) Detachment per battalion.

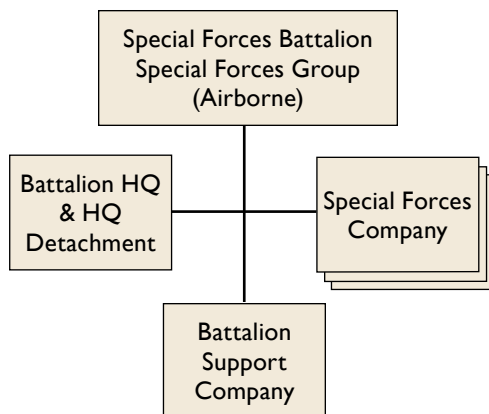

Figure 3-5. SFG(A) Battalion Organization

### Special Forces Battalion (Airborne) Personnel

The battalion HQ detachment is authorized 12 officers, 1 warrant officer, and 25 enlisted soldiers. The support company is authorized 4 officers and 75 enlisted soldiers. Each SF company is authorized 8 officers, 7 warrant officers, and 67 enlisted soldiers.

### Special Forces Battalion (Airborne) Task

To plan, conduct, and support special operations activities in uncertain, hostile, or permissive operational environments. The battalion HQ detachment (SFODC) commands and controls the activities of the SF battalion, and when deployed, is directly responsible for isolating, launching, controlling, sustaining, recovering, and reconstituting SFODAs.

### Special Forces Battalion (Airborne) Capabilities

The battalion's C2 and support elements can function as the headquarters for an SOTF when augmented by resources from the SFG(A). The C2 and support elements can:

- a. Provide special operations command and control element (SOCCEs) to supported

conventional headquarters, and operational elements as directed

- b. Establish, operate, and support a SOTF and up to three advanced operational bases
- c. Train and prepare SF teams for deployment
- d. Direct, support, and sustain deployed SF teams.

## Battalion Support Company

The SF battalion commander provides C2 for the battalion support company (BSC). The BSC is assigned and organic to the SF battalion. The BSC provides routine administrative and logistics support to the SF battalion HQ detachment, the company's organic or attached elements, and the SOTF support centers and signal centers. The support company commander oversees all personnel and elements assigned or attached to the company.

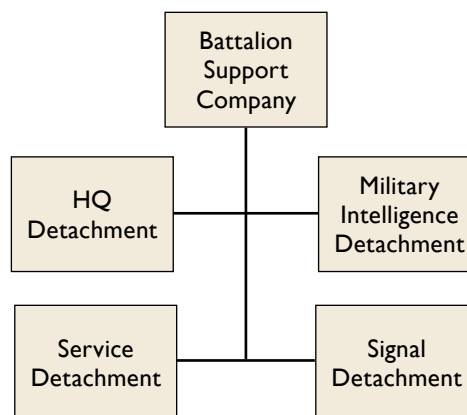

Figure 3-6. SFG(A) Battalion Support Company Organization

## Special Forces Company

The Special Forces company plans and conducts special operations activities in permissive, uncertain or hostile environments. The company HQ (SFODB) is an 11-man team. In garrison, the SFODB commands and controls its own organic SFODAs. The SF company commander is an experienced SF major. When deployed, the SFODB functions as a separate operational detachment conducting its assigned mission. The mission may require the SFODB to operate separately or to exercise OPCON of a mix of organic and attached SFODAs.

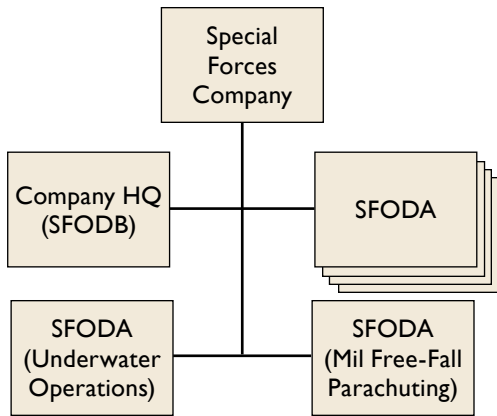

Figure 3-7. Special Forces Company Organization

### Special Forces Operational Detachment “A”

The basic building block of SF operations is the 12-man SFOD-A, also known as an A detachment or A team. All other SF organizations command, control, and support the SFOD-A.

#### Tasks

The SFOD-As’ primary task is to conduct UW as directed. They also have the capability to perform FID, CT, nonproliferation of WMD, DA, SR, and support of IO as directed.

#### Organization

The SFODA consists of two officers, an Army captain and a warrant officer. The senior enlisted member is a master sergeant. There are nine other enlisted team members. When required the SFODA can operate under the split team concept making up two six-man teams.

#### Methods of Infiltration

Special Forces soldiers possess the unique capabilities to infiltrate their target area by land, air, and sea.

**Land Infiltration/Exfiltration.** All SFODAs and six support operations team alpha (SOT-A) per SFG can infiltrate/exfiltrate an operational area by foot. Foot movement limiting factors include terrain, water availability, enemy presence, and soldier load. The SFODAs assigned to the 5th SFG and the 18 SFODAs assigned to the 3rd SFG are trained and equipped to infiltrate/exfiltrate

by ground mobility vehicles (GMVs). Selected SFODAs assigned to each group can infiltrate using high altitude/technical mountain techniques. Also, selected SFODAs from the 1st SFG and 10th SFG can infiltrate using ski techniques and mobile over snow transports.

**Air Infiltration (Static line Parachute).** Special Forces groups, Special Forces battalions, Special Forces companies, Operational Detachments-Alpha (OD-A), Operational Detachments-Bravo (OD-B), and Operational Detachments-Charlie (OD-C) are static line parachute qualified.

**Air Infiltration (Military Free Fall).** Nine ODAs per SFG (A) can infiltrate by employing military free fall high altitude low opening (HALO) or high altitude high opening (HAHO) techniques.

**Air Infiltration (Fixed-Wing and Vertical-Lift Aircraft).** ODC, ODB, and ODA personnel and equipment can infiltrate via fixed-wing and vertical-lift aircraft. Specific infiltration techniques include airland, rappel, and fast rope. Capabilities are only limited by aircraft capabilities and landing site availability.

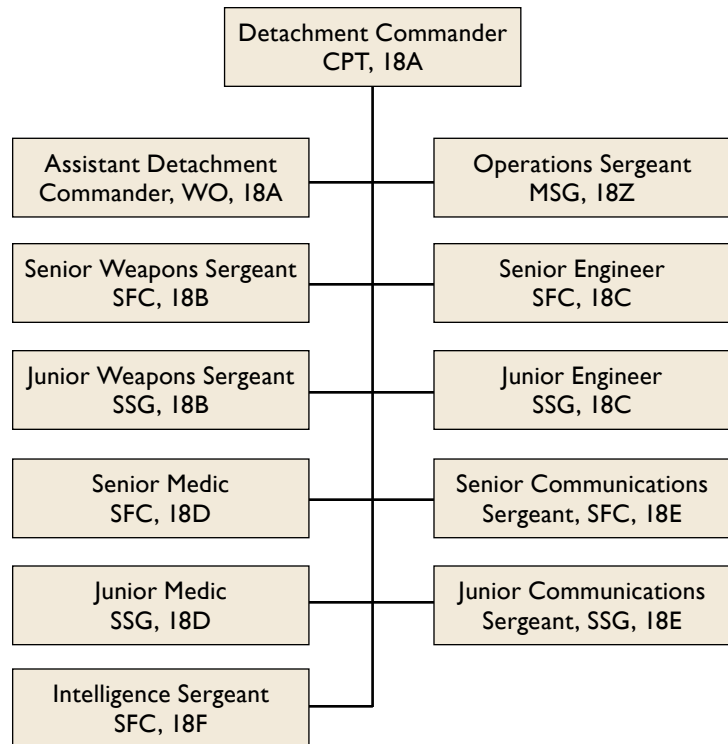

Figure 3-8. Special Forces Detach (SFODA) Organization

**Water Infiltration/Exfiltration.** All water infiltration techniques may be initiated from surface or subsurface mother craft, dropped by parachute from fixed-wing or vertical-lift craft, dropped by parachute from fixed-wing or vertical-lift aircraft. Up to six ODAs per SFG can infiltrate or exfiltrate using closed circuit breathing equipment or self-contained underwater breathing apparatus (SCUBA) open circuit equipment. Nine ODAs per

SFG are trained to infiltrate/exfiltrate by combat rubber raiding craft (CRRC). Twelve ODAs per SFG can infiltrate and exfiltrate by surface swim techniques. Unless specifically identified, the only teams with designated specialty skills are HALO and SCUBA teams. Other special skills, such as combat swim, are based upon the unit's mission essential task list (METL).



Afghan and American SF soldiers in Afghanistan

### ***Army National Guard - Special Operations Detachment (SOD)***

The Army National Guard's 19th and 20th Special Forces Groups (SFG) and seven Special Operations Detachments (SOD) directly support the COCOMs through USSOCOM. The groups and detachments also report to and support their respective state governors in state-directed operations such as disaster relief.

The National Guard Special Operations Detachments (NG SOD) directly support the TSOCs within each of the GCCs and USSOCOM. They provide the nucleus of a CJSOTF and have the ability to quickly multiply the theaters' capabilities. The SOD locations and alignments are as follows:

- SOD-A: (Texas) - SOCAFRICA
- SOD-P: (Washington) - SOCPAC
- SOD-C: (Florida) - SOCCENT
- SOD-E: (West Virginia) - SOCEUR
- SOD-S: (Mississippi) - SOCSOUTH
- SOD-J: (Maryland) - Joint
- SOD-G: (Rhode Island) - USSOCOM HQ
- SOD-K: (Colorado) - SOCKOR
- SOD-N: (California) - Projected 2016
- SOD-O: (North Carolina) - Projected 2016



Soldiers from the 20th Special Forces Group rescue a man trapped in his home by flooding caused by Hurricane Isaac in Moss Point, Mississippi, in August 2012.

### Military Information Support Operations (MISO)

ARSOF military information support operations (MISO) are organized under 1st SFC (A) (P).

#### Background

In December 2009 the USSOCOM Commander directed a comprehensive review of USSOCOM MISO organizational structures and how they execute their responsibilities to organize, train, equip, and execute MISO. On 10 June 2010, the USSOCOM Commander approved a new operating concept and special operations organizational structure to better support the force. Subsequent amplifying guidance on 11 April 2011 directed the deactivation of the USSOCOM Joint Military Information Support Command (JMISC) and the

reorganization of the 4th Military Information Support Group (MISG) to form a military information support operations command. U.S. Army Special Operations Command (USASOC) submitted a Force Design Update (FDU) to U.S. Army Training and Doctrine Command (TRADOC) on 13 April 2011 to establish the MISOC. In October 2014, the MISOC was deactivated and former command elements were incorporated into the 1st SFC (A) (P) and redesignated as MISO.

Composed of two groups of three battalions each, and a dissemination battalion in general support, the MISO is organized and trained to rapidly deploy units worldwide in support of SOF and conventional forces. Five battalions are aligned with GCC AORs with two regional companies. These battalions provide linguistic

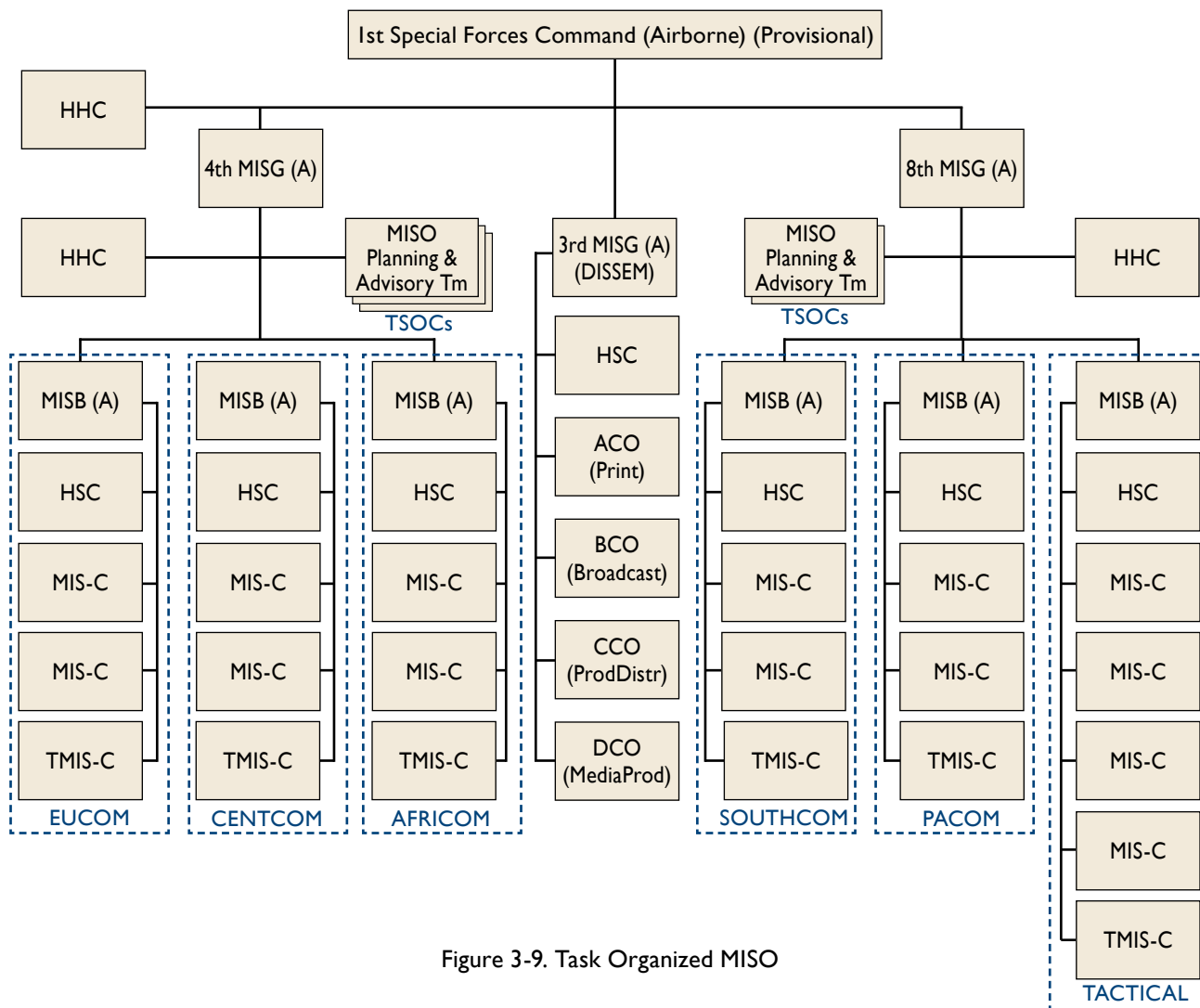

Figure 3-9. Task Organized MISO

and culturally attuned military information support teams (MIST) in support of U.S. Ambassadors and Embassy country teams. These regionally aligned battalions also form MISO task forces in support of JFCs. A sixth battalion composed of five tactical companies provides global support to JSOTF, other SOF units, and conventional forces units during crisis and contingency operations. Also fielded are MISO planning and advisory teams (MPATs) that provide direct support to TSOCs and GCC commanders and their staffs. The first TSOC MPAT was fielded in fourth quarter, FY11, with subsequent MPATs fielded in second and third quarter FY12. Component MPATs are fielded to support selected USSOCOM components. The first component MPAT was fielded in fourth quarter FY11, with subsequent MPATs fielded in second and third quarter FY12.

### *Purpose*

Every action has potential psychological impacts that may be leveraged to influence foreign individuals and groups. MISO contribute to the success of wartime strategies and are well-matched for implementation in stable and pre-conflict environments. MISO are applied across the range of military operations. As an influence capability, MISO consist of actions executed for psychological effect and messages delivered to selected foreign targets and audiences to achieve desired changes in attitudes and behaviors. MISO are also used to establish and reinforce foreign perceptions of U.S. military, political, and economic power, credibility, legitimacy, and resolve.

MISO are integrated to shape the security environment to promote bilateral cooperation, ease tension, and deter aggression. In peacetime, MISO are fully integrated with U.S. ambassador and GCC theater-wide priorities and objectives, and are used in conjunction with other U.S. measures to stabilize the region. MISO are an ideal means of conveying the intent of the GCC through supporting public diplomacy efforts, whether to foster relations with other nations or to ensure their collaboration to address shared security concerns.

In conflict, MISO as a force multiplier can degrade the enemy's relative combat power, reduce civilian interference, minimize collateral damage, and maximize the local populace's support for operations.

### *Military Information (MILINFO)*

The use of MISO to inform and influence foreign TAs in support of DOD activities and operations is MILINFO. The MILINFO mission is conducted across the range of military operations. MILINFO enhances operations during peacetime military engagements and is a combat multiplier during major combat operations. MISO are planned, integrated, synchronized, and executed as part of operations to defeat the enemy and influence the various TAs that shape OEs. Special operations MISO forces execute MILINFO while supporting special operations core activities as an integrated capability or as a main effort. When directed, special operations MISO forces also can support conventional units during the initial phase of contingencies. These forces can rapidly deploy (within 24 hours) to support crisis and contingency operations.

### *Interagency/Intergovernmental Support (IIS)*

MISO forces conduct the IIS mission to support interagency and intergovernmental operations and activities. IIS shapes and influences foreign decision making and behaviors in support of U.S. regional objectives, policies, interests, theater military plans, and contingencies. IIS is a special operations MISO forces' mission that leverages their regional and language expertise, planning capability, and media knowledge and capabilities. They conduct IIS in support of non-DOD information and public diplomacy efforts to communicate the U.S. narrative, and further regional, interagency, partner, and country team initiatives. IIS leverages regional expertise, planning capability, and media knowledge to support non-DOD information efforts to convey the U.S. narrative and further regional and country team initiatives and strategic communication. IIS facilitates non-DOD missions that support the GCC's theater campaign plan, Defense Support to Public Diplomacy, and Department of State (DOS) programs and activities. Special operations MISO forces conduct IIS when operating in foreign countries under the guidance of the American Embassy or similar USG entity, in association with the U.S. Embassy and the HN government, in permissive, uncertain, and hostile environments. Execution of this mission by conventional MISO forces is constrained both by their limited regional language training as well as Army



Reserve mobilization policies that necessitate detailed planning to support a persistent presence required to establish the relationships within both the supported American Embassy or other government agencies as well as relationships within the HN and partner nation government that are required for successful MISO.

#### *Civil Authority Information Support (CAIS)*

MISO Forces execute the CAIS mission as part of defense support of civil authorities when DOD information dissemination capabilities are requested by a lead federal agency in support of relief operations in the wake of natural and man-made disasters within the geographical area of the United States territories. The CAIS mission strictly consists of advising the commander on the use of MISO forces, planning the dissemination of public information for the lead federal agency, and delivering public information approved and provided by the lead federal agency to the local populace in affected areas. By DOD policy and practice, influence activities directed toward U.S. citizens are prohibited. Typically, information delivered during CAIS covers public safety issues and relief efforts, and is intended exclusively for those populations effected by the disaster and its related occurrences. Due to what are typically critical needs for timely action, special operations MISO units may be directed to deploy initially during relief operations as task-organized civil authority information support elements to provide direct support to the federal agency.

#### *Studies Programs*

The cultural intelligence element (CIE) is an important source of finished analytical intelligence products that are tailored to the needs of the entire MISO force, the GCCs, and the intelligence community. Finished products are primarily intended and designed to support the operational requirements of the combatant commands and of U.S. MISO forces worldwide, although they also are used by a variety of other organizations, such as the DOS.

These studies provide combatant commanders with MISO perspectives on issues of direct significance to peacetime strategy, joint operation planning, and operational preparations. Studies on all topics of interest can be requested through a combatant command's MISO staff officer or intelligence request for information

manager, who will enter them in the community online intelligence system for end users and managers system for managing intelligence production requirements.

MISO studies are unique in format; however, other military intelligence products can contain this type



A Soldier hands children MISO-produced posters as part of influence efforts in Afghanistan.

of intelligence information. In general, they profile the salient features of a country or its people; provide an analysis of the influences that lead different social, occupational, and ethnic groups of that country to act as they do; discuss issues that elicit strong responses from the indigenous population; assess attitudes; identify vulnerabilities; and suggest ways and means to influence people.

#### *4th and 8th Military Information Support Operations Groups*

The 4th and 8th MISGs organize, equip, and collectively train assigned and attached forces to rapidly deploy anywhere in the world and conduct MISO and other specified influence and communication tasks in any environment in support of combatant commanders and the interagency as directed by the President and the SecDef. Both MISGs are capable of conducting the following tasks:

- a. Deploy/redeploy and sustain all assigned and attached forces
- b. Execute tactical operations in support of rapid deployment forces, SOF, and other contingencies
- c. Organize and deploy operational level task-forces in support of JFCs

- d. Employ MIST to achieve SOF and GCC theater campaign plan objectives in conjunction with U.S. country teams and partner nations
- e. Execute multimedia development, production, distribution, and dissemination in support of all operations
- f. Operate a CONUS-based multimedia operations center as the digital and analog backbone of the global CT network
- g. Produce special studies, analyses, and assessments of foreign threat assessments in support of assigned units or as otherwise directed
- h. Execute civil authority information support

The 4th and 8th MISGs currently contain the following organizations:

- a. **CIE.** The group manages the CIE's strategic and operational analysis efforts necessary for mission planning. The CIE is organized into regionally focused cultural intelligence cells composed of civilian analysts holding advanced degrees and regional expertise. Analysts specialize in target regions and provide MISO-relevant information, strategic analysis, and advice during the planning and execution of missions. The CIE publishes and disseminates finished studies.



Sailors assist PSYOP soldiers in preparing leaflets for distribution.

- b. **Battalion.** The battalion is organized, trained, and equipped to provide supported commanders with planning, product development, production, and dissemination from operational to tactical levels. These battalions are regionally oriented and maintain a functional support relationship with their respective GCCs and TSOCs. The battalions support other regions as directed. The 8th MISG maintains one globally focused battalion.
- c. **Tactical Company.** A tactical company plans, integrates, and executes MISO in support of a JSOTF/SOTF. Each tactical company subordinated to a regional battalion is regionally aligned to support a SFG in executing a GCC's mission. However, the tactical companies subordinated to the globally focused battalion are not regionally aligned.

### *3rd Military Information Support Battalion*

The 3rd MISB provides regional and tactical MISO units with audio, visual, and audiovisual production support, product distribution support, signal support, electronic maintenance support, and media broadcast capabilities. The battalion provides production support to MISO forces from the media operations center (MOC) location at Fort Bragg, North Carolina, and through teams deployed with units around the world. The MOC is the media production and product archives hub for MISO and is critical to achieving the commanders' objectives.

### *MISO Operational Concept*

MISO forces can be tailored as planning and advisory teams (PAT) and as MIST to plan, synchronize, and execute influence activities in support of operational and strategic objectives.

### *MISO Planning and Advisory Team (MPAT)*

Each TSOC is the primary point of entry for ARSOF MISO in support of the GCC's TSCP and regional war plans. MPATs plan, integrate, and synchronize operational MISO for those plans.

### *Military Information Support Team (MIST)*

A MIST plans, integrates, and executes MISO to achieve military objectives in conjunction with other U.S. country team agencies and partner nation counterparts.

## 95th Civil Affairs Brigade (Airborne)

### Mission

The mission of civil affairs (CA) forces is to engage and influence the civil populace by planning, executing, and transitioning CAO in Army, joint, inter-agency, and multinational operations to support commanders in engaging the civil component of their operational environment, in order to enhance civil-military operations or other stated U.S. objectives before, during, or after other military operations. CAO are conducted by civil affairs forces, supported by other forces, to support the joint force commander's civil-military operations intent, and are synchronized with the supported commander's operational concept.



### Tasks

CA forces train to perform five core tasks.

#### Populace and Resources Control (PRC)

PRC seeks to assist HN governments or de facto authorities maintain control over their population centers. PRC includes measures that seek to identify, reduce, relocate or access population resources that may impede or otherwise threaten joint operation success.

Populace control measures include activities such as registration of the population, provision of identification cards or personal licenses, and establishment and operations of checkpoints.

Resources control measures can include animal and vehicle registration, specific controls on markets or food suppliers or producers, and controls on building materials. The intent is to support the HN in better controlling the resources potentially exploitable by destabilizing elements and ensure those resources are available to the population through legitimate institutions.

The CA element working in a special operations environment employs PRC measures to assist the legitimate HN and partnered forces in responding to civil vulnerabilities, thereby

meeting civil requirements, executing governance, creating influence, and maintaining or expanding legitimacy as part of a comprehensive strategy.

#### Foreign Humanitarian Assistance

Foreign humanitarian assistance programs are conducted in support of HN authorities or agencies to relieve or reduce the results of natural or man-made disasters or other endemic conditions that might present a serious threat to life or result in great damage to or loss of property. These activities can be quick impact and short term in nature or support a broader developmental strategy. Because these activities have the longest lasting influence on relevant populations, SOF CA elements must understand the supported command's desired effects and target projects to achieve specific results.

#### Nation Assistance

Nation assistance addresses a "by, with and through" approach in support of indigenous authorities to build capacity and capability for sustainable stability. FID, JCET events, and partner capacity-building programs serve as venues to assist partnered forces in creating increased capacity and capability in those forces, and expanding legitimacy and influence within the relevant populations.



95th Civil Affairs Brigade soldiers coordinate local security operations with indigenous officials and local villagers.

### *Support to Civil Administrations (SCA)*

SCA includes planning, coordinating, advising or assisting with those activities to reinforce or restore a civil administration. In a special operations environment, SCA also provides supported SOF commanders with the expertise to design activities to enable key leader engagement.

### *Civil Information Management (CIM)*

CIM is the process by which civil information is collected and fused with the supported JSOTF or TSOC commander to ensure timely availability of information for analysis and dissemination to military and nonmilitary partners. CIM is a critical element of the lethal and nonlethal targeting process; it ensures that critical information requirements within the civil domain are collected, analyzed, and shared with the broadest base of partners to ensure short, mid and long-term effects and objectives are both linked and achieved. Without the inclusion of civil information into the SOF and interagency targeting processes, only a part of the current operational picture is available for targeting and determining SOF program effectiveness.

### *Civil-Military Engagement (CME)*

While the CA core tasks endure across the range of military operations, in a special operations environment, they are conducted with the context of the SOF core activities (i.e., UW, FID, COIN, IO, etc.) and specific special operations CA mission activities (i.e., execution of CME).

- a. **Civil-Military Engagement** is the USSOCOM program of record for the deployment of CA forces to support TSOC objectives as part of U.S. Ambassador and USG strategic goals and objectives in specific countries and regions.
- b. **Civil-Military Support Elements (CMSEs)** are the units of action that conduct civil-military affairs. CMSEs are small, task-organized CA elements intended for persistent civil engagement in priority countries. These teams can be expanded as necessary to support episodic operations as part of TSOC theater campaign plans or U.S. Embassy plans. To ensure successful accomplishment of their mission, CMSEs go

through a unit-level pre-deployment train-up, tailored to both the specific mission objectives and situational context.

In the 21st century, CA's role has evolved towards a more proactive approach: establishing and maintaining positive relationships, building indigenous capacities and capabilities for a broad spectrum of governance tasks, identifying key influencers of public opinion to better influence support for indigenous governments, and conducting operations to generate support and legitimacy for USG-supported indigenous governments. All of these activities are part of broader USG efforts to foster indigenously sustainable stability through a comprehensive and population-centric approach to military operations.

“CA is the bridge between military forces and the civilian populace in a military operational area.”

—CJCSI 3110.12D, 15APR07



A 95th Civil Affairs Brigade soldier collects civil information from local children.

### *U.S. Army Civil Affairs Organization*

Until 2006, all Army civil affairs forces were designated as SOF and came under COCOM of USSOCOM. In November 2006, the RC CA units were transferred from USSOCOM to U.S. Army Reserve Command (USARC). Concurrent with this action, the RC CA forces were no longer considered SOF. However, USSOCOM retained proponentcy for all CA: This includes doctrinal development, combat development, and institutional training.

All CA units are capable of supporting both conventional forces and SOF at the tactical, operational, and

strategic levels. Since the transfer of RC CA to USARC, however, the non-SOF RC CA forces are more oriented toward supporting other conventional forces, and the SOF active component CA forces are oriented toward supporting other SOF.

While serving in an initial entry role during contingency operations, the 95th CA Brigade has the capability to rapidly deploy one of its regionally aligned CA battalions to meet an initial CA support requirement, and then transition that CA support requirement to an RC CA unit as soon as mobilization permits.

**95th Civil Affairs Brigade**

The 95th CA Brigade’s task is to rapidly deploy regionally focused, initial entry, civil affairs planning teams (CAPTs), civil-military operations centers (CMOCs), CA battalions, and CA companies to plan, enable, shape, and manage CA operations (CAO) in support of a GCC, TSOC, JFSOC, corps, division, or brigade combat team (BCT). The 95th CA Brigade can also serve as the core of a joint civil-military operations task force (JCMOTF). The brigade HQ provides command, control, and staff supervision of the operations of the CA brigade and assigned CA battalions or attached units. The 95th CA Brigade can support the GCC, the TSOC, the joint force land component commander, or the JFSOC. This HQ is rapidly deployable through various means of infiltration, to include static-line

parachute, providing USASOC with a responsive, flexible, and modular CA force package.

**Civil Affairs Battalions, 95th CA Brigade**

The CA battalions function as the tactical-level CA capability that supports the division, JSOTF, and forward operational bases. The battalions are regionally focused and support SOF while providing the rapid deployment “bridge” for the division and BCTs until replaced by U.S. Army Reserve CA battalions. The five CA battalions are:

- a. 91st Civil Affairs Battalion — USAFRICOM
- b. 92nd Civil Affairs Battalion — USEUCOM
- c. 96th Civil Affairs Battalion — USCENTCOM
- d. 97th Civil Affairs Battalion — USPACOM
- e. 98th Civil Affairs Battalion — USSOUTHCOM

The 95th CA Brigade, CA battalion rapidly deploys as the initial entry CA force with its CAPTs, CMOCs, CA companies, and Civil Affairs Teams (CATs) to plan, enable, shape, and conduct CAO to support the commander’s situational understanding of the civil component and improve overall decision superiority. The 95th CA Brigade, CA battalion has an HHC, a CAPT, a CMOC capable of providing a civil liaison team (CLT), and four CA line companies, each with a CMOC. Each CA line company can provide C2 to the assigned CATs

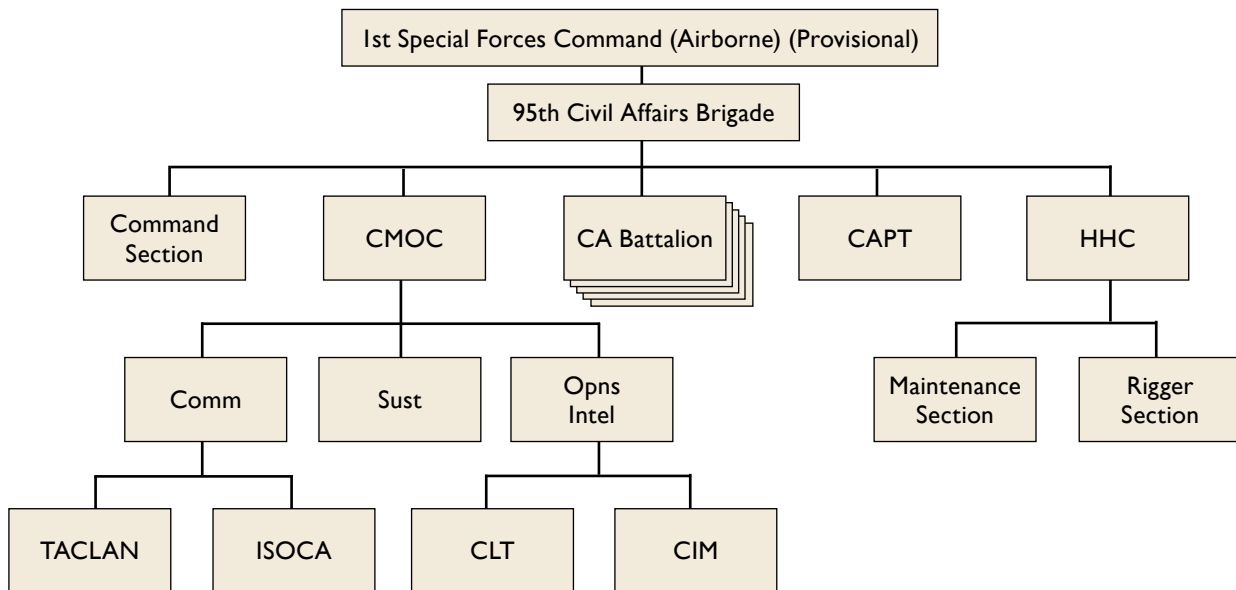

Figure 3-10. 95th Civil Affairs Brigade Organization

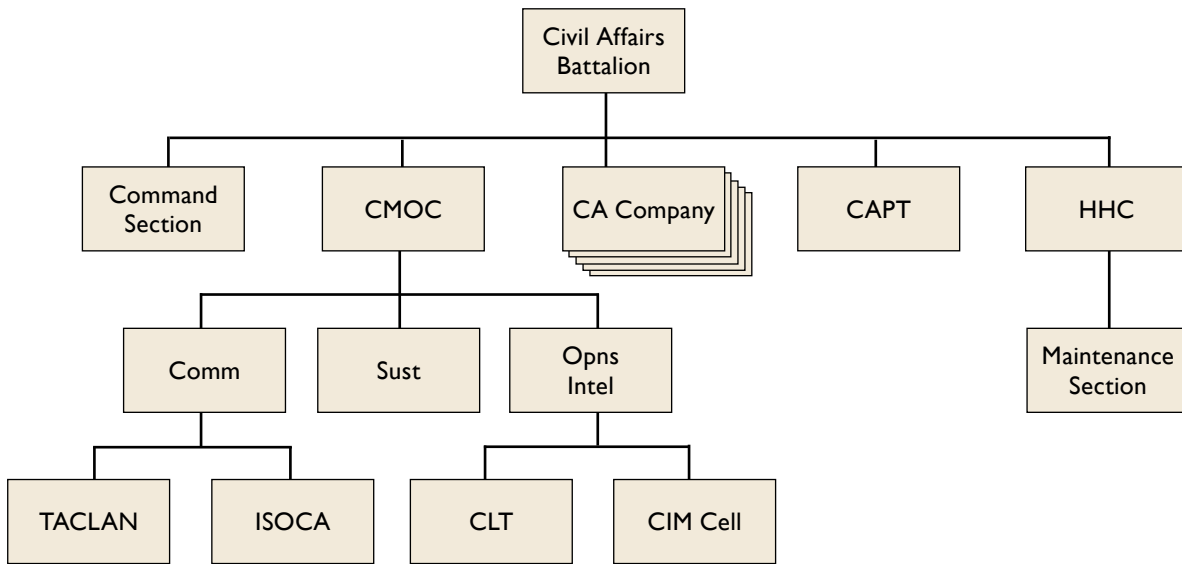

Figure 3-11. Civil Affairs Battalion Organization

and can provide planning, coordination, and assessment at the tactical level.

Each CA Battalion includes five CA Companies, each of which includes four CATs and a CMOC, so that each battalion provides 20 CATs and five CMOCs.

**Civil Affairs Company**

The CA battalion has six CA line companies, each with a C2 Section, a CMOC, and five civil affairs teams (CATs). The CMOC provides tactical CA support, to include assessment, planning, and coordination. The CA company assesses the mission planning requirements and develops and coordinates the resources to meet immediate requirements to mitigate civil threats to the supported commander’s mission.

**Civil Affairs Team (CAT)**

The CAT conducts CAO and provides CMO planning and assessment support to tactical maneuver commanders. The CAT conducts civil reconnaissance (CR); conducts key leader engagement by constantly vetting contacts to eventually identify elites within the CAT’s AOR; plans, coordinates, and enables CAO and project management; and provides civil information to the supported unit and CMOC for inclusion of civil inputs to the supported commander’s common operational picture (COP).

A CAT is composed of four personnel: the team chief, team sergeant, and two civil affairs NCOs.

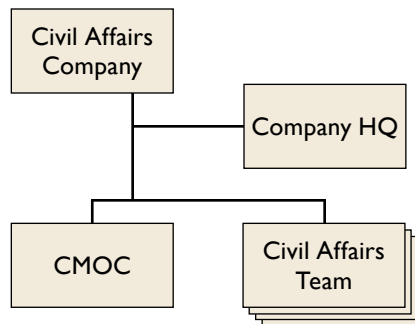

Figure 3-12. 95th CA Brigade CA Company

## 528th Sustainment Brigade (Special Operations) (Airborne) - SB(SO)(A)

The 528 SB(SO)(A), is a Table of Organization and Equipment (TOE)-deployable organization assigned to USASOC, and task-organized under 1st SFC (A) (P). The Brigade provides Army SOF with:



- a. Expeditionary communications support
- b. Limited, short-term, and expeditionary role II (care provided at a division or corps clearing station) medical support
- c. Logistics plans, synchronization, and coordination support

The 528 SB(SO)(A) is unique among sustainment brigades in that the 528 SB(SO)(A):

- a. Maintains global situational awareness of deployed ARSOF logistics support structures
- b. Is multi-composition in structure
- c. Is focused at the operational level for logistics planning and synchronization
- d. Deploys as small, modular teams
- e. Trains, resources and equips the Army's only special operations signal battalion (112th Signal Battalion)
- f. Contains three expeditionary medical-role-II teams to enable ARSOF units to operate with conventional forward surgical teams or other resuscitative surgical teams

### Mission

**Core Mission.** The 528 SB(SO)(A) sets the operational-level logistics conditions in order to enable ARSOF operations.

### Mission Essential Tasks

- a. Coordinate ARSOF logistics requirements, plans, Army-common logistics, and sustainment in six GCC AORs to support deployed ARSOF and joint/combined SOF where the Army is the executive agent. ARSOF liaison elements (ALEs) accomplish this by working with both the TSOC and ASCC to ensure ARSOF

logistics requirements generated by TSOC plans, exercises and operations are integrated into the ASCC concept of support for the theater.

- b. Deploy operational level logistics synchronization capabilities in support of ARSOF-led JSOTFs and SOTFs. The 528 SB(SO)(A) deploys ARSOF support operations (ASPO) cells to collocate with theater support commands (TSCs) and expeditionary sustainment commands (ESCs) to ensure deployed ARSOF to synchronize ASCC provided logistics support and SOF-peculiar logistics support to ARSOF units.
- c. Provide expeditionary, limited and short-term medical-role-II capabilities to deployed ARSOF. Role II medical teams assigned to the brigade headquarters and headquarters company (HHC) allow deployed ARSOF to integrate resuscitative surgical teams in support of ARSOF operations.
- d. Train, resource, and equip the 112th Signal Battalion.
- e. Deploy a tailored brigade headquarters to C2 operational-level logistics in support of ARSOF operations until relieved by ASCC logistics C2 capabilities. The 528 SB(SO)(A) is capable of providing C2 of Army combat sustainment support battalions (CSSBs) operating in support of ARSOF for up to six months.

### Concept of Employment

The 528 SB(SO)(A) ALEs are permanently employed in their specific region by being stationed with or in close proximity to each TSOC.

During ARSOF initial-entry operations into a theater, the ALE locates where it can best ensure plans and requirements developed at the TSOC are incorporated into the ASCC's logistical planning. During initial-entry operations, the SB(SO)(A) Operations Division reinforces ALE planning efforts from its home station operations center (HSOC) at Fort Bragg. The Operations Division may also reinforce ALE efforts in the region by locating Operations Division personnel forward with the ALE when required.

As the theater matures and conventional theater support units arrive, the 528 SB(SO)(A) may deploy ASPO cells into the joint operational area in support of an ARSOF-based JSOTF or a SOF-based JTF. ASPOs

may co-locate with the TSC/ESC, CJOSTF headquarters, group support battalion (GSB), or Ranger support operations detachment (RSOD) where they will synchronize ASCC provided logistics support to ARSOF units.

During theater expansion, the 528 SB(SO)(A) may be directed to deploy a tailored brigade headquarters to C2 operational-level logistics in support of ARSOF operations, until relieved by ASCC logistics C2 capabilities.

Not resourced to operate as a stand-alone headquarters due to the lack of base-operations mission-capable support personnel, the 528 SB(SO)(A) requires augmentation or activation of its reserve-component

companies to perform this mission. The organization can conduct 24-hour operations as a logistics integrator for SOF sustainment requirements.

The 528 SB(SO)(A) will deploy with organic personnel and equipment but may also embed logistic planners within supported unit staff cells or theater support staffs. Initially, the 528 SB(SO)(A) may be OPCON to the TSC to establish the unity of command required to achieve the JFC's campaign objectives.

If conventional forces are required in-theater, the TSC deploys its ESC into the theater of operations to establish

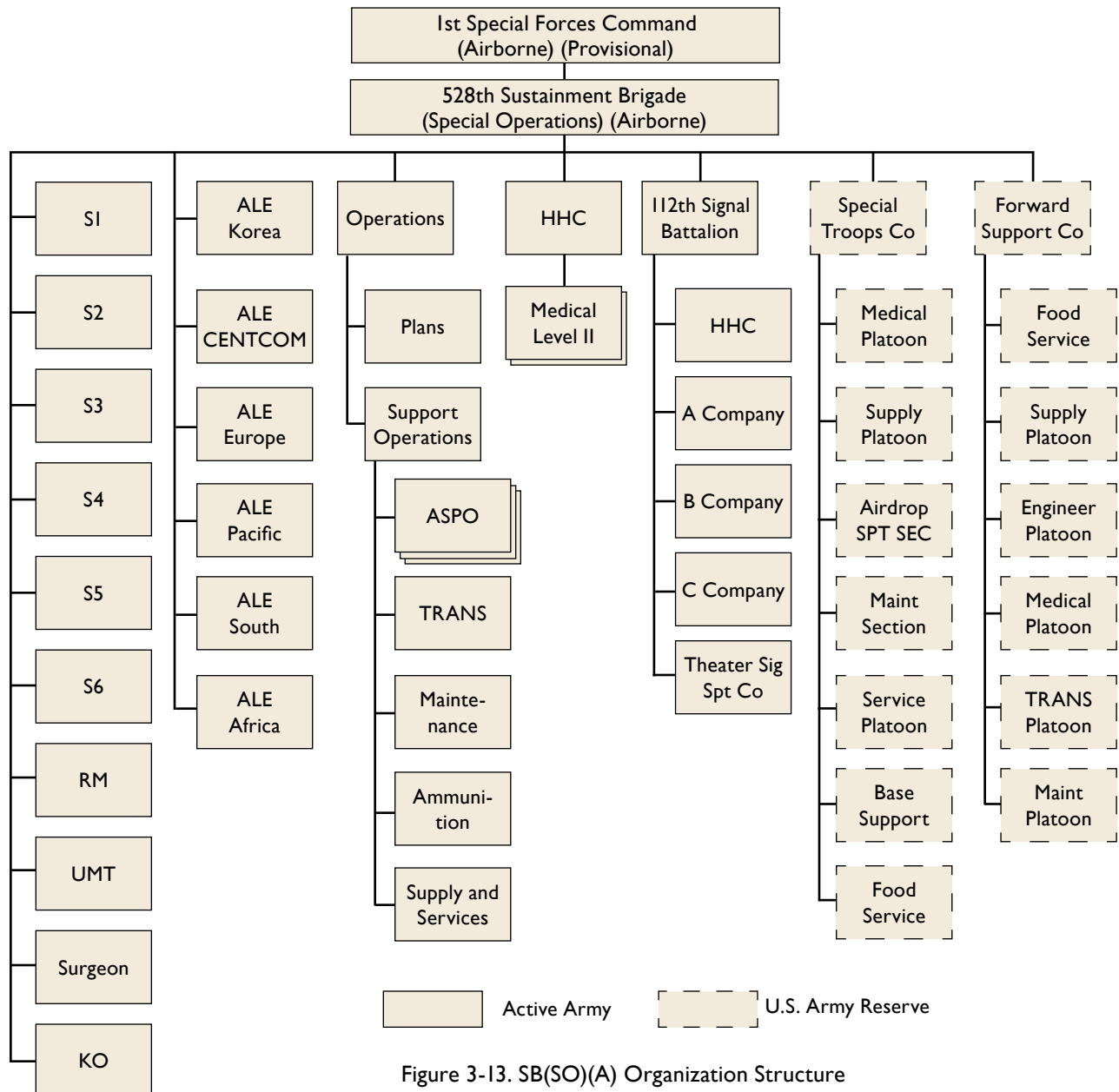

Figure 3-13. SB(SO)(A) Organization Structure



C2 of logistic operations, theater opening functions, and relieves the 528 SB(SO)(A) (if deployed). The TSC establishes C2 of logistic operations in the theater and functions as the single operator for theater distribution; synchronizing the flow of forces and logistics in accordance with the JFC's campaign plan and intent. When an ESC is deployed, the 528 SB(SO)(A) will deploy an ASPO to collocate with the ESC to synchronize ASCC provided logistics support to ARSOF units.

### *Capabilities*

The 528 SB(SO)(A) provides command and control to HHC, SB(SO)(A); the Special Troop Company (A), Army National Guard (ARNG); a Forward Support Company (A) (ARNG); and the 112th Signal Battalion (SO)(A). The 528 SB (SO)(A):

- a. Provides expeditionary communications support; limited, short-term and expeditionary role II medical support; and logistics plans, synchronization and coordination support to ARSOF.
- b. Deploys rapidly and task-organizes as required to provide C2 of logistics, Army health support, and communications support to ARSOF.
- c. Provides ALE support to TSOCs in order to conduct detailed logistics planning in support of ARSOF operations. ALE planning capabilities include maintaining a theater Army logistics estimate, identifying SOF logistics requirements, coordinating for resources to enable operational requirements, assist the TSOC in the development of a concept of support and coordinating, through the 528 SB(SO)(A) HSOC, for SOF-peculiar and Title 10 support for ARSOF units.
- d. Will be prepared to provide C2 for two CSSBs in support of a JTF or JSOTF for up to six months.
- e. The 528 SB(SO)(A) HQ ensures deployed ARSOF CSS requirements are met by the ASCC, theater, HN, joint, and third-country logistics infrastructures.
- f. In accordance with proper mobilization standards, mobilizes ARNG soldiers and equipment from the Special Troop Company (Airborne) (STC-A) and Forward Support Company (FSC) to execute the 528 SB(SO)(A) mission. When employed in support of the 528 SB(SO)(A), the

ARNG soldiers provide the base operating support capabilities for the 528 SB(SO)(A), such as engineering, base operations, food service and field feeding, communications, maintenance, unit maintenance team (UMT), staff augmentation for personnel, and communications. The ARNG FSC is designed to execute tactical-level logistics operations as directed by the SB(SO)(A).

## U.S. Army John F. Kennedy Special Warfare Center and School

The United States Army John F. Kennedy Special Warfare Center and School (USAJFKSWCS) provides the training, personnel, doctrine, and policy to support ARSOF. USAJFKSWCS serves as the USASOC proponent for all matters pertaining to individual training, develops doctrine and all related individual and collective training material, provides leader development, develops and maintains the proponent training programs and systems, and provides entry-level and advanced individual training and education for SF, CA, and MISO.

### Task

USAJFKSWCS recruits, trains, and educates U.S. Army SF, PSYOP, and CA soldiers. USAJFKSWCS provides training in advanced skills as required. It supports ARSOF's ability to conduct operations worldwide, across the USSOCOM core functions, by providing superior training, relevant doctrine, effective career management policy, and the highest quality soldiers to man the Army's premier special operations fighting forces.

### Organization

USAJFKSWCS is a direct reporting unit to USASOC, and has a close working relationship with U.S. Army TRADOC as the Special Operations Center of Excellence. SWCS also works closely with the special operations recruiting battalion (SORB) which is responsible for recruiting soldiers from within the Army for the CA, PSYOP and SF regiments. SWCS is composed of the headquarters; the center, which consists of one directorate; and the school, which consists of five training units.

### 1st Special Warfare Training Group (Airborne) - SWTG(A)

The 1st Special Warfare Training Group (Airborne), SWTG(A) develops U.S. Army SF, CA, and PSYOP soldiers by providing superior entry-level through advanced training and education. The SWTG serves as the center of gravity for SOF institutional training, ensuring that the special operators with the best capabilities available to produce a full-spectrum special operations force prepared to work independently or as part of a combined, joint, interagency effort through or with indigenous partner forces to address the diverse range of threats posed by an uncertain 21st-century environment.

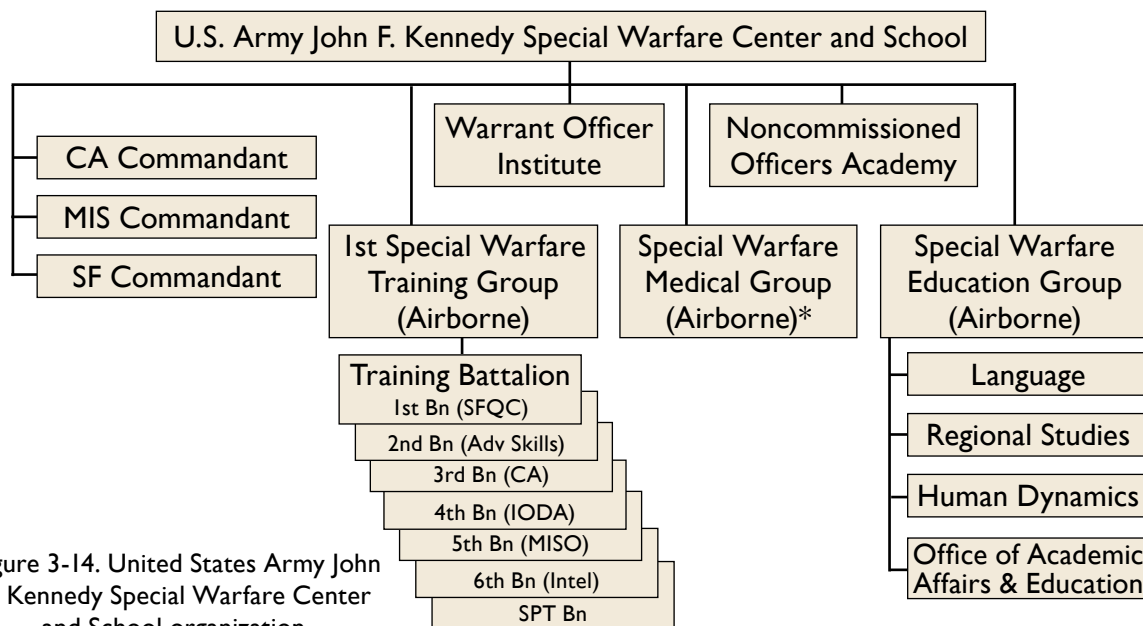

Figure 3-14. United States Army John F. Kennedy Special Warfare Center and School organization.

\* SWMG, in association with the Naval Special Operations Medical Institute (NSOMI), compose the Joint Special Operations Medical Training Center (JSOMTC).

The SWTG is made up of six training battalions and one support battalion. The 1st Battalion trains entry-level Special Forces soldiers to succeed in combat on a SFOD-A. The 2nd Battalion trains SOF and other selected personnel in advanced special-operations skills, TTPs in CONUS, implements and evaluates associated doctrine, then deploys military training teams worldwide in support of regional combatant commanders and DOD missions. The 3rd Battalion trains and educates Army officers, NCOs and advanced individual training soldiers in CAO. Utilizing the Instructor ODAs (IODAs) and ODBs 4th Battalion trains, advises, manages, counsels, and provides mentorship to all assigned students (U.S. and foreign) in the Special Forces Qualification Course (SFQC) in order to produce expertly trained and well-prepared Special Forces soldiers. The 5th Battalion trains and educates Army officers, NCOs and advanced individual training soldiers in military information support. The 6th Battalion trains and educates Green Berets, joint special operations forces and other selected interagency personnel to conduct specialized intelligence and operational activities in order to provide them an unmatched capability to understand and address the diverse threats of the 21st century. The support battalion sustains the training force through the forecast and management of eight fundamental commodities consisting of communication and electronic, armament, aerial delivery, transportation, food service, publications, facilities.

#### ***Special Warfare Education Group (Airborne)- SWEG(A)***

SWEG(A) is located in Bank Hall at Fort Bragg and is responsible for assessing, selecting, and educating U.S. Army CA, MISO, and SF soldiers and civilians throughout their careers by providing relevant instruction and professional development in order to possess the capability to succeed in any global region. SWEG(A) is divided into a Headquarters Company and four departments: Academic Affairs and Education, Human Dynamics, Regional Studies, and Language.

The Academic Affairs and Education Department supports ARSOF in attaining their associate, bachelor's, master's or doctoral degrees. The department also provides instructor training and certification through the Special Operations Instructors Courses as well as conducting PME programs through the Captain's

Career Course and the Pre-Command Course. Contact an education counselor for additional information.

The Human Dynamics Department conducts the Army Special Operation Forces Assessment and Selection and Screening Course Programs in Civil Affairs, Military Information Support Operations, Special Forces, and Cultural Support. Human Dynamics also supports learning and performance enhancement through the Special Operations Center for Enhanced Performance (SOCEP); through Tactical Human Optimization, Rapid Rehabilitation, and Reconditioning; and through adaptive thinking and leadership courses and training enhancement.

The Regional Studies Department offers both a foundational introduction to the systems approach to regional analysis and cultural competencies and an intermediate course that covers country-focused cross-cultural communications in a regional and global context. These regional study courses are taught within the language courses, as part of the Qualification courses, and in support of the Culture Support Training course.

The Language Department provides basic language instruction for all the Special Operations Qualification Courses in 13 core languages (Spanish, French, Indonesian, Thai, Tagalog, Korean, Chinese, Russian, Dari, Pashto, Arabic, Persian-Farsi, and Urdu). This course is 24 weeks long and designed to give the student a basic speaking and listening proficiency level on the Oral Proficiency Interview (OPI). The Language Department also offers an Intermediate Level Course of instruction in seven of the core languages which is designed to bring the student to the next level of proficiency on the OPI and the Defense Language Proficiency Test. The Language Department also provides language sustainment and enhancement programs throughout the careers of ARSOF soldiers.

#### ***Special Warfare Medical Group (Airborne)-SWMG(A)***

The SWMG(A), in association with the Naval Special Operations Medical Institute, compose the Joint Special Operations Medical Training Center (JSOMTC). The JSOMTC educates and trains the full spectrum of USSOCOM combat medics through superior teaching and instruction based on educational goals and curriculum development that is synchronized with the requirements of the force. The JSOMTC creates

well-educated and professionally trained SOF combat medics with a solid understanding of the knowledge and skills required by the force to provide standard of care medical treatment, regardless of the conditions. This ensures they have a thorough foundation in medicine which fosters a career of life-long learning in order to adapt to ever-changing medical challenges posed by an uncertain operational environment.

#### ***Special Forces Warrant Officer Institute***

The Special Forces Warrant Officer Institute is an adaptive and collaborative learning institution that provides the most current and relevant PME for Special Forces warrant officers at every level of their career in support of operational requirements. The Special Forces Warrant Officer Institute supports all of the lifelong learning requirements of both warrant officer candidates and senior warrant officers in the 180A MOS. The institute educates, mentors, trains and appoints warrant-officer candidates to the grade of WO1 as well as provides education and training to senior warrant officers at key points in their career. The institute produces highly capable combat leaders and innovative planners capable of planning and executing SF missions.

#### ***“David K. Thuma” Noncommissioned Officer Academy***

The NCO Academy serves as the United States Army John F. Kennedy Special Warfare Center and School’s premier generating force for implementing and assisting with design and development for the Warrior Leader, Advanced and Senior Leader courses, ensuring the highest quality of training, education and professional development for all special-operations NCOs.

#### ***Capabilities Development and Integration Directorate***

The Capabilities Development and Integration Directorate, (CDID), is a relatively new organization at the SWCS. Formed as a result of the 2011 optimization, the CDID is a hybrid organization that deals with doctrine, personnel proponency and the future training, leadership, and education needs of the Army SOF. It is composed of the former Directorate of Training and Doctrine, Directorate of Special Operations Proponency, and the Army Special Operations Capability Integration Center. Currently, in the CDID there are three branch proponents: CA, MISO, and SF; and for ARSOF over-arching requirements there are three

major elements: Personnel Policies and Programs; Training, Leader Development, and Education (TLDE); and the Army Special Operations Capabilities Integration Center (ARSOCIC).

#### ***Branch Commandants (CA, PSYOP, & SF)***

The new Branch Proponent Commandants were built using as a base the former DOTD doctrine divisions and the integration of the branch sections from the former Training Development Division and from the Directorate of Personnel Proponency. Each commandant is responsible for its branch’s force modernization, which consists of personnel, doctrine and training development. Each of the commandants also conducts analysis, design, development and internal evaluation for CA, PSYOP, and SF officer and enlisted institutional individual training and education in support of SWCS’s proponent responsibilities.

#### ***Personnel Policies and Programs Center***

Personnel Policies and Programs supports ARSOF by providing strategic guidance, direction, recommendations and products involving ARSOF personnel, manpower and other overarching lifelong personnel management programs.

#### ***Training, Leader Development, and Education***

Training, Leader Development, and Education (TLDE) has three major functions: ARSOF common PME support across the life-long learning model for officers, warrant officers and noncommissioned officers; Training Capabilities Management (TCM), which is focused on distributive learning, computer-based instruction and the virtual mission rehearsal tool suites; and Training Management Office (TMO).

#### ***Army Special Operations Capabilities Integration Center (ARSOCIC)***

The mission of the Army Special Operations Capabilities Integration Center (ARSOCIC) is to conduct future ARSOF requirements and capabilities analysis, concept development, experimentation and wargames and Joint/Army Doctrine Integration and development. The ARSOCIC is composed of three functional divisions: ARSOF Future Capabilities Division, Concept Development and Experimentation Division and Joint/Army Doctrine Integration Division.

## 75th Ranger Regiment

General Odierno's charter to the 75th Ranger Regiment identifies the Regiment as the most elite infantry force in the world and the Army's premier special operations raid force. Since 2006, the 75th Ranger Regiment's command structure has consisted of three Ranger battalions, a regimental special troops battalion, and a regimental headquarters. Elements of the Ranger Regiment have been continuously deployed in support of contingency operations in multiple theaters since October 2001.



Army Rangers conduct a parachute drop.

### 75th Ranger Regiment Missions

The 75th Ranger Regiment plans and conducts joint special military operations in support of U.S. policy and objectives. Its primary mission is to conduct forcible entry operations in hostile or sensitive environments worldwide. Its secondary mission is to conduct special operations raids on key targets of operational or strategic importance to capture high value individuals, destroy enemy nodes or facilities, or recover

designated personnel or equipment. Its tertiary mission is to conduct platoon to regiment sized offensive infantry operations.

A typical Ranger mission may involve seizing an airfield from which to launch raids on high value targets, or extract isolated personnel or other precious cargo out of the area of operation. Once secured, follow-on conventional airland or airborne forces may be introduced into theater to relieve the Ranger forces so that it may conduct future SOF operations.

### 75th Ranger Regiment Organization

The 75th Ranger Regiment, headquartered at Fort Benning, Georgia, is composed of four Ranger battalions, and is the premier light-infantry unit of the United States Army. The Regiment's four Ranger battalions are geographically dispersed. Their locations are:

- a. 1st Battalion, 75th Ranger Regiment, Hunter Army Airfield, Georgia
- b. 2nd Battalion, 75th Ranger Regiment, Joint Base Lewis-McChord, Washington.
- c. 3rd Battalion, 75th Ranger Regiment, Fort Benning, Georgia
- d. 75th Regimental Special Troops Battalion, 75th Ranger Regiment, Fort Benning, Georgia

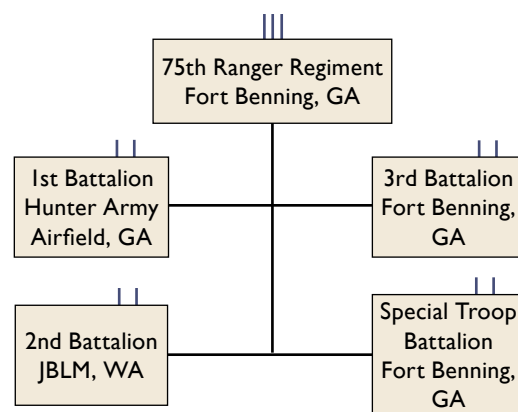

Figure 3-15. 75th Ranger Regiment Organization

### Regimental Headquarters

The headquarters consists of the command group, normal staff positions S-1 through S-6 and S-8, a fire support element, special staff, a medical section, and a company headquarters. Additionally, the Regiment has the capability of deploying a planning team consisting of experienced Ranger operations, intelligence, fire support, communications, and logistics planners. The planning team can deploy on short notice, with USASOC approval, to TSOCs to plan Ranger operations during crisis action planning for contingency operations.

### 75th Regimental Special Troops Battalion (RSTB)

The RSTB consists of a reconnaissance company, a communications company, an intelligence company, and an operations company. Assets within the special troops battalion can deploy in support of individual Ranger battalions or as a whole to support Regimental operations.

### Ranger Rifle Battalions

There are three identical Ranger rifle battalions subordinate to the 75th Ranger Regiment. Each rifle battalion is composed of a headquarters and headquarters company (HHC), four rifle companies, and a support company.

**Battalion HHC.** The battalion HHC also has a sniper platoon, mortar platoon, reconnaissance platoon, medical

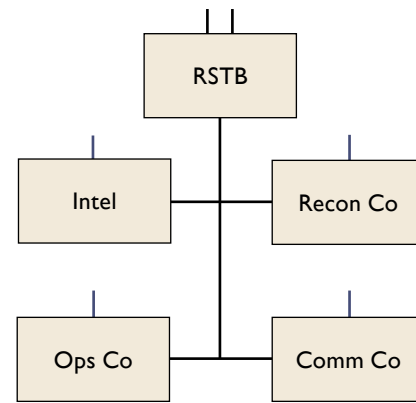

Figure 3-16. Regimental Special Troops Battalion Organization

section, communications section, K9 (dog) section, and a tactical surveillance equipment section.

The sniper platoon is organized into a headquarters section and two sections of six 2-man sniper teams each. These snipers are highly proficient marksmen trained to employ the M24 sniper weapon system, Barrett .50 caliber rifle, and the SR25 sniper rifle, all of which are night-capable.

The battalion mortar platoon is organized into a headquarters section, a fire direction control section, and two sections of two mortar squads each. The platoon has the 60-mm, 81-mm, and 120-mm mortar systems. Mortars are issued and employed based upon mission, enemy, terrain and weather, troops and support available, time available, and civil (METT-TC) considerations. The mortar platoon is able to operate split-section or at platoon level.

**Support Company.** Each Ranger battalion has a Ranger support company (E Company) that provides distribution, maintenance, and sustainment capabilities for all classes of supply. This element provides the battalion the ability to operate independently for prolonged periods of time and integrate with supporting command logistic units. This support element is also capable of independently out-loading the battalion and conducting reception, staging, onward movement, and integration upon arrival at a designated location.



U.S. Army Rangers assigned to 2nd Battalion, 75th Ranger Regiment, prepare to assault their objective during Task Force Training on Camp Roberts, California, 31 January 2014.

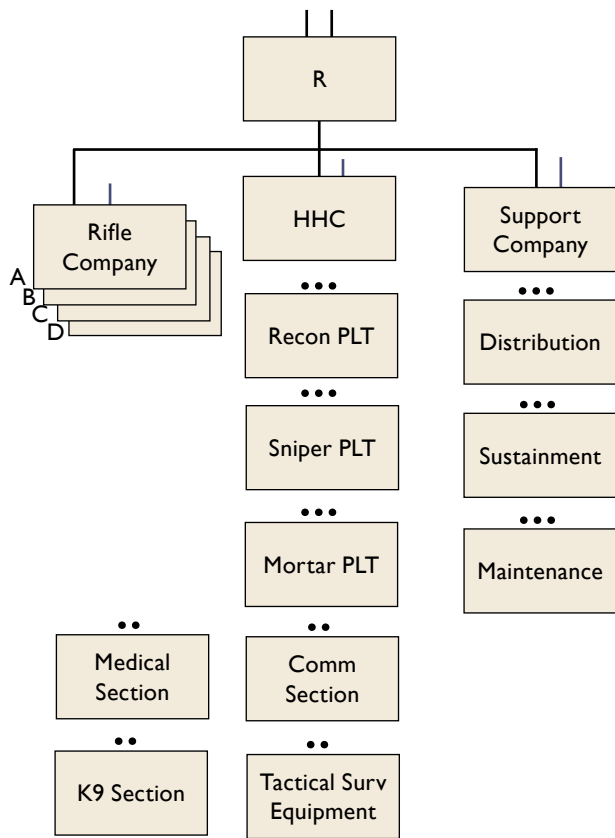

Figure 3-17. Ranger Rifle Battalion Organization

**Ranger Rifle Companies.** There are four rifle companies in each Ranger battalion and the companies are identically organized.

- a. The company antitank section is organized into three two-man antitank teams. Their primary weapons are the 84-mm Carl Gustav Ranger Anti-Armor Weapons System (RAAWS) and the Javelin Antitank Missile.
- b. The fire support element (FSE) consists of an artillery forward observer (MOS 13F) and a radiotelephone operator per platoon.
- c. The company headquarters has an artillery fire support officer, fire support NCO and fire support specialist.
- d. The medical section consists of one medical NCO (MOS 68W) per company and two medics per platoon.
- e. Each rifle platoon has three seven-man squads and a machine gun squad with three 2-man machine gun teams.

**Equipment**

Each Ranger rifle company has eight ground mobility vehicles—desert-equipped High Mobility Multipurpose Wheeled Vehicles. The support companies have a fleet of 5-ton vehicles, two fuelers, recovery vehicles, and maintenance vehicles. Normally, each vehicle mounts an M240G machine gun and either an MK-4 grenade launcher or a M2, .50 caliber machine gun. One of the passengers mans an antiarmor weapon (RAAWS, AT-4, LAW, and Javelin). The Ranger Special Operations Vehicle’s main purpose is to provide a mobile, lethal, defensive capability. They are not assault vehicles, but are useful in establishing battle positions that provide the force some standoff capability for a short duration. Each battalion also possesses 10 all-terrain vehicles (ATVs) and eight 80cc minibikes that assist in providing security and mobility during airfield seizures. Most commonly used as runway clearing assets, listening posts/observation posts, or as an economy of force screen for early warning, the ATVs and minibikes offer the commander tactical mobility.

**Command and Control**

The flexibility of the Ranger force allows it to perform under various command structures. The force can work unilaterally under a corps, as a part of a JSOTF, as a SOTF, or as an Army component in a JTF. Historically,

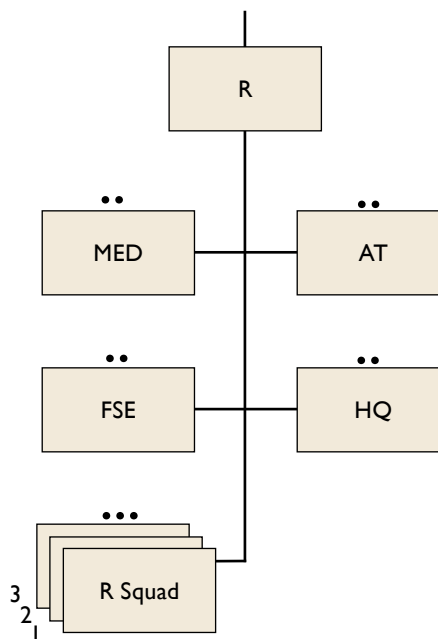

Figure 3-18. Ranger Rifle Company Organization



An Army Ranger prepares to enter and clear a room on an objective in Afghanistan.

it is common for the Ranger force to conduct forced entry operations as part of a JSOTF, and then become OPCON to a JTF to afford them the capability to conduct special operations/direct action missions.

### Capabilities

Ranger DA operations are short duration strikes or other small scale operations to seize, destroy, or capture enemy forces or facilities, or to recover designated personnel (noncombatant evacuation operations, liberate friendly prisoners of war, capture designated enemy personnel) or equipment in hostile, denied or politically sensitive areas. These operations are conducted independently or in support of a campaign plan and often have strategic implications. They may be conducted in coordination with conventional forces, but differ from conventional operations in degree of risk, operational techniques, and modes of employment. They rely on undetected insertion and rapid movement to the target if the force is inserted offset from the objective and surprise and shock if the insertion is on the target. Rangers normally operate under conditions of air superiority.

The strategic responsiveness of the Ranger force provides the President and/or the SecDef a credible combat capability for protecting selected vital U.S. interests without having to wait for international support

or guarantees of non-intervention. The Ranger force is frequently the primary element of ground combat power when the U.S. conducts a forcible entry operation.

During short duration operations, Ranger units require minimal support and are not designed for sustained independent operations beyond approximately five days of continuous combat.

For longer duration combat operations Ranger units have their own organic support companies capable of integrating with theater support assets to provide logistic support across all classes of supply. During all phases of operations and training, Ranger units require responsive and adequate support, either from theater Army or SOF assets.

### Limitations

Ranger units have a limited anti-armor capability (84mm Carl Gustav and Javelin) and organic indirect fire support assets that include 60-mm, 81-mm, and 120-mm mortars. The only air defense artillery system is the Stinger. Ranger units have limited organic ground mobility assets.

### Deployment

The 75th Ranger Regiment maintains a high level of unit readiness. The Regiment can deploy one Ranger battalion and a Regimental C2 element within 18 hours of alert notification. It can follow with two additional battalions within 72 hours. The Regimental Headquarters maintains command and control and liaison elements, along with communications, reconnaissance, and intelligence teams from the special troops battalion immediately available for deployment. Higher levels of readiness status can be achieved in response to specific world situations. Deployment options include:

- a. Deploying directly from home station to the target area
- b. Deploying from home station to a CONUS or OCONUS intermediate staging base (ISB) with logistical unit support, then deploying to the target area or to a forward staging base (FSB) from the ISB



c. Deploying from home station to a seaport of embarkation to board a naval vessel, such as an aircraft carrier or other suitable vessel, which serves as an afloat forward staging base. The vessel transports the Ranger force, along with

special operations helicopters, and conducts air assault operations into the target area. Additionally, a Ranger force can link up with an afloat forward staging base underway via helicopter from a land-based ISB or forward staging base.



Rangers from 1st Battalion, 75th Ranger Regiment conduct Fast Rope Insertion Extraction System training from an MH-47.

## U.S. Army Special Operations Aviation Command (USASOAC)

The United States Army Special Operations Aviation Command (USASOAC) provides command and control, executive oversight, and resourcing of USASOC aviation assets and units in support of national security objectives. USASOAC is responsible for service and component interface; training, doctrine, and proponency for Army SOA; system integration and fleet modernization; aviation resource management; material readiness; program management; and ASCC oversight. USASOAC was established in March 2011.

### USASOC Flight Company (UFC)

The UFC was activated in June 2013 by USASOAC and provides responsive fixed and rotary wing training support to USASOC, as well as key planner transport in support of contingency plans. The company was a detachment that began its unique mission in 1996. Its aircraft inventory includes UH-60L Blackhawk helicopters, and CASA-212, C-27J, and C-12C fixed-wing airframes.

### 160th Special Operations Aviation Regiment (Airborne) - 160th SOAR(A)

The Army owes its modern night fighting aviation capabilities to the 160th Special Operations Aviation Regiment (Airborne). The 160th SOAR(A) pioneered night flight techniques, shared in the development of equipment, and proved that *Night Stalkers Don't Quit*—the motto the regiment lives by. The unit began in the summer of 1980 as Task Force 158 with elements of the 158th Aviation Battalion, 101st Aviation Battalion, 229th Aviation Battalion and the 159th Aviation Battalion. Aviators and support personnel immediately entered into a period of intensive night flying and quickly became the Army's premier night fighting aviation force. The

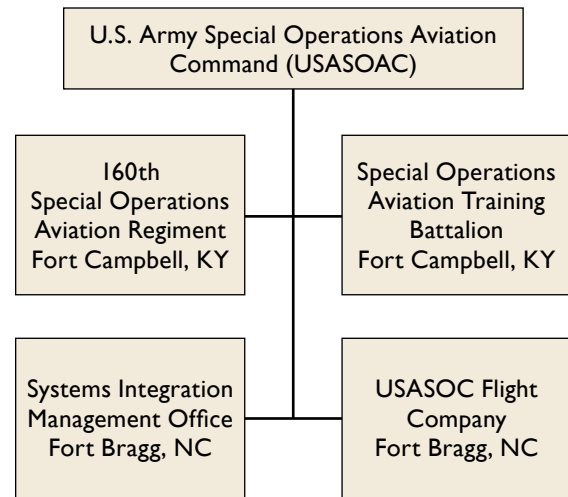

Figure 3-19. USASOAC Organization Chart

160th Aviation Battalion was activated as a unit of the 101st Airborne Division (Air Assault) on 16 October 1981 and, with the same attachments that formed its predecessor unit, became Task Force 160. Since its formation, the 160th has become known as the Night Stalkers because of its capability to strike undetected during darkness. Over the years, the unit has grown to regimental size and has greatly increased its mission capabilities. It routinely provides precision rotary wing aviation support to joint SOF around the world.

### SOAR Mission

The 160th SOAR(A) mission is to organize, equip, train, resource, and employ Army Special Operations Aviation forces worldwide in support of the contingency and crisis action missions of the warfighting commanders.

### SOAR Organization

The regiment consists of a headquarters and headquarters company (HHC) and four special operations aviation battalions. Additionally, Table of Distribution and Allowance (TDA) documents authorize a special operations aviation training company (SOATC) and a systems integration and maintenance office (SIMO).

## Responsibilities in Support of SOF CORE Activities

The SOAR supports all special operations core activities. It operates predominantly in a joint environment and may support U.S. military conventional forces, multinational forces, or other agencies in addition to joint SOF. The following summarize the SOAR's execution and support of core activities:

- a. Infiltrate, sustain, and exfiltrate U.S. SOF and other selected personnel
- b. Insert and extract SOF land and maritime assault vehicles and vessels
- c. Conduct DA and close air support (CAS) using organic attack helicopters to provide aerial firepower and terminal guidance for precision munitions, unilaterally or with other SOF
- d. Conduct SR missions in support of SOF
- e. Conduct electronic, photographic, and visual reconnaissance in support of SOF
- f. Recover personnel or sensitive materiel in concert with SOF
- g. Conduct combat search and rescue (CSAR) as a part of the SOF component apportioned to the joint personnel recovery center when the mission requires capabilities above and beyond conventional theater CSAR assets
- h. Conduct assisted evasion and recovery in lieu of dedicated CSAR assets
- i. Perform emergency air evacuation of SOF during the conduct of special operations
- j. Conduct limited strategic self-deployment of aerial refuel-capable helicopters
- k. Support joint special operations maritime operations

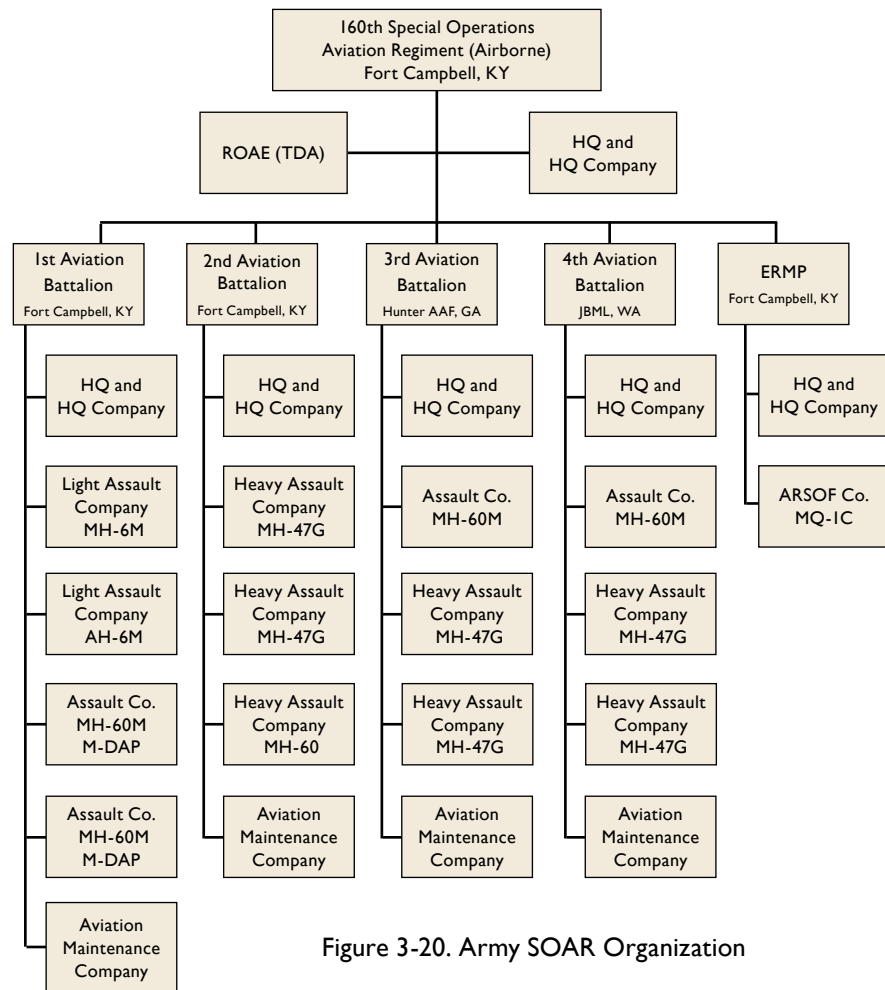

Figure 3-20. Army SOAR Organization

- l. Conduct special operations water insertion and recovery operations
- m. Support and facilitate ground and aerial C2, communication and computer systems, and reconnaissance and intelligence operations for SOF
- n. Provide the C2 element for special operations aviation assets and attached conventional aviation assets supporting special operations
- o. Perform aviation unit maintenance and aviation intermediate maintenance for all organic aircraft

## SOAR Aircraft and Employment Considerations

The regiment possesses three main types of rotary-wing aircraft: the AH/MH-6M Little Bird, the MH-60M, DAP Blackhawk, and the MH-47G Chinook. This variety of aircraft allows for operations in all environments and under adverse weather conditions.

The SOAR normally task-organizes around a battalion and plans, conducts, and supports special operations missions for the ARSOF commander or for the TSOC. With proper personnel and equipment augmentation, a SOAR commander and his staff can serve as a joint special operations air component commander (JSOACC).



MH-6

#### *AH/MH-6M*

The AH and MH-6M are highly modified single-engine light helicopters. The MH-6 can externally transport up to six combat troops and their equipment and is capable of conducting overt and clandestine infiltration, exfiltration, and combat assaults over a wide variety of terrain and environmental conditions. The AH-6 can be armed with a variety of weapons and is primarily employed in close air support of ground troops, target destruction raids, and armed escort of other aircraft. The small size of the AH/MH-6M allows for rapid deployability in C-130, C-17 and C-5 aircraft, and extensive aircrew training allows for extremely rapid upload and download times.

#### *MH-60, DAP*

The MH-60 is capable of conducting overt and clandestine infiltration, exfiltration, and resupply of SOF across a wide range of environmental conditions. An armed version, the Defensive Armed Penetrator first used on 3-18 (DAP Blackhawk), has the primary mission of armed escort and fire support. Secondary missions of the MH-60 include C2, external load, CSAR and medical evacuation operations. The MH-60 is capable of operating from fixed-base facilities, remote sites, or oceangoing vessels. All versions are air refuelable from selected USAF and USMC aircraft. MH-60s



MH-60

are deployable in C-17 and C-5 aircraft and can be rapidly built up and employed upon arrival in theater.

#### *MH-47G*

The MH-47G is a heavy assault helicopter based on the CH-47 airframe, specifically designed and built for the special operations aviation mission. It has a totally integrated avionics subsystem along with multi-mode radar and aerial refueling capability. In addition to its capability to overtly and clandestinely infiltrate, exfiltrate and resupply SOF across a wide range of environmental conditions, MH-47s provide the ability to support combat operations at extremely high altitudes. The MH-47 is self-deployable when supported by aerial tankers and is deployable in C-17 and C-5 aircraft.



MH-47G

#### *Unmanned Aircraft Systems (UAS)*

The MQ-1C Grey Eagle and RQ-7B Shadow 200 are being deployed to support SOF with SOF-dedicated intelligence, surveillance, and reconnaissance (ISR) capabilities. Ongoing efforts to expand their use are underway.



# Chapter 4. U.S. Naval Special Operations Forces

## Naval Special Warfare Command (NAVSPECWARCOM, also NSWC)

**N**aval Special Warfare Command was established 6 April 1987 at the Naval Amphibious Base, Coronado, California, and is the naval component of the USSOCOM.

**Mission.** NAVSPECWARCOM recruits, organizes, mans, equips, trains, educates, sustains, and maintains combat readiness; and deploys assigned AC and RC Naval Special Warfare (NSW) forces and personnel to accomplish special operations missions assigned by CDRUSSOCOM and/or GCCs employing SOF.



Note that the terms NSW forces and NAVSOF are used interchangeably. The term NAVSOF is more easily articulated and understood in the joint arena, as it is consistent with commonly used terms for Army (ARSOF) and Air Force (AFSOF) special operations forces.

NSW prepares and deploys individuals, elements and forces with capability across the spectrum of defense, from cooperation to combat. NSW is an extreme-environment force, operating deep at sea or high in the mountains. Direct action, special reconnaissance, and the sea are its strengths, but they serve and succeed as our Nation needs. Honor, courage and commitment are their character. As with the other SOF components, the strength of NSW lies with its people.

**NAVSPECWARCOM Chain of Command.** The commander Naval Special Warfare Command (CNSWC) is an echelon II commander, the Navy SOF component commander under, and reporting directly to, CDRUSSOCOM.

CNSWC exercises OPCON (delegated by CDRUSSOCOM) of all U.S.-based NSW forces. CNSWC

exercises administrative control (ADCON) over all NSW forces in accordance with CDRUSSOCOM and Chief of Naval Operations (CNO) guidance. For Navy-specific administrative and other matters CNSWC reports directly to the CNO. CNSWC develops the Program Objective Memorandum (POM) and Budget Estimate Submission (BES) for CDRUSSOCOM (MFP-11) and Navy (MFP-2) and ensures adherence to CNO special-interest items.

NAVSPECWARCOM organization is shown in Figure 4-1.

**Naval Special Warfare Mission.** Naval Special Warfare provides an effective means to apply counterforce in conjunction with national policy and objectives across the spectrum of hostilities from peacetime operations to limited war to general war. NSW forces focus on the conduct of the following core activities of special operations:

- a. Direct action
- b. Special reconnaissance
- c. Foreign internal defense
- d. Counterterrorism
- e. Information operations
- f. Security force assistance
- g. Counterinsurgency
- h. Activities specified by the President of the United States

Additionally, NSW forces are involved in other activities, such as; unconventional warfare, counterdrug, personnel recovery, and special activities. NSW also provides maritime-specific special operations to meet U.S. Navy fleet requirements.

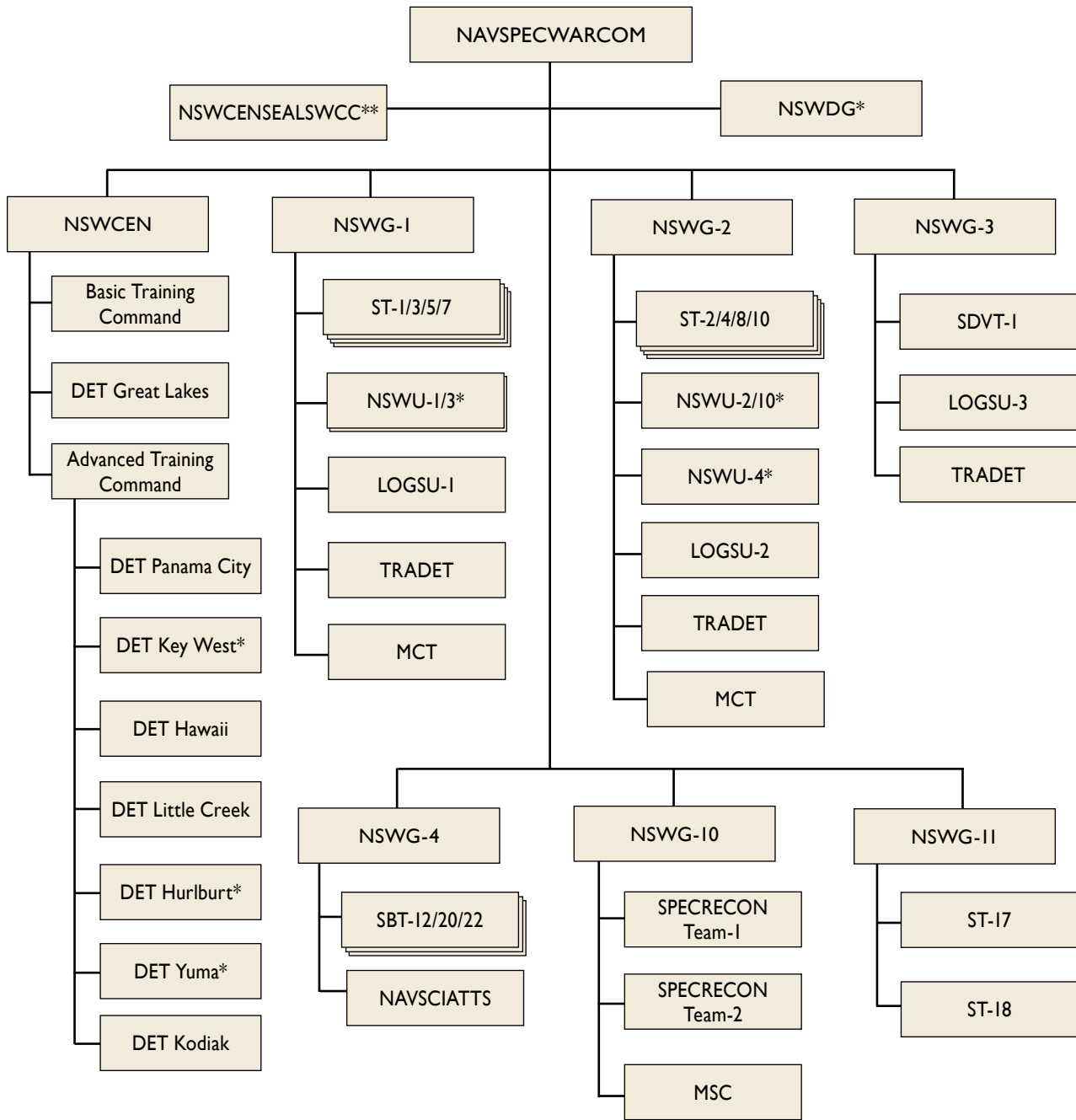

\* ADCON Only

\*\* Additional Duties to NSW. OPCON to Naval Education and Training Command

Figure 4-1. NAVSPECWARCOM Organization Chart

## Naval Special Warfare Personnel

### Naval Special Warfare Officer

NSW officers go through the sea, air, land (SEAL) training pipeline as enlisted personnel. NSW officers will attend the six-month Basic Underwater Demolition/SEAL (BUD/S) with enlisted personnel but then will attend a five-week Junior Officer Training Course (JOTC). Upon completion of JOTC, the officers continue with the Basic Airborne Course; survival, evasion, resistance, and escape (SERE) training; and a 19-week SEAL Qualification Training (SQT) course. An NSW officer can expect to spend his entire career in a variety of special operations assignments ranging from operational SEAL, SEAL delivery vehicle (SDV), and special boat teams to NSW, Navy staff, and Joint Staff tours.

### Navy Enlisted SEAL

The Navy enlisted SEAL is a highly competent and qualified member of the special operations community. All Navy SEALs go through the six-month BUD/S training at the Naval Special Warfare Center. Upon completion of BUD/S, all SEALs attend Basic Airborne and SERE training and then undergo SQT. Those who graduate are awarded the Trident Navy badge, which signifies a qualified SEAL. At this time SEALs also earn

the Navy rating of Special Warfare Operator (SWO). After attending a 19-week course, they report to their first operational SEAL or SDV Team. SEAL operators assigned to an SDV Team must also complete SDV School, generally en route to or within three months of arrival at their new command.

The process of training and education is continued throughout their careers through a combination of formal and informal processes including on-the-job skills training, attendance at various service or SOF training courses, and civilian courses of instruction. Once qualified, an enlisted SEAL can expect to spend the remainder of his career in the special operations community.

### Special Warfare Combatant-craft Crewman

Special Warfare Combatant-Craft Crewmen (SWCC) are specially selected and trained SOF who operate NSW combatant and other craft in maritime, coastal, and riverine environments. They conduct special operations such as over-the-beach and other insertion/extraction of SOF; waterborne guard post; maritime interception operations/visit, board, search and seizure; coastal patrol and interdiction, special reconnaissance, and FID, with or without SEALs or other SOF.



Navy SEALs perform advanced cold weather training in Alaska.



## NAVSPECWARCOM Organizations

**S**WCC initial pipeline training consists of three weeks of Basic Orientation, five weeks of Basic Crewman Training, followed by 20 weeks Crewman Qualification Training. Upon completion of the pipeline training, SWCC personnel receive their Special Warfare Boat Operator (SB) designator and are awarded the SWCC pin. The SWCC community is limited to enlisted and chief warrant officers. After pipeline training, SWCCs are assigned to special boat teams where they will be assigned to boat detachments. SWCC personnel will spend the majority of their careers within NSW but may also include service and joint assignments.

### *Naval Special Warfare Center (NAVSPECWARCEN/NSWCEN)*

The Naval Special Warfare Center is located at the Naval Amphibious Base Coronado, California. NSWCEN is an echelon III command under the OPCON and ADCON of NSWC. NSWCEN exercises OPCON and ADCON of subordinate commanders and assigned forces for CNSWC.

#### *Mission*

The NSWCEN has two missions: To select, train, and qualify men to become SEALs and Special Warfare Combatant Crewmen; and to provide advanced individual skills training to the men and women of the NSW community for the duration of their careers. This is accomplished through two subordinate commands, the Basic Training Command and the Advanced Training Command, respectively.

The NSWCEN is the educational and professional training center for NSW. As such, it is responsible for individual SEAL and SWCC selection and their basic and advanced training.

#### *Basic Training Command*

The Basic Training Command is an NSWCEN subordinate command (echelon IV) located at Coronado, California. The Basic Training Command mission is to conduct special operations training for U.S. and foreign armed forces and other designated personnel in basic NSW TTPs and equipment and to award the SEAL and SWCC Navy enlisted classification to qualified U.S. forces.

#### *Advanced Training Command*

The Advanced Training Command is an NSWCEN subordinate command (echelon IV) located in Coronado, California. The Advanced Training Command, with its subordinate training detachments located throughout the United States, provides advanced individual skills training, to include language training and education. Its mission is to provide NSW forces with standardized, accredited, and Chief of Naval Education and Training-approved advanced training and curriculum to support NSW community recognized tasks, conditions, and standards.

#### *Naval Special Warfare Detachment Kodiak*

Detachment Kodiak is located in Kodiak, Alaska. It is a small training command that specializes in SQT students, SEAL platoons, and special boat team detachments in maritime cold-weather operations. Units train in long-range maritime navigation, across-the-beach operations, and other cold-weather operations.

#### *Naval Special Warfare Center for SEAL and SWCC*

The Naval Special Warfare Center for SEAL and SWCC (NSWCENSEALSWCC) is an echelon III command under Naval Education Training Command (NETC) with additional duty reporting requirements to NSWC. The NSWCENSEALSWCC Commander is a SEAL O-6 responsible for the career professional development and education of the NSW community.

The NSWCENSEALSWCC mission is the proponent for career management, warrior development and selection, and PME. Provide innovative solutions that optimize human capital and war fighting ability.

#### *Naval Special Warfare Development Group*

The Naval Special Warfare Development Group (NSWDG) is located at the Fleet Combat Training Center, Dam Neck, Virginia. The NSWDG mission is to provide centralized management for the test, evaluation, and development of equipment technology and TTP for NSW.

## Naval Special Warfare Groups

### Naval Special Warfare Group Mission

The mission of the Naval Special Warfare Group (NSWG) is to train, equip, deploy and support assigned NSW forces, including OPCON and ADCON of assigned forces. When directed, NSWGs command and control NSW and/or other forces in exercises and operations.

### Naval Special Warfare Group Tasks

Tasks common to NSWGs are listed below:

- a. Train, equip, support, and deploy assigned NAVSOF
- b. Perform type-commander functions for assigned forces including readiness evaluation
- c. Plan, coordinate, and conduct unilateral, joint, combined, and fleet special operations and exercises as required
- d. Establish and function as the naval component—Naval Special Operations Task Force (NAV-SOTF/NSWTF)—of a Combined and/or Joint special operations task force or numbered fleet for contingency operations or major theater exercises as directed
- e. Provide forces and intelligence capabilities to support exercises and operations
- f. Provide automated information system support to the staff and subordinate commands
- g. Support subordinate commands with message dissemination, financial management, medical, legal, chaplain, research, development, testing, and evaluation, safety and explosive safety, and travel orders processing
- h. Support CNSWC planning, programming, and budgeting efforts
- i. In coordination with NSWC develop, test, and evaluate TTPs, ordnance, and equipment
- j. Train and integrate reserve forces
- k. Support GCC, Navy, and USSOCOM planning as required/directed
- l. Maintain visibility of assets through coordinated management of the Table of Organic Allowance
- m. Exercise ADCON of assigned NSW forces when deployed

### Naval Special Warfare Group Organization

An NSWG is an echelon III command under the OPCON and ADCON of NAVSPECWARCOM (echelon II). NSWG commanders (CNSWGs) exercise OPCON and ADCON of subordinate commanders and assigned forces for CNSWC. As such, NSWG commanders are accorded the traditional USN honorific title of Commodore. There are six NSWGs.

- a. NSWG-1 and NSWG-2 exercise OPCON and ADCON of the SEAL Teams. NSWGs 1 and 2 also exercise ADCON of their respective NSWUs and detachments. COCOM of the NSWUs is assigned to USSOCOM
- b. NSWG-3 exercises OPCON and ADCON of the SEAL delivery vehicle teams
- c. NSWG-4 exercises OPCON and ADCON of the special boat teams and the Naval Small Craft Instruction and Technical Training School (NAVSCIATTS)
- d. NSWG-10 exercises operational control and administrative control of Special Reconnaissance Team 1, Special Reconnaissance Team 2, and the Mission Support Center
- e. NSWG-11 exercises OPCON and ADCON of NSW Reserve Forces (SEAL Teams 17 and 18)

**Naval Special Warfare Training Detachments.** NSWG 1, 2, and 3 Training Detachments (TRADETs) execute responsibilities for coordinating, directing, and conducting deployment training and readiness evaluations.

**Naval Special Warfare Group 1.** NSWG-1 Mission Statement—the commander, Naval Special Warfare Group ONE (CNSWG-1) is responsible for organizing, manning, training, educating, equipping, deploying and sustaining assigned forces to conduct special operations, principally in support of USCENTCOM and USPACOM, but also in support of other combatant commander requirements. Responsibilities include exercise of OPCON and ADCON of subordinate commands and activities including SEAL Teams 1, 3, 5 and 7, Logistics and Support Unit 1, a mobile communications team, and other units and activities; exercise ADCON of Naval Special Warfare Unit 1 and Naval Special Warfare Unit 3; and act as CNSWC executive agent for NSW support to USCENTCOM and USPACOM.

CNSWG-1 unique responsibilities include:

- a. Act as CNSWC's executive agent for advising on NSW support of the requirements of Commanders, USPACOM and USCENTCOM
- b. Coordinate NSW support of TSOCs/Fleet Commander planning efforts as required in conjunction with the applicable NSWU. (This function is a primary responsibility of NSWUs.)
- c. Be prepared to deploy as the core of a JSOTF

**Naval Special Warfare Group 1 Subordinate Commands.** NSWG-1 subordinate commands are as follows:

- a. SEAL Team 1 (ST-1)
- b. SEAL Team 3 (ST-3)
- c. SEAL Team 5 (ST-5)
- d. SEAL Team 7 (ST-7)
- e. Logistics and Support Unit 1 (LOGSU-1)
- f. Mobile Communications Team (MCT)
- g. Naval Special Warfare Unit 1 (NSWU-1) (ADCON only, COCOM to USSOCOM, OPCON to SOCAFRICA)
- h. Naval Special Warfare Unit 3 (NSWU-3) (ADCON only, COCOM to USSOCOM, OPCON to SOCCENT)
- i. Training Detachments (TRADETS)

**Naval Special Warfare Group 2.** NSWG-2 Mission Statement—the commander, Naval Special Warfare Group TWO (CNSWG-2) is responsible for organizing, manning, training, educating, equipping, deploying and sustaining assigned forces to conduct special operations, principally in support of USEUCOM and USSOUTHCOM, but also in support of other combatant commander requirements. Responsibilities include exercise of OPCON and ADCON of subordinate commands and activities including SEAL Teams 2, 4, 8 and 10, Logistics and Support Unit 2, a mobile communications team, and other units and activities; exercise ADCON of Naval Special Warfare Unit 2 and Naval Special Warfare Unit 4; and act as CNSWC executive agent for NSW support to USEUCOM and USSOUTHCOM.

CNSWG-2 unique responsibilities include:

- a. Act as CNSWC's executive agent for advising on support of Commander, USEUCOM and Commander, USSOUTHCOM

- b. Coordinate NSW support of TSOCs and Fleet Commander planning efforts as required in conjunction with the applicable NSWU (this function is a primary responsibility of NSWUs)
- c. Be prepared to deploy as the core of a JSOTF

**Naval Special Warfare Group 2 Subordinate Commands.** NSWG-2 subordinate commands are as follows:

- a. SEAL Team 2 (ST-2)
- b. SEAL Team 4 (ST-4)
- c. SEAL Team 8 (ST-8)
- d. SEAL Team 10 (ST-10)
- e. Logistics and Support Unit 2 (LOGSU-2)
- f. Mobile Communications Team (MCT)
- g. Naval Special Warfare Unit 2 (NSWU-2) (ADCON only, COCOM to USSOCOM, OPCON to SOCEUR)
- h. Naval Special Warfare Unit 10 (NSWU-10) (ADCON only, COCOM to USSOCOM, OPCON to SOCAFRICA)
- i. Naval Special Warfare Unit 4 (NSWU-4) (ADCON only, COCOM to USSOCOM, OPCON to SOCSOUTH)
- j. Training Detachments (TRADETS)

**Naval Special Warfare Groups 3 and 4.** NSWG-3 provides special operations subsurface mobility capabilities, platforms and personnel. NSWG-4 provides special operations surface mobility capabilities, platforms and personnel.

The following are tasks common to both NSWG-3 and NSWG-4:

- a. Provide personnel augmentation to deployed forces as required
- b. Supervise configuration control of assigned combatant craft and submersibles
- c. Coordinate, plan, and administer maintenance/repair availabilities and execute emergency repairs as feasible on all major equipment
- d. In coordination with NSW, contribute to specialized weapons and equipment research, development, test and evaluation (RDT&E)
- e. Support CCDR planning efforts as required

**Naval Special Warfare Group 3.** NSWG-3 Mission Statement—the commander, Naval Special Warfare



NSWU-2 personnel board the salvage ship USNS Grasp during a Maritime Craft Air Delivery System drop in joint exercise Flexible Leader 07.

Group 3 (CNSWG-3) is responsible for organizing, manning, training, educating, equipping, deploying and sustaining assigned forces, principally for undersea and other maritime special operations in support of CCDRs. Responsibilities include exercise of OPCON and ADCON of subordinate commands and activities including SEAL Delivery Vehicle Team 1, and advising CNSWC on undersea and other designated combat development areas.

CNSWG-3 unique responsibilities include:

- a. Coordinate combatant submersible integration with host ships and appropriate combatant submersible issues with Commanders Submarine Forces Atlantic/Pacific
- b. RDT&E of combatant submersibles and associated specialized weapons and equipment in coordination with NSWC

**Naval Special Warfare Group 3 Subordinate Commands.** NSWG-3 subordinate commands are as follows:

- a. SEAL Delivery Vehicle Team 1 (SDVT-1)
- b. NSWG-3

- c. Logistics and Support Unit 3 (LOGSU-3)
- d. Training Detachments (TRADETS)

**Naval Special Warfare Group 4.** NSWG-4 Mission Statement—the commander, Naval Special Warfare Group 4 (CNSWG-4) is responsible for organizing, manning, training, educating, equipping, deploying and sustaining assigned forces principally for surface combatant and other maritime special operations in support of CCDRs. Responsibilities include the exercise of OPCON and ADCON of subordinate commands and activities including Special Boat Teams 12, 20, 22, and the NAVSIATTS; and advising CNSWC on combatant craft and other designated combat development areas.

CNSWG-4 unique responsibilities include the following:

- a. In coordination with NSWC, contribute to the RDT&E on surface craft and associated weapons and equipment
- b. Serve as the NSWC Executive Agent for SWCC community management and professional development

**NSWG 4 Subordinate Commands.** NSWG-4 subordinate commands are as follows:

- a. Special Boat Team 12 (SBT-12), Coronado, California
- b. Special Boat Team 20 (SBT-20), Little Creek, Virginia
- c. Special Boat Team 22 (SBT-22), Stennis, Mississippi
- d. Naval Small Craft Instruction Technical and Training School (NAVSCIATTS), Stennis, Mississippi

**Naval Special Warfare Group 10.** NSWG-10 IOC was completed in May 2011. NSWG-10's unique responsibilities include the following:

- a. Training, equipping, readiness assessment and deployment of Naval Special Warfare forces
- b. Training, equipping, and deploying combat support personnel and capabilities in support of the deployed NWS forces and other requirements
- c. Providing Combat Service Support (CSS) including deployed personnel/detachments, for

assigned forces and in support of NSWG-3 and NSWG-4 forces and units when directed

- d. Maintaining the Civil Engineering Support Equipment (CESE) for geographically collocated subordinate organizations

**Naval Special Warfare Group 10 Subordinate Commands.** At IOC (2011) NSWG-10 subordinate commands are as follows:

- a. Special Reconnaissance Team 1 (SPECRECON Team-1)
- b. Special Reconnaissance Team 2 (SPECRECON Team-2)
- c. Naval Special Warfare Mission Support Center (MSC)

**Naval Special Warfare Group 11.** NSWG-11 organizes, mans, trains, educates, equips, deploys, and sustains assigned NSW Reserve Component units and personnel in support of Naval Special Warfare and Joint Special Operations commanders worldwide. Responsibilities include the OPCON and ADCON of subordinate commands and activities, including SEAL Teams 17 and 18, and advising CNSWC on NSW Reserve Force matters. NSWG-11 tasks include the following:

- a. Theater Engagement missions (JCET/FID)
- b. Battle Staff support to deployed SOF
- c. Provide training, logistics, intelligence, and maintenance support for deployed NSW forces
- d. When tasked, support Operational Preparation of the Environment (OPE)
- e. When tasked, provide operational Reserve units in support of deployed NSW forces

**Naval Special Warfare Group 11 Subordinate Commands.** NSWG-11 subordinate commands are as follows:

- a. SEAL Team 17 (ST-17), Coronado, California
- b. SEAL Team 18 (ST-18), Little Creek, Virginia

### ***Logistics and Support Units 1, 2, and 3 (LOGSU 1/2/3)***

#### ***LOGSU Mission and Tasks***

LOGSUs organize, man, train, equip, and deploy personnel and equipment to provide CSS, including

administrative, maintenance, logistical, and medical support. LOGSU tasks include:

- a. Logistics support including provision of deployable Combat Service Support Troops (CSSTP), contracting, supply, equipment maintenance, facilities management, military construction, hazardous materials, environmental, combat systems support, Table of Organic Allowance and ordnance management to NSWGs and ST/ SBT/SDVTs in CONUS
- b. Provide range/training facility support to include logistics, messing, maintenance, scheduling, and operation
- c. Conduct maintenance in accordance with the Navy's Preventive Maintenance System (PMS).
- d. Provide the following (departmental) support to the SEAL/SDV Teams: Supply, PMS, Diving, Ordnance, Air Operations, First Lieutenant/Engineering, Administration, Career Counseling, Automated Information System, and Medical
- e. Provide range/training facility support to include logistics, messing, maintenance, scheduling, and operation

#### ***LOGSU Organization***

LOGSUs 1, 2, and 3 are echelon IV commands under NSWG-1, NSWG-2, and NSWG-3, respectively. A LOGSU is commanded by an O-5 Supply Corps officer and is organized into a headquarters element, administrative departments, and operational elements consisting of four Combat Service Support Troops (CSSTPs). A CSSTP normally consists of 17 personnel and provides CSS to deployed NSW forces.

#### ***LOGSU Capabilities***

Each CSSTP provides the following:

- a. Coordination with and through the appropriate CCDR component commands and offices to provide support to forward deployed NSW forces
- b. Contracting capability and expertise including small purchases and leases, as authorized by the theater executive agent, and in coordination with the GCC J4 as appropriate. CSSTP contracting authorities provide the CSSTP

- supply representative with their supply reissue, requisition, procurement, storage, distribution, security, and transportation requirements
- c. Force embarkation, transportation, equipment maintenance, combat cargo handling, in-theater logistics, construction, contingency engineering, camp development and maintenance. They also provide for limited force protection and perimeter defense. A CSSTP may require reserve augmentation to fully perform its mission
  - d. Assistance with chemical, biological, radiological, nuclear, and high-yield explosives decontamination operations

### **Special Reconnaissance Team 1 and 2 (SPECRECON Team 1/2)**

The SPECRECON mission is to train and deploy specially trained combat elements and personnel. SPECRECON Team 1/2 organize, man, train, equip, and deploy elements to provide special operations intelligence collection, ISR, and analytical capabilities.

#### **SPECRECON Team 1/2 Organization**

SPECRECON Team 1/2 normally provide ISR and analytical capabilities as cross functional troops (CFTPs), led by an O-3 or O-4, with one or more (normally three) subordinate cross functional teams (CFTs) for each deploying SEAL team. In addition, regional

support troops (RSTPs) support specific geographic commander requirements.

### **Mobile Communications Teams (MCTs)**

#### **MCT Mission**

MCTs organize, man, train, equip and deploy personnel and communications equipment to operate and maintain communications for NSW forces.

#### **MCT Organization**

MCTs are combat support activities under NSWG-1 and NSWG-2. An MCT has an O-3 officer-in-charge and is organized into a headquarters element, administrative departments, and operational elements.

#### **MCT Capabilities**

NSW communicators provide a variety of voice and data services for communicating with Joint and Fleet commands and units using man-portable, modular, and tactical vehicles as well as messaging systems (HF, UHF, VHF, SHF, and EHF). MCT Troops (MCTTs) are normally attached to deploying SEAL teams and provide rapidly deployable communications capabilities in austere environments.

### **SEAL Team**

SEAL Teams are echelon IV commands, subordinate to an NSWG.

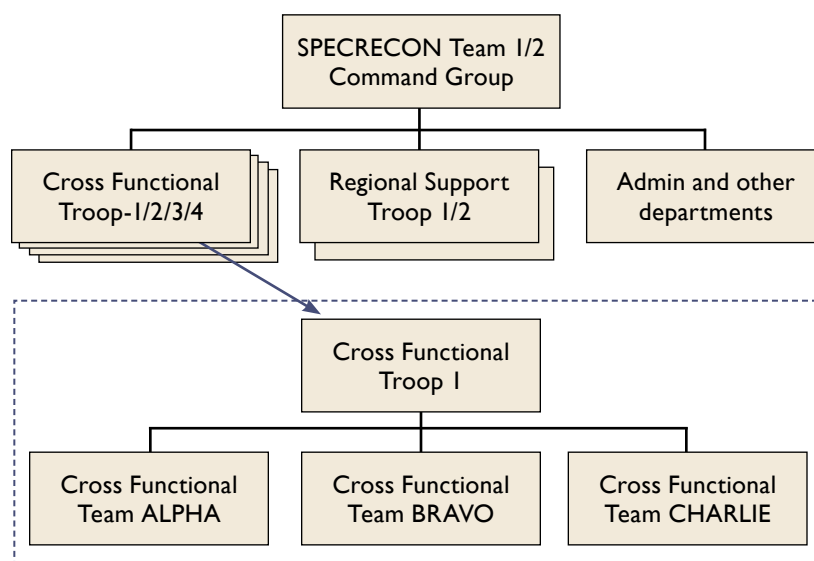

Figure 4-2. Notional Special Reconnaissance Team 1 and 2

#### **SEAL Team Organization**

A SEAL Team is commanded by a SEAL O-5. The teams have a headquarters element and normally four SEAL troops (SEALTPs). Each SEALTP consists of a small C2 element and one or more (normally two) SEAL platoons (SEAL PLTs). The SEAL PLTs are designated alphabetically within a SEAL team.

#### **SEAL Platoon**

The SEAL platoons assigned to a SEAL team are designated alphabetically, from Alpha through Hotel. A SEAL platoon normally consists of 3 officers and 16-18 enlisted men. A SEAL platoon is further divided into three

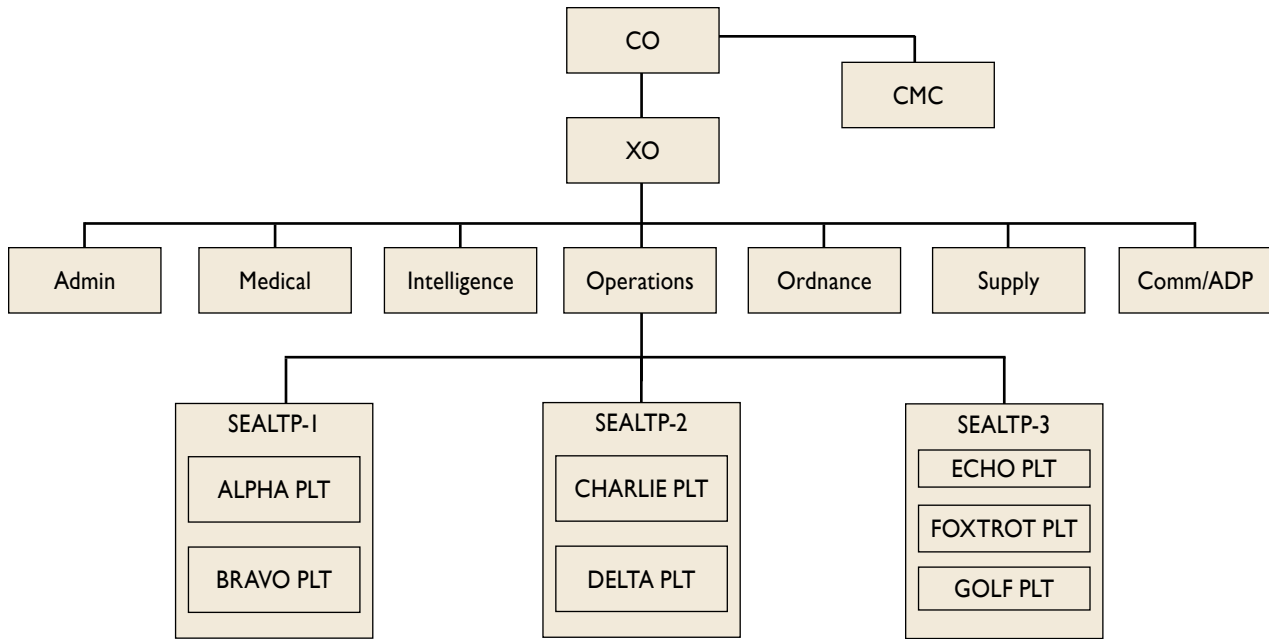

Figure 4-3. Notional SEAL Team

squads each led by a SEAL officer. The number of SEALs required for a particular mission is driven by mission requirements. A small number of SEALs task-organized for a specific mission or task is referred to as an NSW task group (NSWTG) commanded by an O-5, NSW task unit (NSWTU) commanded by an O-4, or an NSW task element (NSWTE) commanded by an O-3.

SEAL platoon personnel are dive, parachute, and demolition qualified, and proficient in small-unit tactics and maritime operations. SEAL junior enlisted personnel are assigned one or more of seven platoon department

responsibilities, or specialties which include intelligence, diving, communications, first lieutenant, ordnance, air operations, and medical.

**SEAL Capabilities**

SEAL team personnel are trained, organized, and equipped to operate in the sea, air and land domains to accomplish special operations missions. SEALs possess a high degree of proficiency in DA and SR, including sabotage, demolition, intelligence collection, hydrographic reconnaissance, as well as the training and advising of friendly military or other forces. Sub-surface vessels, surface vessels, aircraft, or land vehicles may be used for insertion and extraction of SEALs by sea, air, or land. The infiltration method chosen is dependent on the availability of platforms, the threat, and the environment. SEAL infiltration may employ fast attack submarine (SSN) and nuclear-powered cruise missile submarines—with or without dry deck shelter, SDV, surface vessels, surface swimming, combat (submerged) swimming, static-line or free-fall parachuting, helicopter (rappelling/fast-roping and helicopter sniper assaults), and mounted/dismounted patrol. While maintaining capabilities to operate in all environments (desert, arctic, littoral, riverine, mountain, jungle, and

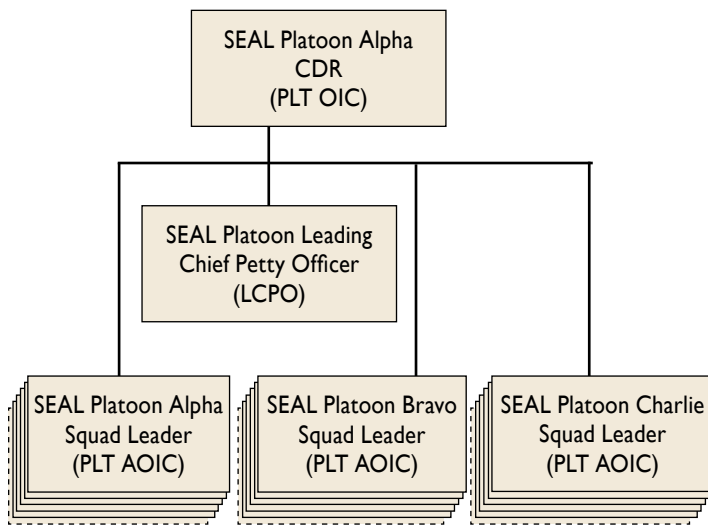

Figure 4-4. Notional SEAL Platoon Organization

urban), SEALs tailor their training and preparation to the conditions anticipated in the AO to which they are to be deployed.

All SEALs are trained in the following areas, but designated platoon members maintain a higher degree of proficiency in the following department skills:

- a. Intelligence
- b. Dive equipment maintenance and repair (open and closed-circuit)
- c. Electronics (communications and other devices)
- d. First lieutenant (sea and land mobility systems)
- e. Ordnance—arms, ammunitions, and explosives, visual augmentation system (VAS), breacher, sniper, and joint tactical air control (JTAC)
- f. Air operations equipment maintenance and repair (air assault/support, static line, and free-fall parachuting)
- g. Medical (hospital corpsman with special operations technician qualification)

**SEAL Team – Expeditionary**

Six months prior to deployment, the SEAL team (with its organic SEAL troops) assumes OPCON of assigned combat support and combat service support elements. Combat support (CS) includes a SPECRECON Team 1/2 cross functional team (CFT), explosive ordnance disposal (EOD) detachment, TCS detachment and other Joint, fleet, or SOF unit or personnel. Combat service support (CSS) elements may include a Naval construction battalion detachment (CB Det or SEABEE Det); mobile communication team troops; or individual augmentees (IA). The SEAL team and its subordinate troops may be redesignated or source provisional task organizations for specific exercises and operations. A notional deployed SEAL team provides the C2 element and core staff in support of a NSWTG, SOTF, TF, or other C2 organization as determined by the supported operational chain of command, and/or providing one or more NSWTUs in support of a NSWTG, SOTF, TF, or other C2 organization, is depicted in Figure 4-5 as configured for (notional) sustained or expeditionary combat in support of a named operation.

**Naval Special Warfare Task Force**

A NSWTF is a provisional naval special warfare organization that plans, conducts, and supports special operations in support of joint, fleet, or other commanders. It may be the naval component of a JSOTF, or its commander may command the JSOTF. It may also be the SOF component of a Navy TF. A NSWTF normally provides for command and control of two or more NSWTGs or other subordinate units. It is normally commanded by a SEAL captain (O-6), often a NSW unit commanding officer or a NSW group commander.

**Naval Special Warfare Task Group**

A NSWTG is a provisional NSW task organization that plans, conducts, and supports special operations in support of TSOCs and/or fleet commanders. It is composed of a command and control element and one or more subordinate NSWTUs or other units or forces. It is normally commanded by a SEAL team commander (O-5).

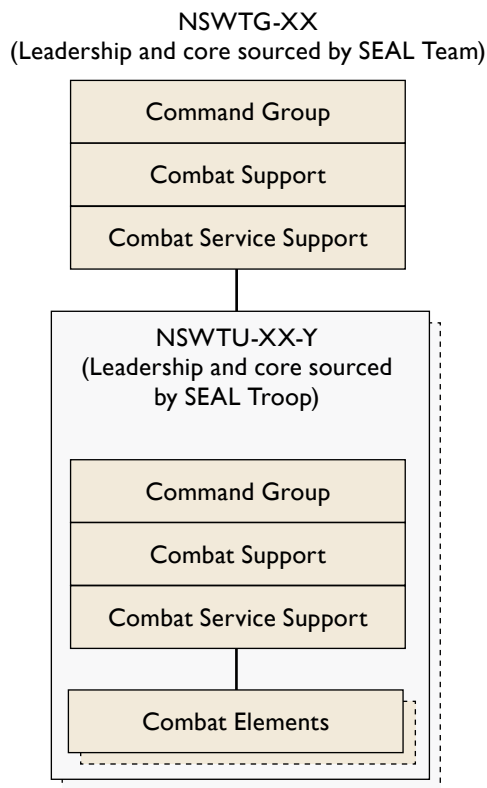

Figure 4-5. Notional Deployed NSW Organization



### Naval Special Warfare Task Unit

A NSW TU is a provisional NSW task organization consisting of a C2 element, one or more SEAL platoons, and/or other combat elements, combat support, combat service support, mobility and other attachments required to plan, C2, conduct, and sustain special operations. A NSW TU is normally commanded by a SEAL lieutenant commander (O-4) or senior lieutenant (O-3).

### Naval Special Warfare Task Element

A NSW TE is a provisional NSW task organization generally used to refer to smaller tactical/maneuver combat or combat support elements task-organized to conduct a given mission. An NSW TE is built around the core of a SEAL platoon and normally commanded by a SEAL O-3 platoon commander.

### Special Boat Teams (SBTs)

#### Special Boat Team Mission and Tasks

The mission of a SBT is to organize, man, train, equip and deploy special operations combatant craft and crews as special boat troops (SBTP) to conduct special operations.

Planning, training, and preparation tasks include:

- a. Train and equip assigned forces to meet the requirements of CCDR mission guidance letters, Fleet Exercise Publication-6, and METLs
- b. Form SBT detachments into cohesive force packages for deployment and employment

Specific SBT operational tasks include insertion and exfiltration of SOF, coastal patrol and interdiction, special operations in a riverine, coastal and maritime environment, including mobility and other support to SEALs and other SOF.

#### Special Boat Team Organization

SBTs are echelon IV commands assigned to NSWG-4. SBTs consist of maritime SOF and support personnel organized, trained, and equipped to operate and support a variety of combatant craft in maritime, coastal and riverine environments.

An SBT is commanded by an O-5 SEAL and is organized into a headquarters element, administrative and logistics support elements, and operational/combat elements normally consisting of three SBTPs. An SBTP is led by a SEAL O-3 and consists of a small C2 element, CSS and other capabilities, and one or more SB detachments (SBD). An SBD normally consists of two craft and crew (SWCC), and may include a small maintenance support team (MST). When deployed, SBTPs may be attached to a SEAL team or detach as directed to conduct operations separate from SEAL team command and control and oversight.

SBTs 12 and 20 provide Special Boat Troops-Coastal (SBTP-C) that normally consist of one combatant craft assault (CCA) detachment and three rigid-hull inflatable boat (RIB) detachments. The CCA will replace the retired Mark V Special Operations Craft. SBT 22 provides Special Boat Troops-Riverine (SBTP-R) which normally consist of two riverine special operations craft -riverine (SOC-R) detachments.

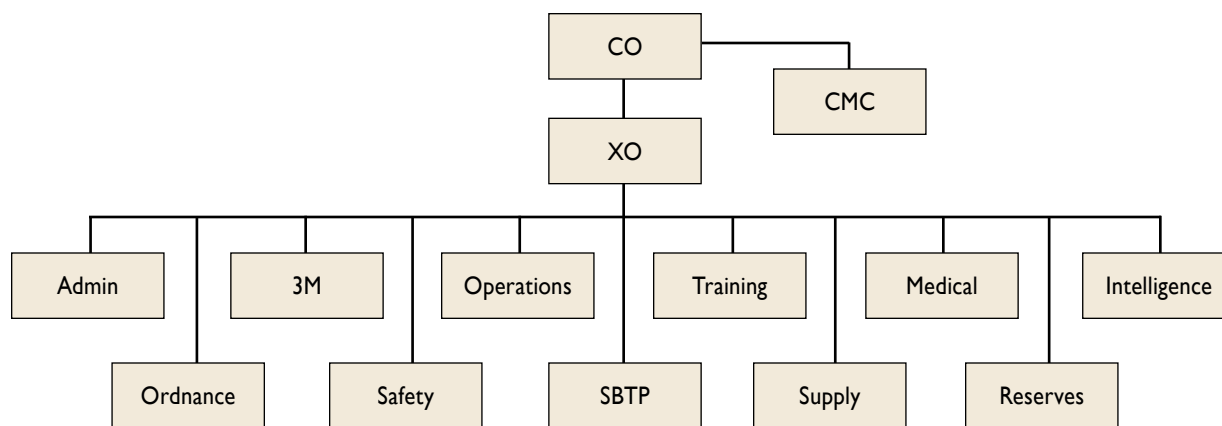

Note: SBTs 12/20 provide SBTP-C, SBT 22 provides SBTP-R

Figure 4-6. Notional Special Boat Team Organization

### *Special Boat Team Capabilities*

SBT personnel operate and maintain a variety of combatant and other craft for maritime special operations. The craft most frequently employed are high speed combatant craft designed for delivery of SOF in littoral and riverine environments. Lightly armed and armored NSW combatant craft employ stealth, surprise, speed and agility in the conduct of special operations. Like their SEAL counterparts, SWCC personnel are specially trained and selected SOF.

**Infiltration/Exfiltration.** SWCC may employ combatant or other craft to infiltrate and exfiltrate SEALs and other SOF, allied and/or indigenous forces, or noncombatants. Additionally, SBDs may be used to transport limited numbers of detainees from SOF objectives to afloat or ashore temporary holding facilities as well as personnel recovery.

**Coastal Patrol and Interdiction.** SWCC may conduct coastal patrol and interdiction and may provide limited naval gunfire support (to maneuver forces).

**Command, Control, and Communication.** SWCC may employ their craft to provide tactical secure voice communications to include acting as a mobile or fixed combat communications relay.

**Intelligence.** SWCC may employ craft to conduct reconnaissance and surveillance, as well as act as platforms for employment of signals intelligence personnel and their equipment.

**Mobility.** NSW RIB, CCA and SOC-R detachments can be transported to an AO overland, using either vehicle line-haul or organic prime movers, or by sea, or airlift. NSW combatant craft may operate from, or be supported by, U.S. Navy noncommissioned ships (USNS) and allied ships. This includes operating with a ship that is acting as an afloat forward staging base (AFSB) and able to refuel, rearm, launch, and recover or otherwise provide support that extends the range, endurance, and reach of combatant or other craft for a given mission.



Special Warfare Combatant-craft Crewmen (SWCC) from Special Boat Team 20 maneuver into a stack formation after completing a free-fall parachute jump from an Air Force C-130 at approximately 12,500 feet altitude.

**Noncombat Operations.** SBTs may support operational test and evaluation, provide emergency disaster relief or evacuation assistance, and conduct FID. FID often involves training on indigenous or host/partner nation craft and equipment.

### *Special Boat Team 12 (SBT-12)*

SBT-12 is based in Coronado, California. It is commanded by a Navy commander (O-5) and consists of a headquarters element, 16 RIB detachments, and CCA. Each detachment normally consists of two boats with crews. SBT-12 supports special operations missions for West Coast NSW forces and deploys detachments throughout the Pacific and Central Africa AORs. SBT-12 is under the operational and administrative control of NSWG-4.

### *Special Boat Team 20 (SBT-20)*

SBT-20 is based in Little Creek, Virginia. It is commanded by a Navy commander (O-5), and consists of a headquarters element and 13 RIB detachments and CCA. Each detachment normally consists of two boats. SBT-20 supports special operations missions for East Coast NSW forces and deploys detachments to the European, Southern and African theaters of operation. SBT-20 focuses on providing operational support to the

European and Atlantic theaters of operations. SBT-20 is under the operational and administrative control of NSWG-4.

### ***Special Boat Team 22***

Special Boat Team 22 (SBT-22) is based in Stennis, Mississippi. It is commanded by a Navy commander (O-5) and consists of a headquarters element, two patrol boat light (PBL) detachments (used for training purposes only), and eight SOC-R detachments. Each detachment consists of two boats with crews. SBT-22 deploys its riverine forces globally. SBT-22 is under the operational and administrative control of NSWG-4.

### ***Naval Small Craft Instruction and Technical Training School***

NAVSCIATTS is an NSWG-4 subordinate command (echelon IV) located at the Stennis Space Center, Mississippi.

The mission of NAVSCIATTS is to conduct FID, SFA, and other special operations tasks in support of CCDRs in accordance with CDRUSSOCOM priorities using mobile training teams and in-resident training to prepare partner nation forces to conduct small craft operations in riverine or littoral environments.

### ***SEAL Delivery Vehicle Team***

The SEAL Delivery Vehicle Team (SDVT) operates the SDV, dry deck shelter (DDS), and related equipment in the conduct of special operations.

#### ***SDVT Mission and Tasks***

The SDVT mission is to organize, man, train, equip, and deploy forces to employ combatant submersibles in special operations, and other special operations as tasked.

#### ***SDVT Planning, Training, and Preparation Tasks***

Train and equip assigned forces to meet the requirements of CCDR mission guidance letters, METL, and other taskings.

#### ***SDVT Operational Tasks***

SDVT-specific tasks include employment of combatant submersibles to conduct special operations.

#### ***SEAL Delivery Vehicle Team Organization***

The SDVT is organized into a headquarters element, administrative and logistics support elements, and



Members of SEAL Delivery Vehicle Team Two prepare to launch on a training exercise from the deck of the submarine USS Philadelphia. SEAL delivery vehicles are used to transport Navy SEALs from their submerged host submarine to their targets while remaining underwater and undetected.

operational/combat elements consisting of SDV troops (SDVTPs), and other task-organized elements.

#### ***SDVT SDV Troop***

An SDVTP consists of a C2 element, SDV platoon and DDS platoon. An SDV platoon is normally composed of two SDVs, SEALs including SDV driver and navigator, and support personnel.

### ***Naval Special Warfare Units***

NSWUs (not a NSW Task Unit, which is a provisional task organization) normally exercise OPCON of all NSW forces in the respective GCC's AOR. ADCON of NSW forces is exercised by their parent NSWG. The

commanding officer of an NSWU is an NSW captain (O-6) and is the maritime component of the TSOC. NSWU COs may be assigned (and receive designations for such) to act as a commander under the TSOC and/or as a commander under the Navy component (fleet) commander for a specified operation, exercise or other purpose. In this case, the NSWU CO will be designated as either an NSWTF, NSWTG or other appropriate designation under the Joint SOF commander, and/or as a CTF subordinate to the Navy commander. NSWUs are assigned COCOM to USSOCOM. OPCON of the NSWU is exercised for the GCCs through the TSOCs.

## Naval Special Warfare Weapons Systems

### Combatant Craft Medium (CCM)

The CCM is a reconfigurable, multi-mission maritime surface tactical mobility craft with a primary mission to insert and extract SOF in a medium threat environment. It is slated to replace the NSW RIB and retired MK V craft. The CCM incorporates enhanced performance above current platform capabilities including; survivability, shock mitigation, speed, connectivity, and maneuverability, meeting SOF requirements to operate in future environments.



Combatant Craft Medium

#### Design Characteristics

Length:	60 feet, 7 inches
Payload:	10,000 pounds
Speed:	40 knots

### Special Operations Craft–Riverine (SOC-R)

The 33-foot SOC-R is a special operations platform, fully capable of operation in riverine, littoral and light-weather coastal environments. The SOC-R is a quick, maneuverable craft that can traverse shallow, restricted waterways with little effect from surface or subsurface obstacles, while carrying large payloads. The SOC-R is designed to withstand the forces generated by operating the boat at maximum attainable speed in all directions in Sea State 2 (1–3 foot significant wave height) and with judicious handling in Sea State 3 (4–5 foot significant wave height). Noteworthy characteristics of the craft include its low noise signature (virtually undetectable from noise at idle), its extreme maneuverability, and shallow draft.

The primary mission of the SOC-R involves clandestine insertion and extraction of SOF into a low-to medium-threat environment in a riverine arena. Secondary mission capabilities include providing fire support,

serving as a staging area and reconnaissance platform, acting as a waterborne guard post, and operating as an interdiction or SAR craft.

The fact that the SOC-R is water-jet propelled allows for shallow water operations at full throttle, providing quick extractions if the situation warrants. The large bow and stern gunwale flats are designed for quick embarkation and debarkation. The ¼-inch aluminum-hull bottom, coupled with zero appendage drag of the water jet, allows for operating in debris-congested waters. The craft's ability to pivot lets it operate in narrow waterways. The mission capabilities of the SOC-R are directly related to its performance characteristics and configuration. The SOC-R has been certified for low velocity air drop (LVAD), internal air transport (IAT), and external air transport.



Two Special Operations Craft–Riverines maneuver during live-fire training.

#### Design Characteristics

Length overall:	33 feet, 0 inches
Beam overall:	9 feet, 0 inches
Fuel capacity:	191 gallons
Propulsion engine:	Yanmar 6LY2_STE diesels/440 Hp each water jet drive
Propulsor:	2 HG Hamilton jet drives

#### Operational Weight Data

Light (w/full fuel):	8,893 pounds
Full load weight:	12,925 pounds

#### Performance (Full Load)

Acceleration (0- 25 knots):	25 seconds
Max operational sea state:	Sea State 2
Max capable sea state:	Sea State 3

### Ancillary Systems

Weapons:	2 forward/3 aft: M-240 7.62 mm, MK-19, M2HB .50 cal (port, starboard, centerline aft)
Navigation:	Radar/GPS
Communications:	UHF/VHF LOS, UHF SAT LVAD/IAT

### Rigid hull Inflatable Boat (RIB)

The 11-meter RIB is a high-speed, high-buoyancy, extreme-weather craft with the primary mission of insertion/extraction of SEAL tactical elements from enemy occupied beaches.

The RIB is constructed of glass-reinforced plastic with an inflatable tube gunwale made of a new hypalon neoprene/nylon reinforced fabric.

The RIB has demonstrated the ability to operate in light-loaded conditions in Sea State 6 and winds of 45 knots. For other than heavy weather coxswain training, operations are limited to Sea State 5 and winds of 34 knots or less.

The 11-meter RIB (NSW RIB) carries a crew of three and allows for a SEAL squad delivery capability.



Naval Special Warfare Combatant-craft crewmen operate a Rigid-hull Inflatable Boat from a forward location. The RIB is equipped with M-2 .50-caliber machine guns.

### Design Characteristics

Length:	11 meters
Beam:	11 feet
Draft:	3 feet
Weight:	14,700 pounds
Propulsion:	2 Caterpillar 3126 DITA
Complement:	3 crew/8 passengers

Radios:	Radar, HF, UHF, VHF, satellite communications (SATCOM)
---------	--

### Performance Criteria

Seaworthiness:	Sea State 5
Armament:	Forward and aft mounts capable of M-240, M-2, or MK 19

### Combat Rubber Raiding Craft (CRRC)

The CRRC is used for clandestine surface insertion and extraction of lightly armed SOF. They are employed to land and recover SOF from over the horizon. The CRRC is capable of surf passages. The CRRC may be launched by air (airdrop/helo cast) or by craft [landing craft, utility (LCU) and landing craft, motorized (LCM)]. It may also be deck launched or locked-out from submarines. It has a low visual electronic signature and is capable of being cached by its crew once ashore. It uses one 35 to 55 horsepower engine.

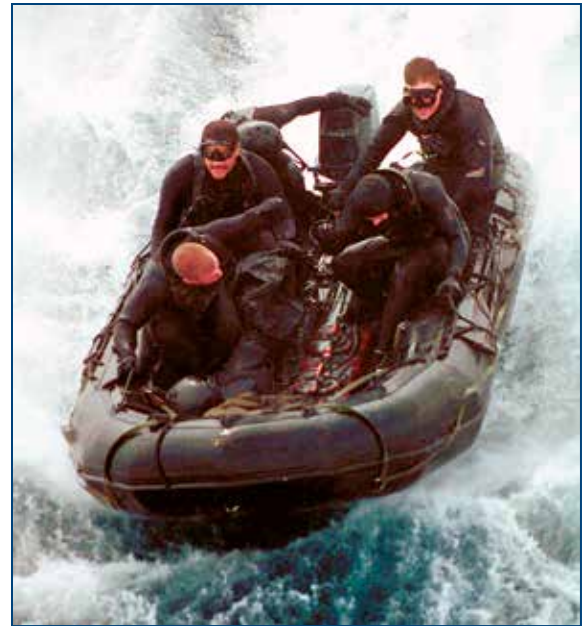

Combat Rubber Raiding Craft

### Design Characteristics

Length:	15 feet, 5 inches
Beam:	6 feet, 3 inches
Draft:	2 inches
Weight:	65 pounds without motor or fuel
Speed:	8 knots, no load
Range:	Dependent on fuel carried
Complement:	8 max

### *SEAL Delivery Vehicle (SDV) MK VIII*

The SDV MK VIII is a “wet” submersible, designed to carry combat swimmers and their cargo in fully flooded compartments. Submerged, operators and passengers are sustained by the individually worn underwater breathing apparatus. Operational scenarios for the vehicle include underwater mapping and terrain exploration, location and recovery of lost or downed objects, reconnaissance missions, and limited direct action missions.

The vehicle is propelled by an all-electric propulsion subsystem. Buoyancy and pitch attitude are controlled by a ballast and trim system; control in both the horizontal and vertical planes is provided through a manual control stick to the rudder, elevator, and bow planes. A computerized Doppler navigation sonar displays speed, distance, heading, altitude, and other piloting functions. Instruments and other electronics units are housed in dry, watertight canisters. The special modular construction provides easy removal for maintenance.

Major subsystems are hull, propulsion, ballast/trim, control, auxiliary life support, navigation, communications, and docking sonar.



SEAL Delivery Vehicle

### *Dry Deck Shelter (DDS)*

The DDS allows for the launch and recovery of an SDV or combat rubber raiding craft (CRRC) with personnel from a submerged submarine. The DDS consists of three modules constructed as an integral unit. The first module is a hangar in which an SDV or CRRC is stowed. The second module is a transfer trunk to allow passage between the modules and the submarine. The

third module is a hyperbaric recompression chamber. The DDS provides a dry working environment for mission preparations. In a typical operation the DDS hangar module will be flooded, pressurized to the surrounding sea pressure, and a large door opened to allow for launch and recovery of the vehicle. A DDS can be transported by USAF C-5/C-17 aircraft, rail, highway, or sealift.

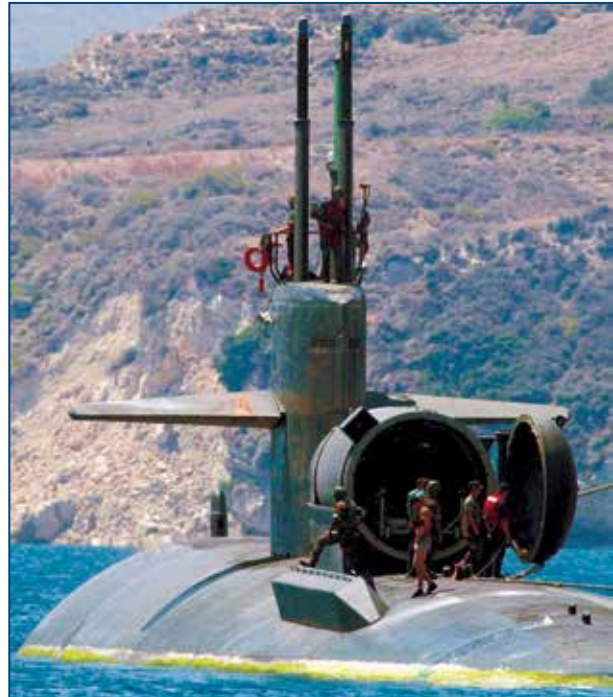

Dry Deck Shelter on a Submarine Deck

### *Design Characteristics*

Length:	39 feet
Width:	10 feet
Weight:	65,000 pounds
Volume:	3,705 cubic feet

# Chapter 5. U.S. Air Force Special Operations Forces

## Air Force Special Operations Command (AFSOC)

**A**FSOC is an Air Force major command and constitutes the air component of USSOCOM. AFSOC is organized into three active-duty wings, one reserve wing, one National Guard wing, one active-duty overseas group, one active-duty overseas wing, the Air Force Special Operations Air Warfare Center, and several direct reporting units.

AFSOC forces are apportioned and assigned by the Secretary of Defense to USSOCOM. All SOF are under the combatant command of CDRUSSOCOM. Operational control of overseas SOF is exercised by the



GCCs through the TSOC commanders. Only USPACOM and USEUCOM have theater-assigned AFSOC forces.

### *AFSOC Mission*

AFSOC's mission is to organize, train, and equip Airmen to execute global special operations. The command is committed to continual improvement to provide AFSOF for worldwide deployment and assignment to regional unified commands, conducting and supporting the full spectrum of special operations.

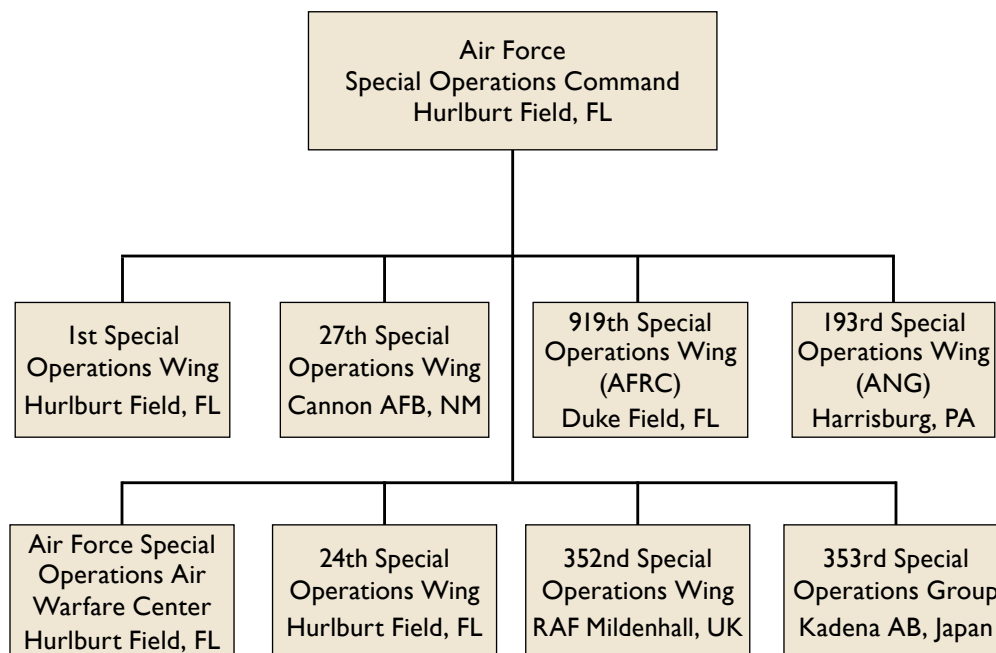

Figure 5-1. Air Force Special Operations Command



## Air Force Special Operations

The United States is engaged in protracted operations that will persist for the foreseeable future. AFSOF are at the forefront of these operations. In recent years, the U.S. has called upon AFSOF to deliver unique capabilities and skill sets to combatant commanders across the range of military operations, from disaster response (such as those in Haiti and Japan) to major operations and campaigns (Iraq and Afghanistan).

Special operations are typically conducted in hostile, denied, or politically sensitive environments to achieve military, diplomatic, informational, and/or economic objectives employing military capabilities for which there is no broad conventional force requirement. AFSOC planning must consider joint support, coordination, synchronization, and integration issues. Ultimately, the most important elements of the Air Force's special operations capabilities reside in its aircrews, special tactics teams, combat aviation advisory teams, and support personnel who are specially trained to conduct the following eight AFSOC core mission areas across the range of military operations:

- a. Agile combat support
- b. Aviation foreign internal defense
- c. Special tactics
- d. Command and control
- e. Precision strike
- f. Information operations
- g. Intelligence, surveillance, reconnaissance
- h. Specialized air mobility

Future AFSOF must prepare for a complex strategic environment characterized by an extended period of uncertainty, persistent conflict, and shifting global power bases that will present a broad range of state and non-state adversaries. To better prepare to execute its core missions in this environment, AFSOF must possess an understanding of the projected future operating environment and the implications to AFSOF that must operate therein. Comprehending these challenges and implications will enable AFSOC to focus its strategy development and supporting planning and programming activities to ensure it invests in the right force, properly prepared to execute the full range of Air Force special operations core missions in an increasingly

complex world. Within the projected future operating environment, AFSOF will be tasked to operate in three environments:

- a. **Persistent Engagement.** Predominantly, AFSOF will be called upon to conduct operations on a global and continuing basis. AFSOF also employ the full range of AFSOF core missions with an emphasis on aviation FID; assess, train, advise, and assist activities; and stability operations, both to meet emerging challenges and to gain strategic access and shape operational conditions.
- b. **Crisis Response.** Concurrently, AFSOF will need to maintain the ability to employ forces around the globe with an emphasis on specialized mobility, strike, ISR, other traditional Air Commando activities, and humanitarian assistance/disaster relief functions as directed. These capabilities will establish safe and secure environments and assist HNs in providing essential services to their populations, managing critical infrastructure, and enhancing governance.
- c. **Major Operations and Campaigns.** Even if the likelihood of MCO decreases in the future operating environment, AFSOF must continue to maintain the ability to support joint SOF global combat power projection and sustainment at strategic distances, effectively conduct urban operations, and penetrate and operate within anti-access and area-denial airspace.

## AFSOC Employment

Air Force SOF employ uniquely equipped aircraft that are operated by highly trained aircrews to conduct precision strike, mobility, ISR, and IO missions. Operations may include manned and remotely piloted aircraft.

For SOF mobility infiltration missions, tilt-rotor aircraft are normally preferred over airdrop to minimize injuries and reassembly problems. Air refueling of AFSOC vertical-lift aircraft may be necessary to extend range and minimize the security and logistics problems associated with forward area ground refueling.

### Threats

AFSOC's primary method of dealing with the threat is to use detection avoidance navigation, threat avoidance navigation (DANTAN). Low-level operations and the cover of night are the primary employment concepts used to avoid detection and threats. Extensive planning to avoid enemy radar, air defenses, and populated areas is required. Minimum lighting/lights out, communications out/radio discipline, low probability of intercept/detection (LPI/D) radios, and deceptive course changes are also used to achieve mission objectives. AFSOC uses passive warning systems and procedures to assist in avoiding detection and threats, and countermeasures and evasive maneuvering when engaged.

### Capabilities

AFSOC crews and aircraft can conduct clandestine penetration of hostile, sensitive, or politically denied airspace. They can navigate precisely along planned routes to points or targets within narrow time parameters, in conditions of minimum visibility (darkness and/or adverse weather). Fixed-wing aircraft used for airland operations can use minimum length, unimproved landing strips. Terrain following and terrain avoidance systems and procedures are employed. AFSOC's capabilities include:

- a. Clandestine or covert penetration of hostile, sensitive, or politically denied airspace
- b. Infiltration, exfiltration, and resupply using airland, airdrop, and alternate insertion and extraction methods
- c. Organic tanker air refueling of tilt-rotor and vertical-lift platforms
- d. Strategic tanker in-flight refueling of organic fixed-wing/tilt-rotor aircraft
- e. Precision munitions employment against static and moving targets
- f. Controlling air traffic, establishing air assault landing zones, directing close air support for strike aircraft and gunship missions, taking weather observations, supporting personnel recovery, and providing advanced trauma care
- g. Synchronize and integrate sensors and assets to process, exploit, and disseminate intelligence in support of current and future operations
- h. Advising, training, or assisting foreign nation air forces to support U.S. and coalition interests in support of HN internal defense and development strategy
- i. Electronic broadcasting for MISO in standard AM/FM radio, television, short wave, and military communications frequency bands; in addition, select SOF aircraft may be employed in MISO roles supporting either special or conventional operations
- j. Providing command and control for special operations



Special Tactics personnel gear up for night firing and firing movements in March 2003 at an undisclosed location in support of Operation Enduring Freedom.

### Planning Considerations

Mission planning for penetration and overflight of hostile territory must be thorough and complete. Detailed planning includes terrain, weather, cultural features, population, and air and ground enemy air defenses. Operations security (OPSEC) and communications

security (COMSEC) are imperative for both mission planning and execution.

Mission planning support requirements are usually extensive. All joint special operations activities must be closely coordinated. Mission tasking details must be provided sufficiently in advance to allow adequate mission planning time. During tactical airdrop operations, air commanders are responsible for air safety, and ground commanders are responsible for ground safety. Close coordination is required to ensure understanding and consensus on the concept of operations. Tactical deception must be considered during planning for all special operations missions.

Inherent operational limitations of most SOF normally precludes rapid commitment to support conventional military operations. Planners must be familiar with the limitations defined in the appropriate technical manuals/orders and volumes of Air Force Tactics, Techniques, and Procedures (AFTTP) 3-1 (S) for AFSOC aircraft. AFSOF operate most effectively in particular environments and under specific methods of

employment. As a general rule, AFSOF become less effective when employed outside their intended operational environments. For example, infiltration, exfiltration, and resupply aircraft may be less effective in conditions other than darkness and adverse weather. General limitations that apply to all AFSOF may include:

- a. Limited self-deployment and sustainment capability
- b. Dependence on established support and logistics packages that must accompany employment aircraft
- c. Technological sophistication of most AFSOF resources affects bed-down requirements, bare base operations, and requires extensive maintenance support
- d. Long-range deployment and employment require inflight refueling (strategic) and air refueling (AFSOC tanker, vertical-lift receiver)
- e. Limited air-to-air defensive capabilities

## Aircraft and Unique Capabilities Summary

### *AC-130U Spooky*

The AC-130 is a C-130 modified with gun systems, electronic and electro-optical sensors, fire control systems, enhanced navigation systems, sophisticated communications, defensive systems, and inflight refueling capability. Additionally, the AC-130 can receive Predator UA video to find and fix targets, allowing the AC-130 to “stand off” in a safer environment until the target is identified by the Predator. These systems give the gunship crew the capability to acquire and identify targets day or night, coordinate with ground forces and command and control agencies, and deliver surgically precise firepower in support of both conventional and special operations missions. The gunship is best suited for the CAS mission and has a unique capability to deliver ordnance in extremely close proximity to friendly forces in a TIC situation. Gunships can also perform interdiction and armed reconnaissance missions, particularly where limited collateral damage is required. The aging AC-130U gunships will eventually be replaced by the AC-130J.

### *AC-130W Stinger II*

The primary mission of the AC-130W Stinger II is close air support. The Stinger is modified with gun systems, precision guided munitions, small diameter bombs, a robust communications suite, and inflight refueling capability. In addition to strike capabilities, the Stinger is capable of transmitting and receiving video from multiple platforms. This allows for near real-time execution of the find, fix, track, target, engage, and assess (F2T2EA) process, either day or night, with surgical precision in both conventional and special operations arenas. The Stinger is also capable of executing strike, coordination, and reconnaissance, and air interdiction type missions due to the standoff capability of the weapons load. The AC-130W will eventually be recapitalized by the AC-130J.

### *MC-130H Combat Talon II*

The Combat Talon II supports a range of activities from crisis response to wartime commitment in special

operations missions. These missions include day and night infiltration, exfiltration, resupply, aerial refueling of specially modified helicopters and tilt-rotor aircraft, MISO, and forward area refueling point (FARP) operations in hostile and denied territory using airland or airdrop procedures. Combat Talons are capable of inflight refueling, giving them extended range. Combat Talon missions may be accomplished by either single-ship or formation, or in concert with other special operations assets in varying multi-aircraft scenarios. Combat Talons employ terrain-following and terrain-avoidance radars and a robust infrared and electronic countermeasures suite to facilitate the airland and airdrop personnel and equipment on austere, marked, and unmarked landing/drop zones, day or night, in adverse weather. These aircraft can conduct overt, clandestine, and low-visibility operations. They can be employed in a low- to medium-threat environment.

### *MC-130J Commando II*

The Commando II supports a range of activities from crisis response to wartime commitment in special operations missions. These missions include day and night infiltration, exfiltration, resupply, aerial refueling of specially modified helicopters and tilt-rotor aircraft, MISO, and FARP operations in denied territory using airland or airdrop procedures. Commando II aircraft are capable of inflight refueling, giving them extended range. Commando II missions may be accomplished either in single-ship or formation, or in concert with other special operations assets in varying multi-aircraft scenarios to facilitate the airland and airdrop of personnel and equipment on austere, marked, and unmarked landing/drop zones, day or night, in adverse weather. These aircraft can conduct overt, clandestine, and low-visibility operations. They can be employed in a low- to medium-threat environment.

### *CV-22 Osprey*

The CV-22 Osprey is a tilt-rotor platform. It can self-deploy immediately to the AO, eliminating dependence on strategic airlift and additional time to tear down and

build up vertical-lift assets. It has a VTOL capability, speed comparable to an MC-130, double the unrefueled range of an MH-53M, and requires less aerial refueling tanker support than existing SOF helicopters. The CV-22 also has improved survivability, reliability, maintainability, and reduced weapon system support force structure. The CV-22 is designed for penetrating denied airspace and conducting infiltration, personnel recovery, exfiltration, and resupply missions.

### ***EC-130J Commando Solo***

Commando Solo is an airborne electronic broadcasting system. The 193 SOW, Pennsylvania Air National Guard, based at Harrisburg International Airport, Middletown, Pennsylvania, operates the EC-130J Commando Solo aircraft. Its mission is to conduct MISO broadcasting in frequencies including the standard AM/FM radio, television, short-wave, and military communications bands. This system may also be used to:

- a. Support disaster assistance efforts by broadcasting public information and instruction for evacuation operations
- b. Provide a temporary replacement for existing transmitters or expand their areas of coverage
- c. Meet other requirements that involve radio and television broadcasting in its frequency range

The EC-130J is capable of limited special operations mobility missions.

### ***C-145A Combat Coyote***

The C-145A is the U.S. Air Force designation for the PZL M-28 Skytruck commercial variant, utility aircraft that provides intra-theater support for SOF. The M-28 was selected for its versatile performance characteristics and ability to operate from short and unimproved runway surfaces.

### ***C-146A Wolfhound***

The C-146A is the U.S. Air Force designation for the Dornier Do-328 utility aircraft that provides inter- and intra-theater support for SOF. This regional turbo-prop can operate from shorter runways than a C-130 and

can carry up to 32 passengers or a payload of up to 8,135 pounds.

### ***U-28A***

The U-28A is the Air Force variant of the Pilatus PC-12 and was selected for its versatile performance characteristics and ability to operate from short and unimproved runway surfaces.

### ***MQ-1B Predator***

The MQ-1 Predator, flown by 3rd Special Operations Squadron, is a medium-altitude, long-endurance, remotely piloted aircraft with associated personnel and equipment. The MQ-1's primary mission is armed ISR in support of COIN/CT missions against critical, perishable targets.

### ***MQ-9 Reaper***

The MQ-9 Reaper, flown by 2nd, 3rd, and 33rd Special Operations Squadrons, is a medium-to high-altitude, long-endurance, remotely piloted aircraft. The MQ-9's primary mission is find, fix, finish, exploit, and assess (F3EA) emerging targets in support of COIN/CT missions. The MQ-9's alternate mission is as an intelligence, surveillance and reconnaissance asset, with sensors to provide real-time data.

### ***Special Tactics (ST)***

The 24th Special Operations Wing (SOW) comprises Air Force combat control, pararescue, and special operations weather personnel capable of providing terminal control, reconnaissance, and recovery. ST core competencies include austere airfield control; environmental reconnaissance/objective area weather forecasting; terminal attack control/fire support operations; personnel rescue and recovery; battlefield trauma care; and assault zone assessment, establishment, and control. In addition, 24 SOW includes specialized support in the fields of intelligence, life support, logistics, weapons, supply, medical logistics, vehicle maintenance, and radio maintenance. These are highly skilled individuals who are technical experts and worldwide deployable to support any type of contingency across the spectrum.



Just one week after a magnitude-7.0 earthquake struck Port-au-Prince, Haiti, on 12 January 2010, a combat controller from the 21st Special Tactics Squadron assesses a potential drop zone for relief supplies during Operation Unified Response.

### ***Combat Aviation Advisors (CAA)***

Combat Aviation Advisors are carefully selected and specially trained to provide U.S. military expertise to foreign country governments worldwide, supporting U.S. and coalition interests in support of HN internal defense and development efforts.

### ***Augmenting USAF Forces***

Although not core AFSOF, certain conventional forces are specially trained, equipped, and organized to conduct missions in support of special operations. This support is provided on a non-dedicated, mission-specific basis. These forces do not conduct unilateral special operations activities, but provide specific requirements supporting AFSOF.

Depending upon the mission, the President, SecDef, or geographic combatant commander may allocate any DOD assets to support special operations, depending

upon the capabilities required. This support is usually mission-specific and of short duration. Such capabilities may include strategic or tactical bombing or airlift, airborne warning and control, electronic warfare, reconnaissance, deception, space-based, or cyberspace support.

### ***Special Operations Low-Level (SOLL)***

Fixed-wing strategic and tactical airlift capability that can quickly augment AFSOF for the conduct and support of selected special operations as the result of special aircrew training and/or aircraft modification.

### ***Rescue effort***

Tactical aircraft may be used to support personnel recovery operations in a rescue escort role.

### *Strategic tankers*

USAF maintains a limited number of strategic tanker crews trained to support the unique refueling requirements of AFSOF fixed-wing aircraft.

### *17th Special Tactics Squadron (STS), Fort Benning, Georgia*

The 17 STS is tasked with supporting the Ranger Regiment as well as Special Operations Tactical Air Control Party (SOF TACP) support of USASOC's 1st, 3rd, 5th, 7th, 10th SFGs, and the John F. Kennedy Special Warfare Center and School. 17 STS advises on the capabilities and use of tactical air power and assists in the planning and employment of tactical air support. SOF TACPs also provide the communications link with the Theater Air Control System, conduct emergency CAS/terminal guidance operations and training, and provide CAS control for exercises and contingencies.

## AFSOC Active Duty Wings and Groups

**A**FSOC special operations wings (SOWs), groups (SOGs) and squadrons are numbered in accordance with USAF mission heritage and lineage. The three active duty wings are commanded by colonels (O-6), two who also serve as installation commanders. AFSOC active-duty wings are commanded by a colonel (O-6), with staff support agencies.

AFSOC currently maintains three active duty CONUS wings (1 SOW, 24 SOW, and 27 SOW) one Air Reserve Wing (919 SOW), and one Air National Guard Wing (193 SOW). The standard Air Force wing consists of four groups; an operations group, a maintenance group, a medical group, and a mission support group. AFSOC operations groups consist of squadrons, commanded by lieutenant colonels, that operate a specific weapon system. Each maintenance group consists of maintenance squadrons that are sister units to each of the operational squadrons and provide maintenance support to the weapons systems operated by the operational squadrons. Each medical group consist of medical, aerospace medicine squadrons, dental squadrons, and installation clinics.

Each mission support group is made up of squadrons with specialized services or activities: civil engineering, communications, contracting (SOCONS), logistics

readiness, force support, security forces, and operations support squadrons.

The two overseas special operations groups, the 352 SOW, and 353 SOG are organized to operate as integrated combat units and are assigned to their respective Theater Special Operations Commands.

### 1st Special Operations Wing (1 SOW)

The 1 SOW is located at Hurlburt Field and is the oldest and most seasoned unit in AFSOC.

#### Mission

The 1 SOW mission is to organize, train, and equip Airmen to execute global special operations.



#### Organization

The 1 SOW is AFSOC's largest unit. It deploys with specially trained and equipped forces from each service, working as a team to support national security objectives. The 1 SOW manages a fleet of more than 90 aircraft with a military and civilian work force of nearly 10,000 people. It includes the units depicted in Figure 5-2.

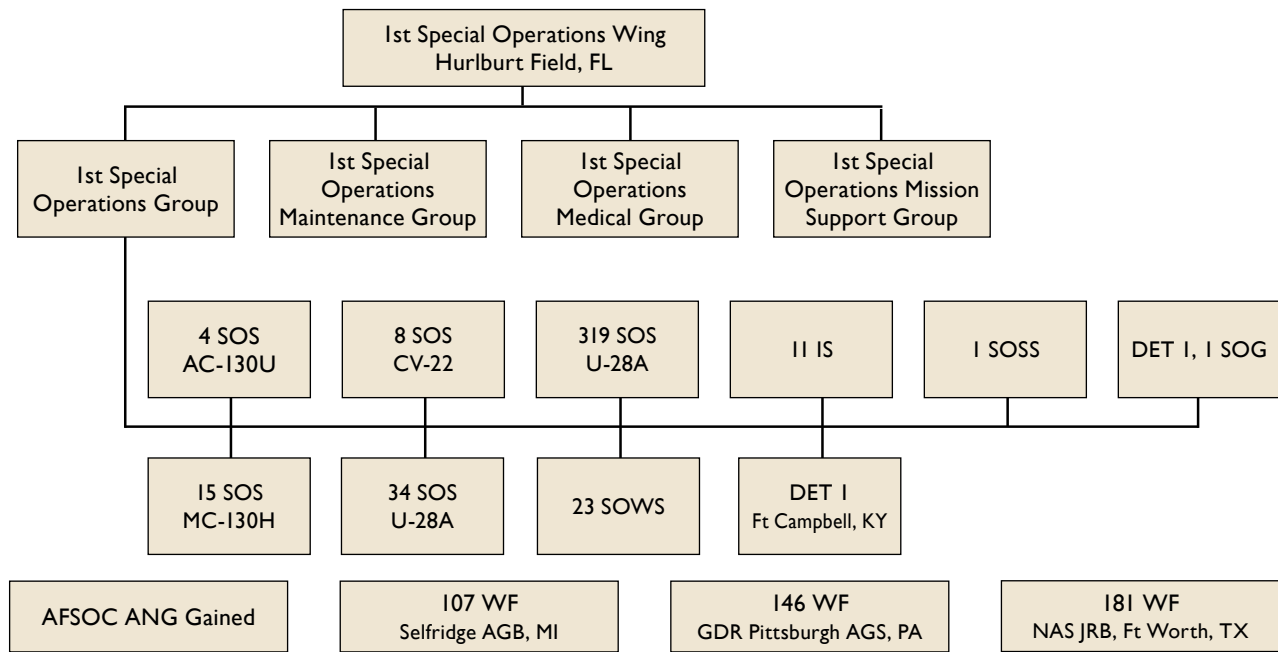

Figure 5-2. 1st Special Operations Wing



### 24th Special Operations Wing (24 SOW)

The 24th Special Operations Wing is one of three Air Force active duty special operations wings assigned to Headquarters Air Force Special Operations Command and was established in June 2012. The 24 SOW is based at Hurlburt Field and includes the units depicted in Figure 5-3.



#### Mission

The primary mission of the 24 SOW is to provide Special Tactics forces for rapid global employment to enable airpower success. The 24 SOW is USSOCOM's tactical air/ground integration force and the Air Force's special operations ground force to enable global access, precision strike and personnel recovery operations.

Core capabilities encompass: airfield reconnaissance, assessment, and control; personnel recovery (PR); joint terminal attack control (JTAC); and environmental reconnaissance. Special Tactics is composed of Special Tactics Officers (STO), Combat Controllers (CCT), Combat Rescue Officers (CRO), Pararescuemen (PJ), Special Operations Weather Officers and Airmen (SOWT), Air Liaison Officers (ALO), Tactical Air Control Party (TACP) operators, and a number of combat support Airmen, which compose 58 Air Force specialties.

These unique skills provide a full-spectrum, air-focused special operations capability to the combatant commander in order to ensure airpower success. With their unique skill sets, Special Tactics operators are often the first special operations elements deployed into crisis situations.

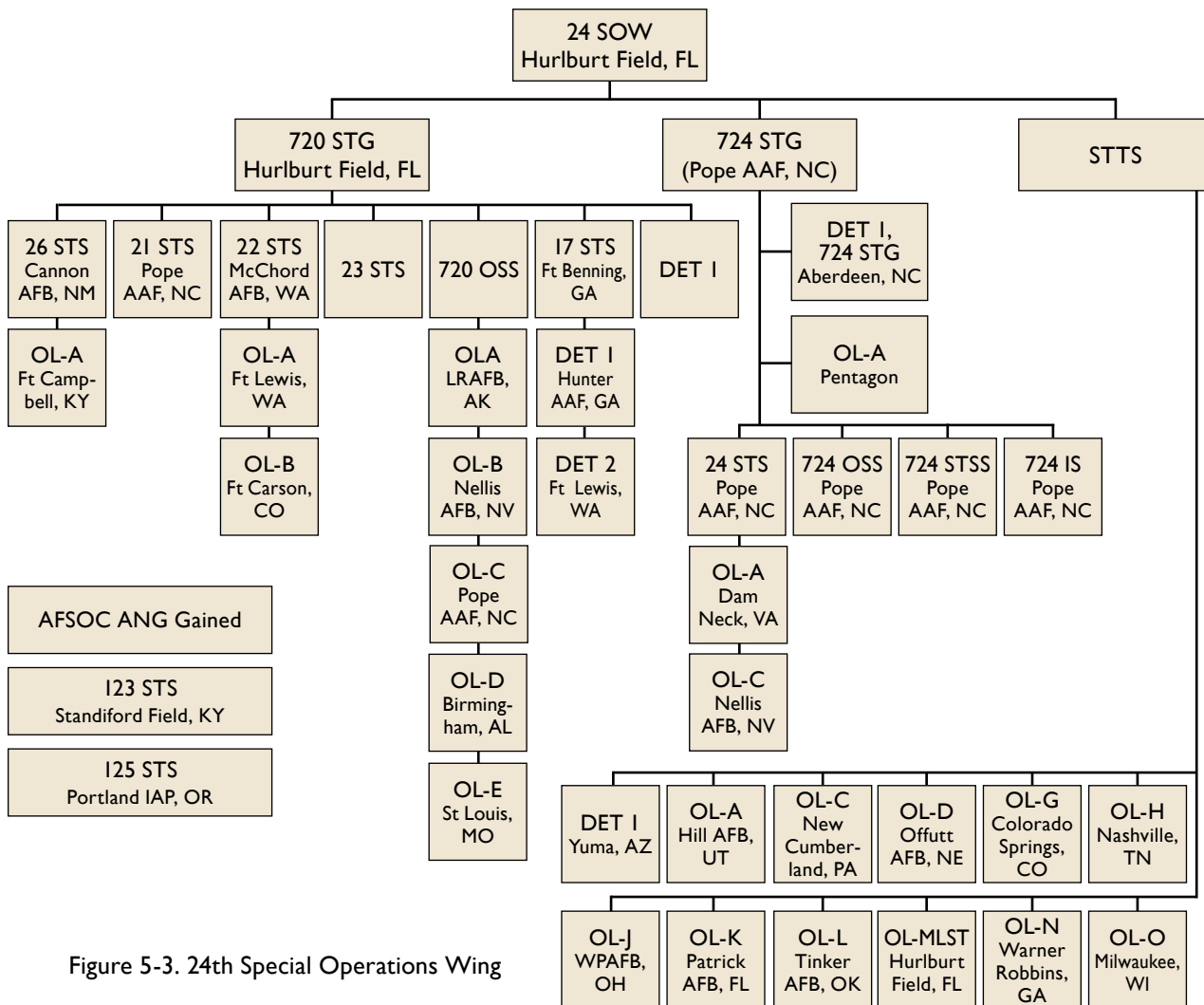

Figure 5-3. 24th Special Operations Wing

**Organization**

The 24 SOW has two operational groups, the 720th Special Tactics Group (STG) at Hurlburt Field and the 724 STG at Pope Field, North Carolina, one special tactics training squadron, and multiple special operations recruiting liaison operating locations. The 320 STS at Kadena AB, Japan, and the 321 STS at RAF Mildenhall, England, are assigned to and under the operational control of the 353 SOG and 352 SOW, respectively. The 123rd Special Tactics Squadron based at Standiford Field, Kentucky, and the 125th Special Tactics Squadron based at Portland International Airport, Oregon, are Air National Guard gained units that augment the 24 SOW in support of national security objectives, combat operations, humanitarian efforts and training.

**27th Special Operations Wing (27 SOW)**

The 27 SOW is located at Cannon AFB, New Mexico, and includes the units depicted in Figure 5-4.



**Mission**

The 27 SOW's mission is to plan and execute specialized and contingency operations using advanced aircraft, tactics, and air refueling techniques to infiltrate, exfiltrate, and resupply SOF and to provide intelligence, surveillance and reconnaissance, and CAS in support of SOF operations.

**352nd Special Operations Wing (352 SOW)**

The 352 SOW at RAF Mildenhall, United Kingdom, is the designated Air Force component for SOCEUR.

**Mission**

The mission of the 352 SOW is to act as the focal point for all USAF special operations activities throughout the European Command AOR. The group is prepared to conduct a variety of high-priority, low-visibility missions supporting U.S. and allied SOF throughout the European theater during peacetime, joint operations exercises, and combat operations. The 352 SOW develops

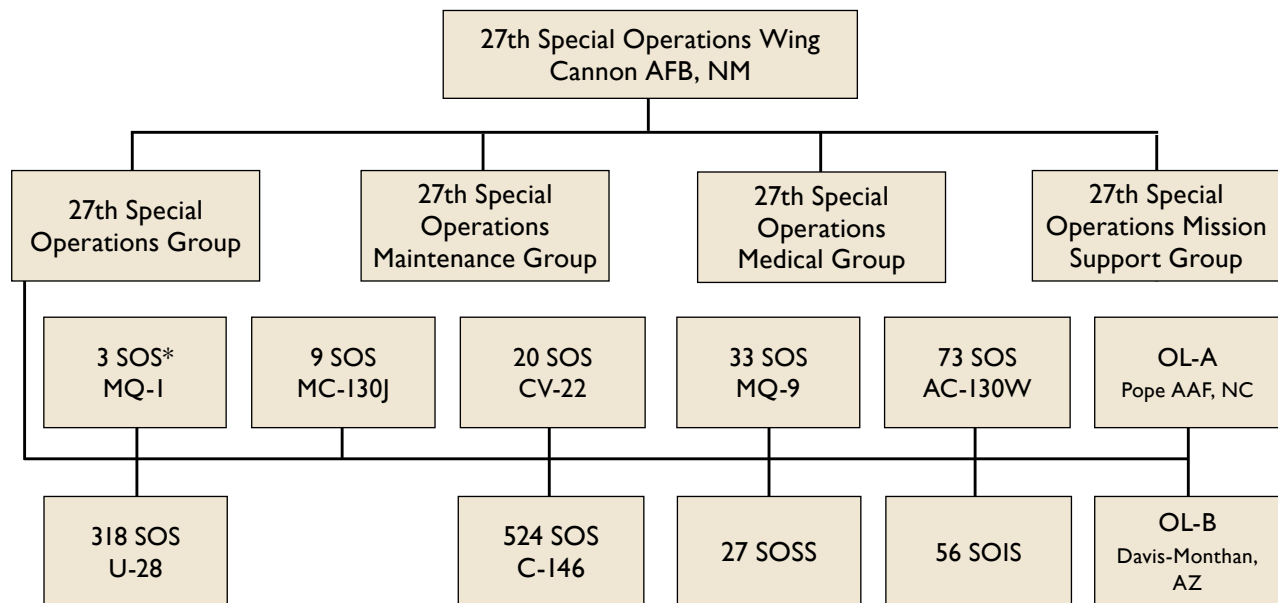

\*3 SOS is Classic Associate with 919 SOWs 2 SOS

Figure 5-4. 27th Special Operations Wing

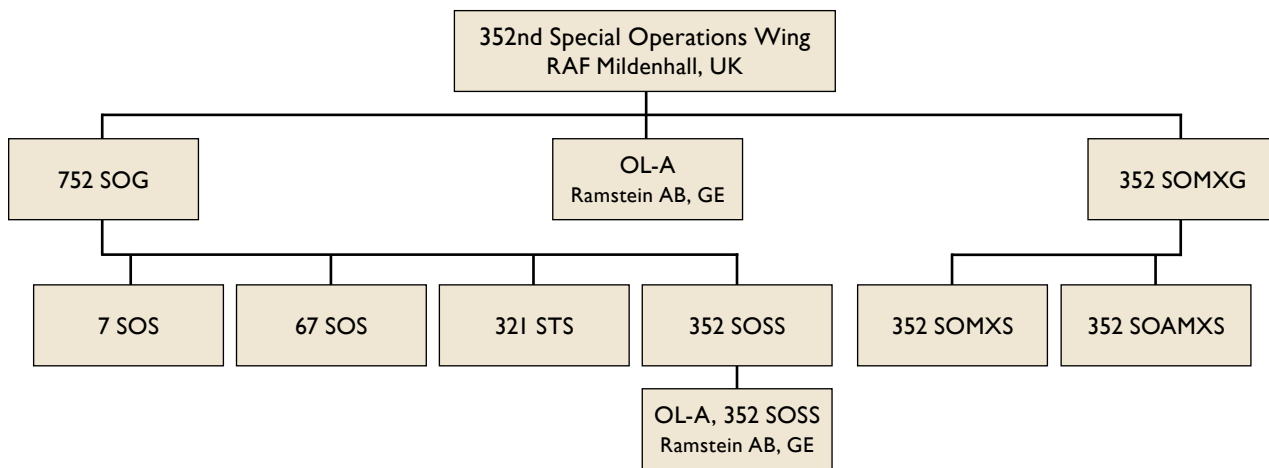

Figure 5-5. 352nd Special Operations Wing

and executes peacetime and wartime contingency plans to effectively use fixed-wing, tilt-rotor, and personnel assets to conduct infiltration, exfiltration, and resupply of U.S. and allied SOF.

**Organization**

The 352 SOW is the Air Force component for SOCEUR, a sub-unified command of the U.S. European Command. The 352 SOW has two flying squadrons, a special tactics squadron, a special operations support squadron, and two maintenance squadrons. It includes the units depicted in Figure 5-5.

**353rd Special Operations Group (353 SOG)**

The 353 SOG, headquartered at Kadena Air Base, Japan, is the Air Force component for SOCPAC.



**Mission**

The group’s mission is to act as the focal point for all USAF special operations activities throughout the Pacific. The group is prepared to conduct a variety of high-priority, low-visibility air support missions for joint and allied SOF in the region. It maintains a worldwide mobility commitment, participates in theater exercises, and supports humanitarian assistance and disaster relief operations. The group develops wartime and contingency plans to effectively use the full range of fixed-wing capabilities, to include infiltration, exfiltration, and resupply of U.S. and allied SOF. The

primary peacetime responsibility of the 353 SOG is to oversee the training and maintenance of its assigned units. The group ensures the combat readiness of these units through comprehensive involvement in numerous theater and Joint Chiefs of Staff-directed military exercises and training activities throughout the Pacific.

**Organization**

The 353 SOG comprises the USAF special operations air arm in USPACOM. The commander is designated Commander, Air Force Special Operations Command, Pacific, which is a sub-unified command to the Special Operations Command, Pacific. The 353 SOG has two flying squadrons, a maintenance squadron, a support squadron, and a special tactics squadron. It includes the units shown in Figure 5-6.

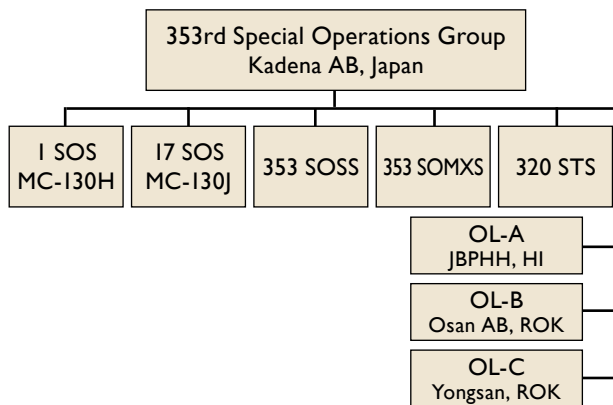

Figure 5-6. 353rd Special Operations Group

## Air Reserve and Air National Guard Components

**A**FSOC gains three Air Reserve Component units when they are mobilized. One is the 919 SOW, Air Force Reserve Command (AFRC) at Duke Field, Florida. Its 711 SOS employs Combat Aviation Advisors (CAA) to partner nations to conduct aviation FID missions. The second is the 193 SOW, Air National Guard (ANG,) at Harrisburg International Airport, Pennsylvania, which flies the EC-130J Commando Solo. The third component is the 123/125 Special Tactics Squadrons of the ANG.

### 919th Special Operations Wing (919 SOW) (AFRC)

The 919 SOW at Duke Field is the only Air Force Reserve Command special operations wing. When mobilized, it reports to AFSOC.

The 919 SOW provides C-145A, U-28A and MQ-9 aircraft operations, maintenance, and support functions to accomplish special operations and trains active duty crew members to fly the U-28A. The 919 SOW reports to the Air Force Reserve's 10th Air Force at Carswell AFB, Texas. The 919 SOW has more than 1,400 reservists and full-time civilian employees assigned. It includes the 5 SOS and the 711 SOS.

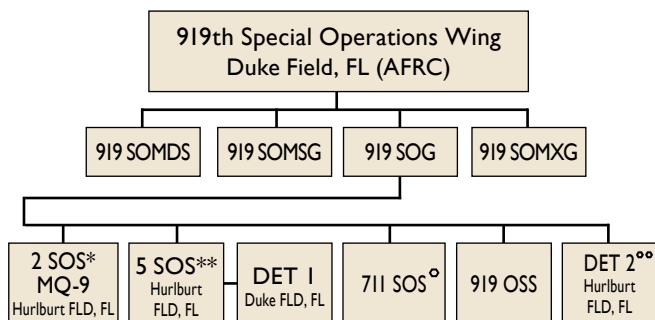

\*2 SOS is Classic Associate with 27 SOWs 3 SOS  
 \*\*5 SOS is Classic Associate with AFSAOWC 19 SOS  
 °711 SOS is Classic Associate with 1 SOW 6 SOS  
 °°DET 2 is Classic Associate with AFSOC OC

Figure 5-7. 919th Special Operations Wing

### 193rd Special Operations Wing (193 SOW) (ANG)

The 193 SOW, Pennsylvania ANG, Harrisburg International Airport, is the Air Force's sole asset for providing airborne radio and television broadcast missions. This Guard unit falls under AFSOC

when mobilized for wartime action, humanitarian efforts or contingencies. The 193 SOW provides an airborne platform for virtually any contingency, including state or national disasters, or other emergencies, on a moment's notice, anywhere in the world. The 193 SOW performs this unique mission with specially configured EC-130J Commando Solo aircraft. Secondary 193 SOW missions include limited special operations mobility capabilities, airlift for Air Force Intelligence Agency missions, and to provide airborne command and control for special operations.

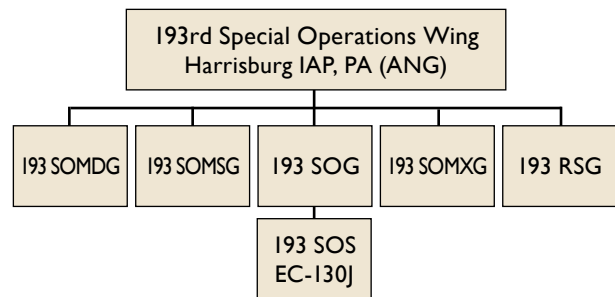

Figure 5-8. 193d Special Operations Wing

### 123rd Special Tactics Squadron, Kentucky Air National Guard

Located at Louisville, Kentucky, the 123 STS falls under AFSOC when mobilized for wartime action, humanitarian efforts, or contingencies. The 123 STS trains, equips, and employs combat control, pararescue, special operations weathermen, and support personnel in response to Presidential/SecDef taskings. Their primary task is to integrate, synchronize, and/or control the elements of air and space power in the objective area. The 123 STS performs austere airfield control, terminal attack control, personnel rescue and recovery, assault zone assessment, battlefield trauma care, direct action, and special reconnaissance.

### ***125th Special Tactics Squadron, Oregon Air National Guard***

Located at Portland, Oregon, the 125 STS falls under AFSOC when mobilized for wartime action, humanitarian efforts or contingencies. The 125 STS trains, equips and employs combat control and support personnel in response to Presidential/SecDef taskings. Its primary task is to integrate, synchronize, and/or control the elements of air and space power in the objective area. The 125 STS performs austere airfield control, terminal attack control, personnel rescue and recovery, assault zone assessment, direct action, and special reconnaissance.

### ***150th Special Operations Flight***

The 150th Special Operations Flight at Joint Base McGuire-Dix-Lakehurst, New Jersey, provides modified C-32B aircraft supporting worldwide airlift operations.

### ***107th, 146th, and 181st Weather Flights***

The 107th Weather Flight at Selfridge Air National Guard Base, Michigan; 146th Weather Flight at GTR Pittsburgh Air Guard Station, Pennsylvania; and the 181st Weather Flight at Dallas Naval Air Station, Texas, are the command's three National Guard weather units.

### ***209th Special Operations Civil Engineer Squadron***

The 209th Special Operations Civil Engineer Squadron located at Gulfport, Mississippi, is AFSOC's only Guard civil engineer squadron supporting the command's transportable collective protection system mission.

### ***280th Combat Communications Squadron***

The 280th Combat Communications Squadron at Dothan, Alabama, is AFSOC's only Guard communications squadron.

## Air Force Special Operations Forces Logistics

**A**FSOF logistics is primarily focused on creating, preparing, deploying, employing, sustaining, and protecting the specialized air operations mission through the full range of military operations. Logistics and maintenance emphasize the launch, recovery, service, rapid repair, and relaunch cycle. The turn-around cycle may be compressed into relatively short periods of 12 hours or less. This places a significant burden on the logistics infrastructure, given the level of sophistication of SOF aircraft modifications and the requirement to operate from austere locations. Additionally, AFSOF logistics may be required to provide initial contingency base operating support in support of special operations.

The parent organizations—wing, group and/or squadron—are responsible for determining equipment, spares, and personnel requirements. Total requirements determination will be based on the deployment duration and the extent of existing logistics and base operating support at the deployed location. Once deployed, the AFSOF logistics readiness officer will manage and coordinate logistics support, including but not limited to supply and contracting support, communications, vehicle, fuels, billeting, and messing requirements, and will establish connectivity with the theater and CONUS logistic support systems.

Should time permit prior to deployment, the wing or group logistic planning cell will develop a plan to support deployed air operations and concomitant logistics objectives. AFSOC units normally tailor their contingency support packages to accommodate the mission options for self-deployment, limited airlift deployments, and, when applicable, shipboard operations. Employment of 30 days or less normally will be supported by mobility readiness spares packages and limited base operating support. Intermediate level maintenance support may be deployed to collocate with AFSOF or be centrally located to support SOF as well as theater operations. While AFSOC units are en route or at an austere location, the AFSOF Logistics Readiness Center (LRC) is the primary supply support medium for non-mission-capable supply (NMCS) spares requests and orchestrates the acquisition-to-delivery process. Long-term employments will be supported by established supply pipelines

with the exception of NMCS conditions which will be accomplished by the LRC. SOF-unique requests may go through the SOJTF/JSOTF/SOC J4 to USSOCOM Special Operations Acquisition and Logistics Center (J4) or directly to the Special Operation Forces Support Activity.

From an Air Force logistics perspective, support squadrons are organic to the 1 SOW, the 27 SOW and the two OCONUS SOGs. They deploy, in part, whenever elements of the parent wing or group deploy. The 1st and 27th Special Operations Mission Support Groups, composed of qualified personnel from a composite of support squadrons, provide the primary logistics support for CONUS-based AFSOF. The OCONUS special operations groups provide the primary logistic support of OCONUS-based AFSOF. They accomplish their mission by meeting the following key objectives: maintaining personnel, equipment and supplies in constant state of deployment and combat readiness; providing world-class training to logistics and maintenance personnel; and striving for technological superiority, robustness, agility, and full integration with joint operations.

## AFSOC Aircraft and Capabilities

### AC-130U Spooky Gunship

#### Overview

The AC-130U Spooky Gunship is a heavily armed aircraft that has side-firing weapons integrated with sophisticated sensor, navigation, and fire control systems to provide accurate firepower during extended loiter periods, at night, and in adverse weather.

#### Mission Sets

The AC-130U Spooky Gunship is a C-130 modified with gun systems, electronic and electro optical sensors, fire control systems, enhanced navigation systems, sophisticated communications, defensive systems, and inflight refueling capability. These systems give the gunship crew the capability to acquire and identify targets day or night, coordinate with ground forces and command and control agencies, and deliver accurate firepower in support of both conventional and SOF missions. The gunship's primary missions are close air support (CAS) and interdiction. The gunship is particularly well suited for the CAS mission and has a unique capability to deliver ordnance in extremely close proximity to friendly forces in a troops-in-contact (TIC) situation. Gunships can also perform interdiction and armed reconnaissance missions, particularly where limited collateral damage is required. The gunship can be employed in low- to medium-threat environments.

Table 5-1. AC-130U General Information

AC-130U Spooky	
Length	97 ft., 9 in. (30.4m)
Height	38 ft., 6 in. (11.7m)
Wingspan	132 ft., 7 in. (40.4m)
Speed	250 KTAS, cruise 300 mph (at sea level)
Weapons	105mm, 40mm, & 25mm
Max Takeoff Weight	155,000 pounds (69,750 kg), 175,000 pounds with waiver
Range	1,200 nm, unlimited with air refueling
Crew	13: 2 pilots, 1 flight engineer, 2 sensor operators, 1 navigator, 1 FCO, 1 EWO, 4 gunners, 1 loadmaster

#### Equipment Characteristics and Specifications

The AC-130U "Spooky" is a highly-modified C-130 with 25mm GAU-12 cannon, 40mm M2A1, and a 105mm M137A1 cannon gun systems. The Spooky is also equipped with an infrared pointer and laser target designator/ranger. The AC-130U also comes equipped with an infrared detection set/system (IDS), multi-spectral television (MTV), APQ-180 strike radar, IR and electronic countermeasures. Fire control systems, enhanced navigation systems, sophisticated communi-



AC-130U Spooky Gunship

ications, defensive systems, and inflight refueling capability round out the SOF unique equipment onboard an AC-130U Spooky. These systems give the gunship crew the capability to acquire and identify targets day or night, coordinate with ground forces and command and control agencies, and deliver accurate firepower.

#### Additional Information

AFTTP 3-3.AC-130 Combat Fundamentals (Note: Reference is FOUO)

AFTTP 3-1.AC-130 Tactical Employment (Note: Reference is classified)

### AC-130W Stinger II

#### Overview

The AC-130W Stinger II is a heavily armed aircraft that has a side-firing 30mm weapon integrated with sophisticated sensor, navigation, threat detection and

countermeasures, and communication suites. The AC-130W is also capable of employing a variety of precision-guided munitions (PGM) to include the GBU-39 Small Diameter Bomb (SDB), laser SDB, and the AGM-176 Griffin missile.

### *Mission Sets*

The AC-130W Stinger II Gunship is a C-130 modified with a gun system, infrared and electro optical sensors, fire control systems, enhanced navigation systems, sophisticated communications, defensive systems, and inflight refueling capability. These systems give the gunship crew the capability to acquire and identify targets day or night, coordinate with ground forces and command and control agencies, and deliver accurate firepower in support of both conventional and SOF missions. The gunship's primary missions are close air support (CAS) and interdiction. The gunship is particularly well suited for the CAS mission and has a unique capability to deliver ordnance in extremely close proximity to friendly forces in a troops-in-contact (TIC) situation. Gunships can also perform interdiction and armed reconnaissance missions, particularly where limited collateral damage is required. The gunship can be employed in low- to medium-threat environments.



AC-130W

and infrared (IR) cameras. The weapons included on the aircraft are: 30mm side-firing cannon, AGM-176 Griffins, and GBU-39 SDBs. Many other weapons may be added to the AC-130W standard conventional load. Defensive systems include chaff and flares, combined with the large aircraft infrared countermeasures (LAIRCM) system, which provides the AC-130W robust protection from IR threat systems. The AC-130W provides a flexible range of organic capabilities which can be adapted to many different battlefield scenarios.

### *Additional Information*

AFTTP 3-1.AC-130W Tactical Employment (Note: Reference is classified)

## *MC-130H Combat Talon II*

### *Overview*

The MC-130H Combat Talon II is a multi-role aircraft that supports a wide range of activities from crisis response to wartime commitment in SOF missions. Normal tactical employment is night, low- to medium-altitude profiles. A day capability in a reduced-threat environment exists, but mission necessity must be weighed against increased threat effectiveness.

### *Mission Sets*

The mission of the Combat Talon II is to provide global, day, night, and adverse weather capability to airdrop and airland personnel and equipment in support of U.S. and allied SOF. The Combat Talon II conducts infiltration, exfiltration, resupply (using airland and/or

Table 5-2. AC-130W General Information

AC-130W Stinger II Gunship	
Length	97 ft., 9 in. (30.4m)
Height	38 ft., 6 in. (11.7m)
Wingspan	132 ft., 7 in. (40.4m)
Speed	290 KTAS
Weapons	30mm, AGM-176, & GBU-39
Max Takeoff Weight	155,000 pounds (69,750 kg), 175,000 pounds with waiver
Range	1,200 nautical miles, unlimited with air refueling
Crew	7: 2 pilots, 1 flight engineer, 2 CSO, 2 gunners

### *Equipment Characteristics and Specifications*

The AC-130W airframe has been heavily modified from a basic C-130, to the MC-130W Combat Spear, then the MC-130W Dragon Spear, and finally to the AC-130W STINGER II. The sensor suite includes two MX-20 high-definition KTAS sensors with electro-optic (EO)





MC-130H Combat Talon II

airdrop), MISO, and aerial reconnaissance in hostile or denied territory. Combat Talons are capable of inflight refueling, giving them an extended range. They are also capable of air refueling vertical-lift aircraft in support of extended operations. The Combat Talon missions may be accomplished either single-ship, multi-ship, or in concert with other special operations assets in varying multi aircraft scenarios. Combat Talons are able to airland/airdrop personnel and equipment on austere, marked and unmarked LZ/DZs, day or night. Combat Talon missions may require overt, clandestine, or low-visibility operations.

Table 5-3. MC-130H General Information

	MC-130H Combat Talon II
Length	99 ft., 9 in (30.4m)
Height	38 ft., 6 in. (11.7m)
Wingspan	132 ft., 7 in. (40.4m)
Speed	300 mph (480 kph)
Ceiling	33,000 ft. (10,000m)
Load	75 troops or 50 paratroopers
Max Takeoff Weight	155,000 pounds (69,750 kg), 175,000 pounds with waiver
Range	3,110 miles (2,700 nm), unlimited with air refueling
Crew	7: 4 officers (2 pilots, 1 navigator, 1 EWO), and 3 enlisted (1 flight engineer, 2 loadmasters)

### Equipment Characteristics and Specifications

The MC-130H Combat Talon II is a highly-modified C-130 transport designed for long-range, low-altitude,

night and/or adverse weather delivery of personnel and cargo, employing both airdrop and airland methods. The major aircraft modifications include the addition of a terrain following/terrain avoidance (TF/TA) radar, IDS, in-flight refueling (AR), an electronic combat suite (radar warning receiver [RWR], infrared warning receiver [IRWR], infrared countermeasures [IRCM], countermeasures dispensing system [CMDS], and electronic attack [EA]), and night vision goggle (NVG)-compatible lighting throughout the aircraft. The MC-130H is also capable of conducting helicopter/tilt rotor aerial refueling. MC-130H mission tasking should exploit the aircraft's payload, range, position accuracy, survivability capabilities, and its ability to avoid detection.

### Additional Information

AFTTP 3-3.MC-130 Combat Aircraft Fundamentals (Note: Reference is FOUO)

AFTTP 3-1.MC-130 Tactical Employment (Note: Reference is classified)

### MC-130J Commando II

#### Overview

The MC-130J Commando II is replacing the aging SOF fleet of MC-130E and MC-130P. The first aircraft was delivered in September 2011 to Cannon AFB, New Mexico, with final delivery expected in fiscal 2017. The aircraft was officially renamed Commando II from Combat Shadow II in March 2012.



MC-130J Commando II

### Mission Sets

The Commando II mission is clandestine or low visibility, single-ship or multi-ship low-level air refueling missions for special operations helicopters and tilt-rotor aircraft, and infiltration, exfiltration, and resupply of SOF by airdrop or airland intruding politically sensitive or hostile territories. The MC-130J primarily flies missions at night to reduce probability of visual acquisition and intercept by airborne threats. Its secondary mission includes the airdrop of leaflets. The MC-130J can be employed in a low- to medium-threat environment.

Table 5-4. MC-130J General Information

MC-130J Commando II	
Length	97 ft., 9 in. (29.3m)
Height	38 ft., 10 in. (11.9m)
Wingspan	132 ft., 7 in. (40.4m)
Speed	362 KTAS
Ceiling	28,000 ft.
Load	75 troops or 50 paratroopers
Max Takeoff Weight	164,000 pounds
Range	3,000 miles unrefueled
Crew	3: 2 pilots, 1 combat systems officer

### Equipment Characteristics and Specifications

The MC-130J includes: advanced two-pilot flight station with fully integrated digital avionics; fully populated combat systems operator and auxiliary flight deck stations; 13 color multifunctional liquid crystal displays; head-up displays; fully integrated navigation systems with dual inertial navigation system and global positioning system; integrated defensive systems; low power color radar; digital moving map display; new turboprop engines with six-bladed, all-composite propellers; digital auto pilot; improved fuel, environmental and ice protection systems; enhanced cargo-handling system; universal air refueling receptacle slipway installation

(UARRSI), air refueling pods, electro-optical/infrared (EO/IR) system; dual SATCOM for voice/data; 60/90 KVA generators; increased DC electrical output, loadmaster/scanner restraint system; and LAIRCM provisions.

### Additional Information

AFTIP 3-3.E/MC-130 Combat Aircraft Fundamentals (Note: Reference is FOUO)

AFTIP 3-1.E/MC-130 Tactical Employment (Note: Reference is classified)

## CV-22 Osprey

### Overview

The CV-22 Osprey is a tilt-rotor aircraft that combines the vertical takeoff, hover, and vertical landing qualities of a helicopter with the long-range, fuel efficiency and speed characteristics of a turboprop aircraft. The Osprey adds new capability and fills a long-standing USSOCOM requirement to conduct long-range infiltration, exfiltration, personnel recovery, and resupply missions during night operations.

### Mission Sets

The CV-22 takes off vertically and, once airborne, the nacelles (engine and prop-rotor group) on each wing can rotate into a forward position. This versatile, self-deployable aircraft offers increased speed and range over other rotary-wing aircraft, and can perform missions that normally would require both fixed-wing and rotary-wing aircraft. The Osprey can cruise at over 230-240 mph, and has a range three times greater than the MH-53J. It is also much quieter, thereby reducing exposure to enemy threats.

Table 5-5. CV-22 General Information

CV-22 Osprey	
Length	57 ft., 4 in. (17.4m)
Height	22 ft., 1 in. (6.73m)
Wingspan	84 ft., 7 in. (25.8m)
Speed	277 mph (241 kts cruising speed)
Max Vertical Takeoff Weight	52,870 pounds (23,982 kilograms)
Max Rolling Takeoff Weight	60,600 pounds (27,443 kilograms)
Range	1,500 nm, more than 2,500 nm is possible with 1 aerial refueling and auxiliary tanks
Crew	4: pilot, copilot, 2 enlisted flight engineers

**Equipment Characteristics and Specifications**

The CV-22 has an advanced electronic warfare suite, a multi-mode radar which permits flight at very low altitude in zero visibility, a retractable aerial refueling probe, and four secure radios.

**Additional Information**

AFTTP 3-3.CV-22 Combat Aircraft Fundamentals (Note: Reference is FOUO)  
 AFTTP 3-1.CV-22 Tactical Employment (Note: Reference is classified)

**EC-130J Commando Solo**

**Overview**

Commando Solo has been employed in every major contingency since 1970, to include Operation Desert Shield/Storm, Operation Sea Signal/Uphold Democracy, Operation Joint Guard, Operation Southern Watch/Desert Thunder, Operation Allied Force, Operation Enduring Freedom, Operation Iraqi Freedom (2) and Operation Secure Tomorrow.

**Mission Sets**

Commando Solo conducts information operations in support of combatant commanders' objectives during all phases of war, military operations other than war, and civil operations. EC-130J aircraft are primarily employed for influence operations and secondarily for electronic warfare. Tertiary missions include collection and command and control radio relay. Solo can also be employed by civil authorities to support strategic communications and humanitarian or disaster relief operations.

Table 5-6. EC-130J General Information

EC-130J Commando Solo III	
Length	97.75 ft., 9 in. (29.7m)
Height	38.8 ft. (11.8m)
Wingspan	132 ft., 6 in. (40.3m)
Speed	310 mph
Ceiling	28,000 ft.
Max Takeoff Weight	164,000 pounds
Range	2,300 nm unrefueled
Crew	10: 2 pilots, flight systems officer, mission systems officer, loadmaster, 5 electronic communications systems operators



CV-22

**Equipment Characteristics and Specifications**

Eight special mission transmitters are installed in each EC-130J. They are capable of high power (1,000 Watts to 10,000 Watts) transmissions in the frequency range from 0.450 MHz to 1000 MHz. Seven full-power transmissions can be performed simultaneously. Broadcast frequencies can be discrete, which ensures transmissions will not interfere with adjacent frequencies or channels. Transmissions can be adjusted to coincide with established worldwide telecommunication standards. Modes of operation include AM, FM, CW, SSB, ISB and color analog television in any standard worldwide. Thirteen antennas are dedicated to special mission transmissions. They include high gain, directional VHF and UHF antennas as well as omnidirectional stubs. Two length-adjustable trailing wire antennas are available for MF and HF operations. An additional



EC-130J

four antennas are dedicated to special mission receivers. Five special mission receivers provide signal reception in the frequency range of 0.250 MHz through 1100 MHz. Received signals can also be retransmitted or recorded. Two spectrum analyzers with a frequency range of 9 kHz to 26.5 GHz are installed to provide analysis of both received and transmitted signals. The spectrum analyzers also provide a receive capability. This suite of equipment can also be used in intelligence gathering functions.

**Additional Information**

AFTIP 3-3.E/MC-130 Combat Aircraft Fundamentals (Note: Reference is FOUO)

AFTIP 3-1.E/MC-130 Tactical Employment (Note: Reference is classified)

**C-145A Combat Coyote**

**Overview**

The C-145A is the U.S. Air Force designation for the PZL M-28 Skytruck commercial variant, utility aircraft that provides intra-theater support for SOF. The M-28 was selected for its versatile performance characteristics and ability to operate from short and unimproved runway surfaces.

**Mission Sets**

The C-145A Combat Coyote is certified to land on dirt and grass strips, the aircraft is equipped with weather radar, missionized communications and navigation gear. This unpressurized twin-engine utility aircraft has a crew of two pilots and one load master. The aircraft can operate from shorter runways than a C-130 and can carry up to 16 passengers or a payload of 5,000 pounds.



C-145A

**Additional Information**

AFSOCH 11-145 Tactical Employment (Note: Reference is classified)

Table 5-7. C-145A General Information

C-145A Combat Coyote	
Length	43 ft.
Height	15 ft., 1 in.
Wingspan	72 ft., 4 in.
Speed	220 KTAS
Ceiling	25,000 ft.
Load	5,000 pounds
Max Takeoff Weight	16,534 pounds
Range	730 nm
Crew	3: 2 pilots, loadmaster

**C-146A (Do-328) Wolfhound**

**Overview**

The C-146A is the U.S. Air Force designation for the Dornier Do-328 utility aircraft that provides inter- and intra-theater support for SOF. This regional turbo-prop can operate from shorter runways than a C-130 and can carry up to 32 passengers or a payload of up to 8,135 pounds.

**Mission Sets**

The C-146A Wolfhound is a twin-engine utility aircraft that has a crew of two pilots and a single load master. Selected for its speed, versatile performance characteristics and ability to operate from short and unimproved runway surfaces, this aircraft is also certified to land on dirt and grass strips.

**Equipment Characteristics and Specifications**

The aircraft is equipped with weather radar and missionized communications and navigation gear. This regional turbo-prop can operate from shorter runways than a C-130 and can carry up to 32 passengers or a payload of up to 8,135 pounds.



C-146A

Table 5-8. C-146A General Information

C-146A Wolfhound	
Length	69 ft., 10 in.
Height	23 ft., 9 in.
Wingspan	68 ft., 10 in.
Speed	335 KTAS
Max Takeoff Weight	30,843 pounds
Range	2,000 nm
Crew	3: 2 pilots, loadmaster

## U-28A

### Overview

The U-28A is the Air Force variant of the Pilatus PC-12 and was selected for its versatile performance characteristics and ability to operate from short and unimproved runway surfaces.

### Mission Sets

The U-28A is primarily an ISR aircraft. The aircraft is equipped with weather radar and a suite of advanced communications and navigation gear. This single-engine utility aircraft has a crew of two, but can be flown by one pilot. The aircraft can operate from shorter runways than a C-130.

Due to its efficient design and the use of a single-engine, the direct operating cost is about a third less than a comparable multi-engine aircraft and nearly half that of the nearest comparable jet.

### Equipment Characteristics and Specifications

The U-28 has multiple secure communications suites. The aircraft is equipped with two sensors with capabilities of a day variable-aperture TV camera, a variable-aperture infrared camera (for low light/night), and a synthetic aperture radar for looking through smoke, clouds or haze.

Table 5-9. U-28A General Information

U-28A	
Length	47 ft., 3 in.
Height	14 ft.
Wingspan	53 ft., 3 in.
Speed	270 KTAS
Max Takeoff Weight	9,920 pounds
Range	1,513 miles
Crew	3: 2 pilots, CSO



U-28A

### Additional Information

AFITP 3-1.U-28 Tactical Employment (Note: Reference is classified)

## MQ-1B Predator

### Overview

The MQ-1 Predator is a medium-altitude, long endurance, remotely piloted aircraft with associated personnel and equipment. The MQ-1's primary mission is interdiction and armed reconnaissance against critical, perishable targets. The Predator can operate from a 5,000 by 75 foot (1,524 meters by 23 meters), hard surface runway with clear line-of-sight.

### Mission Sets

The Predator is a system, not just an aircraft. A fully operational system consists of four aircraft (with sensors), a ground control station, a Predator primary satellite link (PPSL), and approximately 55 personnel for deployed 24-hour operations. The major components can be deployed for worldwide operations on relatively



MQ-1 Predator

short notice. Predator aircraft are disassembled and loaded into “coffins.” The ground control system is transportable in a C-130 (or larger) transport aircraft. The basic crew for the Predator is one pilot and one sensor operator. They fly the aircraft from inside the ground control station via a C-band line-of-sight data link or a Ku-band satellite data link for beyond line-of sight flight.

### Equipment Characteristics and Specifications

The MQ-1 Predator carries the multi-spectral targeting system (MTS) with inherent AGM-114 Hellfire missile targeting capability, and integrates EO/IR, laser designator and laser illuminator into a single sensor package. The aircraft can employ two laser-guided Hellfire anti-tank missiles with the MTS ball. The aircraft is

Table 5-10. MQ-1B General Information

MQ-1B Predator	
Length	27 ft. (8.2m)
Height	6.9 ft. (2.1m)
Wingspan	55.25 ft. (16.8 m)
Speed	84-135 mph
Ceiling	25,000 ft. (7,620 meters)
Max Takeoff Weight	2,250 pounds
Range	400 nm
Crew	2: pilot, sensor operator

equipped with a color nose camera (generally used by the pilot for flight control), a day variable-aperture TV camera, a variable-aperture infrared camera (for low light/night), and a synthetic aperture radar for looking through smoke, clouds or haze. The cameras produce full motion video. The ground data terminal antenna provides line-of-sight communications for takeoff and landing. The PPSL provides over-the horizon communications for the aircraft. An alternate method of employment, remote split operations, employs a smaller version of the ground control station (GCS) called the launch and recovery GCS. The launch and recovery GCS conducts takeoff and landing operations at the forward deployed location while the CONUS based GCS conducts the mission via extended communications links. The aircraft also includes an ARC-210 radio, an APX-100 IFF/SIF with Mode 4, and an upgraded turbocharged engine. The latest upgrade includes fuel injection, longer wings, dual alternators, and other improvements.

### Additional Information

AFTTP 3-3.MQ-1 Combat Aircraft Fundamentals (Note: Reference is FOUO)

AFTTP 3-1.MQ-1 Tactical Employment (Note: Reference is classified)

### MQ-9 Reaper

#### Overview

The MQ-9 Reaper is a medium- to high-altitude, long endurance remotely piloted aircraft system. The MQ-9's primary mission is as a persistent hunter-killer against emerging targets to achieve joint force commander objectives. The MQ-9's alternate mission is to act as an intelligence, surveillance and reconnaissance asset, employing sensors to provide real-time data to commanders and intelligence specialists at all levels.

#### Mission Sets

The typical system consists of several aircraft, a ground control station, communication equipment and links, spares, and personnel who can be a mix of active duty and contractor personnel. The crew for the MQ-9 is a pilot and a sensor operator, who operate the aircraft from a remotely located GCS. To meet combatant commanders' requirements, the MQ-9 delivers tailored capabilities using mission kits that may contain various weapons and sensor payload combinations.

### Equipment Characteristics and Specifications

The MQ-9 baseline system has a robust sensor suite for targeting. Imagery is provided by an infrared sensor, a color/monochrome daylight TV and an image-intensified TV. The video from each of the imaging sensors can be viewed as separate video streams or fused with the IR sensor video. The laser rangefinder/designator

Table 5-11. MQ-9 General Information

MQ-9 Reaper	
Length	36 ft. (11m)
Height	12.5 ft. (3.8m)
Wingspan	66 ft. (20.1m)
Speed	230 mph
Ceiling	50,000 ft.
Max Takeoff Weight	10,500 pounds
Range	3,682 miles
Crew	2: pilot, sensor operator



MQ-9 Reaper

provides the capability to precisely designate targets for laser guided munitions. Synthetic aperture radar will enable Joint Direct Attack Munitions targeting. The aircraft is also equipped with a color nose camera, generally used by the pilot for flight control. Each MQ-9 aircraft can be disassembled into main components and loaded into a container for air deployment worldwide in Air Force airlift assets such as the C-130. The MQ-9 air vehicle operates from standard U.S. airfields.

#### *Additional Information*

AFTTP 3-3.MQ-9 Combat Aircraft Fundamentals  
(Note: Reference is FOUO)

AFTTP 3-1.MQ-9 Tactical Employment (Note: Reference is classified)

#### *Small Unmanned Aviation Systems*

Small UAS aircraft, to include Ravens, Pumas, and Scan Eagles, are widely deployed and expanding within AFSOC.

## Special Tactics Squadrons (STS)

Special tactics squadrons are fast-reaction, rapidly deployable Air Force units comprising combat control team (CCT), pararescue (PJ), special operations weather team (SOWT), tactical air control party (TACP), and specialized mission support personnel. STSs are organized, trained, and equipped to conduct special operations core tasks during high-risk combat operations where the effective integrations of airpower and/or recovery of personnel and equipment are imperative to mission success.

STSs support SOF commanders as well as enable the air component commander's global strike, global mobility, global response, and global engagement operations by providing unique capabilities. These capabilities include the coordination, integration, and synchronization of air and space power as a tactical enabling force (assault zone survey, assessment, establishment, and control; terminal attack control; direct action; environmental and special reconnaissance; and austere weather operations) as well as personnel recovery, battlefield trauma care, and hardware destruction or recovery. Teams are capable of operating independently in permissive or non-permissive environments, or as augmentation to other special operations elements in hostile environments.

### Mission

The special tactics mission is to provide the joint force commander with austere air traffic control; assault zone (LZ/DZ) survey, assessment, establishment, and control; close air support using strike aircraft and gunship missions; weather observations; environmental reconnaissance; personnel recovery; and advanced trauma care.

### Specific Employment

Special tactics teams (STTs) operate worldwide, in a ground role with joint and combined special operations task forces. SOWTs conduct environmental reconnaissance; collecting critical meteorological, oceanographic, geographic, and hydrologic information and conduct austere weather operations; generating mission-tailored forecasts and assessing environmental impacts on current and planned special operations.



A pararescueman climbs to rescue trapped earthquake victims in Port-au-Prince, Haiti.

STTs can be employed in support of the full range of special operations core tasks to include direct action, special reconnaissance, UW, FID, combat search and rescue, personnel/equipment recovery, humanitarian assistance, and civil affairs. Combat controllers can establish landing zones at unprepared sites, semi-prepared sites, and even international airports; once in place, CCT provide FAA-certified air traffic control services for all aircraft within their designated airspace. When attached to USAF contingency response groups, these teams deliver air traffic capability to the Air Force's "open the airbase" concept of operation.

### Deployment

STTs can be deployed by airlift, sealift, or overland means. STT manpower and personnel are tailored to the mission. To airlift a capable 18-man STT to a forward base requires one C-17. However, the force also has smaller, modular force packages that can be airlifted to the objective area on a C-130 or helicopter, mission dependent. Deployment can be worldwide to a main base or forward operating location. Teams will require host support at the deployed location.

STTs have several combat modular packages differing slightly in mission capability and mix of personnel and equipment designed to conduct the full range of combat control missions. Once deployed, the team leader can tailor exact team composition and equipment to meet specific employment mission requirements. SOWTs



normally deploy with their respective Army Special Operations units (typically, four SOWTs per SFG).

### Employment

STTs may be tactically employed directly from their home station or from deployed locations. ST forces can be employed as stand-alone units or combined with other special operations/conventional forces into a joint team. STTs may be employed using a variety of tactical methods including:

- a. Static line or military free-fall parachute
- b. SCUBA, small boat, or amphibious means
- c. Overland using mounted/dismounted techniques
- d. Airland via fixed-wing or vertical-lift aircraft
- e. Airmobile procedures, including fastrope, rope ladder, rappel

An STT is the basic tactical element for ST forces, but its size depends on mission requirements. A CSAR team typically comprises two or three pararescuemen and one combat controller. When attached to a U.S. Army SFOD-A or SEAL platoon to provide fire support expertise, a single combat controller or TACP can perform the mission if he has a JTAC certification. ST survey teams consist of one to four combat controllers, and conduct surveys as tasked, with security typically arranged by the unit requesting the assault zone survey. For austere airfield establishment and control, four to eight combat controllers can conduct the mission, depending on complexity. SOWTs operate as single operators attached to Army special operations units or STTs to conduct environmental reconnaissance or austere weather operations. Teams tasked for recovery missions will comprise a mix of pararescuemen and combat controllers, the total number being mission-dependent.

### Mission Tasks

- a. Provide terminal guidance and air traffic control for assault zones (AZ). An AZ may be an established airfield, landing strip, unimproved site, helicopter landing zone, or drop zone. A team can:
  - Establish ground-to-air communications
  - Coordinate AZ activities with the ground force commander
  - Perform weather observations



Motorcycles and all-terrain vehicles provide STS personnel rapid mobility throughout the airfield environment.

- Provide positive control of personnel and equipment within the airhead area to include control of forward arming and refueling point (FARP) operations
- b. Select, evaluate, survey, and establish AZs. The special tactics team can:
    - Clear, mark, and operate the AZ
    - Establish enroute and terminal navigation aids and beacons
    - Conduct reconnaissance/surveillance missions
    - Support selected regional survey team (RST) missions
    - Remove obstacles to flight for follow-on operations
  - c. Provide medical care, recovery, and evacuation. The STT can:
    - Provide combat emergency medical and trauma care
    - Operate specialized personal locator systems
    - Operate combat medical evacuation vehicles
    - Lead search-and-rescue (SAR) security team operations
    - Conduct casualty transload and evacuation operations
    - Conduct sensitive recovery operations
  - d. Conduct, coordinate, and plan fire support operations. The STT can:
    - Control CAS aircraft
    - Control naval gunfire
    - Control artillery and mortar fires
    - Operate laser targeting equipment
    - Report battlefield damage assessment

- e. Conduct UW and FID activities. The team can advise, train, and assist allied or indigenous personnel in:
  - Assault zone, communications, and other special operations
  - Combat medical and related casualty treatment procedures
  - Combat search and rescue operations
  - Other special tactics/operations related procedures
  - Collecting and reporting limited weather observations
- f. Conduct environmental reconnaissance; collect and report meteorological, oceanographic, geographic and hydrologic information to assess threats and suitability.
  - Collect and report surface weather conditions
  - Collect and report coastal or near-littoral conditions
  - Collect and report snowpack and assess avalanche threat
  - Collect and report on riverine systems and assess flood threat
  - Collect and report on terrain conditions
  - Collect and report upper air soundings
- g. Conduct austere weather operations.
  - Generate mission execution forecasts
  - Generate real-time forecasts (nowcasts)
  - Generate environmental impact analysis
  - Establish and manage limited observation networks

### *Basic Planning Considerations*

- a. STTs deploy with the minimum equipment and supplies to complete the mission. They are normally equipped to operate for up to 72 hours without resupply. Operations of more than 72 hours require resupply of additional equipment, batteries, fuel, water, and rations.
- b. Operations in excess of 72 hours or multiple ST taskings are considered sustained operations, and a special tactics operations center (STOC) and Logistics force module deploys with the employing teams to support their command/control, planning, and mission support requirements. The STOC should be deployed to the nearest available staging or operations base with access to the tactical teams area of operations.
- c. Mission effectiveness is highly dependent upon accurate, complete, real-time intelligence. ST planners must have access to all intelligence sources.
- d. The time required for STTs to prepare for a mission varies with the complexity and length of the mission. As a rule of thumb, a tactical

team requires at least 12 hours to provide adequate pre-mission time to conduct final planning, brief team members and decision-makers, and ready equipment. Any preliminary mission planning or preparation time must be added to this 12-hour figure.



AFSOC combat controllers provided primary air traffic control into Toussaint L'Ouverture International Airport, Port-au-Prince, Haiti, after the 2010 earthquake.

## Combat Aviation Advisors (CAA)

### Mission

The Air Force Special Operations Air Warfare Center (AFSOAWC), located at Hurlburt Field, Florida (described on page 5-37), is home to the 6th Special Operations Squadron (SOS). The 6 SOS is the only dedicated foreign internal defense (FID) unit in AFSOC. The 6 SOS's mission is to assess, train, and advise partner nation aviation units on the full spectrum of fixed-wing aviation tasks, from planning to maintaining to actually flying. All 6 SOS CAAs are language trained and culturally astute Airmen. The 6 SOS and 711 SOS (Reserve Component) perform the aviation FID mission across the operational continuum, but have specialized application in three operating arenas: FID, unconventional warfare, and coalition support.

The CAA mission includes advising combatant commanders, civilian agencies, and foreign aviation units on planning and integrating foreign air operations into theater campaign plans, contingencies, and other joint and multinational activities. The mission set addresses airpower tactical employment of fixed-wing aircraft, aircraft maintenance, air base supply, munitions, ground safety, life support, personal survival, airbase ground defense, command, control, communications, and computers (C4), and other sustainment functions supporting combat air operations.

### Operating Rationale

CAA training and advisory capabilities are primarily relevant to the joint force special operations component commander/joint special operations task force commander and to the joint force air component commander for purposes of integrating foreign aviation forces into combined theater air operations during contingencies and larger-scale theater campaigns. In this respect, CAAs function as “coalition airpower enablers.”

- a. During war and certain contingency operations, CAA capabilities that promote safety and interoperability within the coalition extend the flexibility and range of options available to the JFC. These capabilities are particularly relevant when the total air effort requires foreign air support



A Combat Aviation Advisor in a modified C-47 aircraft with a host-nation aircrew

- augmentation or when unilateral U.S. combat air actions are infeasible or inappropriate.
- b. Strengthening the airpower capabilities of friendly and allied nations through training and advisory assistance can reduce foreign dependence on the United States for certain forms of air support, such as airlift, tactical insertion/extraction, resupply, and CSAR.
- c. CAAs offer the JFC and combat air forces (CAF) a practical means of maintaining contact over extended periods of time with foreign air force leadership and government authorities to open and maintain channels of communication and coordination for future contingencies. Close contact with foreign air force commanders, for instance, is crucial in obtaining or coordinating support and cooperation for U.S. conventional or special operations activities conducted abroad. CAA advisors can assist the CAF in pursuing military-to-military contacts with foreign aviation forces in such areas as capabilities assessments, bilateral exercise planning and execution, information exchanges, and unit exchange training events.
- d. Small unit deployments by training and advisory personnel supporting the combatant commander's engagement strategy offer a politically and economically feasible means to show commitment, lend credibility to our alliances and U.S.

overseas interests, enhance regional stability, and at the same time provide an immediate response capability.

- e. CAAs support various military commands and civilian agencies in such areas as airpower assessments, site surveys, technical advisory services, and certain forms of training and instruction.

### *Concept of Operations*

CAA operations are inherently and predominantly joint in nature. All own-unit training is conducted in accordance with the unit's mission-essential task list. In selecting training events, the squadron seeks to maximize opportunities to train in a joint environment and to acquire competency in the tasks the squadron must perform to meet regional combatant commanders' needs.

- a. When tasked, CAA personnel deploy, collocate with HN aviation elements at a squadron, wing, or headquarters level, and train and/or advise counterpart personnel in airpower employment and sustainment. Training and advisory assistance is conducted at both the operational and tactical levels. The focus is on mobility, ISR, and light strike mission areas.
- b. CAA teams do not deploy with aircraft. Aircrews fly with foreign counterparts at the deployment location, using HN aircraft, to assess capabilities and determine current levels of proficiency and safety. CCA instructors may then train HN aviation personnel in required TTPs—again, using HN aircraft—for joint and combined warfare.
- c. All training and advisory efforts involving flying are preceded by an assessment of the airworthiness and safety of the HN unit's aircraft and crews. The assessment is required for familiarization with HN aviation capabilities and procedures prior to commencement of combined operations. It is also required as a basis for conducting risk analysis and risk management procedures, and for estimating the potential of combined interoperability.
- d. CAA tactical flying training will, in some cases, be required to bring HN aviation forces to the point where they can be advised in airpower applications supporting theater and/or air campaign

objectives. The basic steps in this process are sequential—assess, train, advise, assist, and integrate.

- e. CAA tactical aircrews may be required to fly with HN counterparts on certain missions to provide the needed margin of safety and reliability, especially when supporting U.S. or U.S.-advised forces.

### *Employment*

Deployed CAA teams support the geographic combatant commander, joint force commander, and subordinate component commands throughout the range of military operations, from military operations other than war and contingency operations to major regional conflict. CAA advisory and training operations are primarily aimed at helping foreign friends and allies employ and sustain their own aviation resources, not to conduct operations for them. The principal tactical objective of CAA combat aviation advisory operations is to facilitate the availability, reliability, safety, and interoperability of foreign aviation forces. Operations, in both the conventional and special operations arenas, primarily focus on hands-on, adaptive training and advisory support geared to practical applications in host countries. Squadron advisory capabilities primarily focus on fixed-wing special operations oriented airlift for personnel recovery; tactical assault; and aerial insertion, extraction, and resupply. The squadron also maintains the capability to function in a direct-execution role if required. The following describes each element of the mission set.

- a. Aviation assessments are carried out primarily in support of geographic combatant commanders and subordinate commands and for other key agencies and departments of the USG. Assessments focus on foreign aviation capabilities and limitations, specifically aircrew capability and safety, aircraft airworthiness, and critical resource availability, resource sustainability, and operational potential.
- b. Aviation training enables foreign aviation units to accomplish a variety of missions, technical functions, and skills. Training covers a variety of product subsets, including TTPs in such areas as search and rescue, air-ground interface, aircraft maintenance, survival, and air base defense. Training, as

a key task, is neither time nor situation specific. But appropriately funded training can be used to close specific gaps in foreign aviation skills and bring them up to levels of competency where they can be advised on how to employ their acquired capabilities. CAAs do not train foreign personnel in basic military skills.

- c. Aviation advisory support enables foreign aviation forces to employ and sustain their own resources within the context of specific times, places, and operational situations. Advising includes such product subsets as real-world mission planning, tactical employment, sustainment methods, basing concepts, C4 systems, and uses of airpower (how to employ airpower as opposed to how to operate airplanes).
- d. As with U.S. Army SF, CAAs can assist foreign aviation forces in executing specific tasks, operations, and missions through direct participation in tactical operations and events, as well as through technical and operational means, including training, advising, and logistics support. With appropriate direction and authority, CAA can also furnish joint force commanders direct aviation support employing a variety of USAF and non-USAF aircraft.
- e. CCA teams facilitate force integration by bringing all other key tasks (assessing, training, advising, and assisting) together in a coordinated effort to draw foreign aviation forces into joint and combined multinational operations supporting theater campaigns and contingencies. The object is to create joint and combined battlefields for theater operations and contingencies.

### *Specialized Training Characteristics*

The AFSAWC trains, plans, and conducts operations so as to maximize the effectiveness of advisory skills, which include several specialized features of the organization—foreign language capability, political and cultural sensitivity, area orientation, tailored force packaging, mission-specific training, and competency in nonstandard aircraft and aviation support programs.

- a. All CAA personnel are volunteers who under-go an arduous assessment and selection process to



An Operational Aviation Detachment-A (OAD-A) team with host-nation ground forces and aircrew

ensure they are suitable in adapting to this complex mission. All must be qualified instructors in a particular Air Force specialty code. Approximately six months of advisor-related, individual, and team-oriented training equips these individuals with area orientation, field craft, and “move, shoot, and communicate” ground operating skills that prepare them to function successfully in the joint, multinational, and interagency arenas. Achieving and maintaining mission-ready status in the 6 SOS entails extensive training in such areas as advanced weapons, personal survival, political-military affairs, combat aviation advisory doctrine, security assistance law, academic instructor methods, area/theater orientation, and a foreign language.

- b. The seasoned CAA is distinguished by such attributes as cultural and political astuteness, adaptability to field conditions, and in-depth knowledge of U.S. and foreign military command and control structures. The professional advisor can plan, execute, and recover in a variety of mission scenarios with little assistance, and do it all within the spirit and intent of current operating instructions and public laws governing operations with foreign military forces.
- c. Squadron personnel undergo extensive training prior to being certified as “mission ready.” This includes training and education in a variety of individual skills such as cross-cultural communications, regional area orientation, battle space command and control, and conflict analysis. Additionally, integrated skills training (IST) is

administered to all squadron personnel prior to achieving mission-ready status.

### Organization

The 6 SOS is assigned to the AFSOAWC, which, in turn, reports to HQ AFSOC. These organizations are located at Hurlburt Field. The 6 SOS is also located at Duke Field, Florida.

- a. The 6 SOS is organized in garrison as regionally-oriented flights aligned under an operations officer and a squadron commander. For overseas deployment, the squadron is organized around operational aviation detachments “A” and “B” (OAD-A and OAD-B).
- b. The OAD-A, or A team, is the basic 6 SOS tactical deployment module for combat aviation advisory operations. It is structured around a (notional) 13-person, multidisciplined, language-qualified team focused on assessing, training, advising, and assisting foreign aviation units.
- c. The OAD-B, or B team, is the basic infrastructure support element for deployed operations. It is organized around a (notional) 10-person support team focused on providing command, control, communications, logistics, administrative, and medical support to one or more deployed OAD-A teams.
- d. The OAD-A and OAD-B teams are specially tailored in both size and composition to meet specific mission needs.

#### Aviation FID OAD-A Composition – OAD-A notionally a 10-man team

- a. Pilots
- b. Aircrew, non-pilot
- c. Maintenance
- d. Special tactics (requires augmentation from 24 SOW)
- e. Communications
- f. Logistics
- g. Intelligence
- h. Security Forces
- i. Mission commander and team sergeant

#### OAD-B Composition (mission tailored C2 attached to a JSOTF)

- a. Team leader/mission commander
- b. Operations officer

- c. Flight surgeon (augmented resource)
- d. Medic (augmented resource)
- e. Communications (augmented resource)
- f. Administrative specialist
- g. Maintenance officer
- h. Logistics officer
- i. Plans officer
- j. Intelligence officer

### Operating Arenas

Although 6 SOS capabilities can be employed throughout the range of military operations, CAA teams have specialized applications in three principal operating arenas where employment of foreign aviation forces is of direct interest to combatant commanders—FID, UW, and coalition support, typically in austere/hostile/uncertain environments when a small footprint/low signature is desired.

#### Foreign Internal Defense (FID)

FID is the total political, economic, informational, and military assistance the United States provides to a friend or ally to help them deal with the internal problems of subversion, lawlessness, and insurgency. The aviation aspect of FID is essentially one of training and advising HN aviation forces in the sustained use of airpower to help their governments deal with these internal threats. HN programs in the arena are often referred to as internal defense and development plans or strategies. The key term here is internal.

- a. FID, by nature a joint interagency activity, is established under U.S. public law as a principal USSOCOM task. Advisory assistance and training are major components of FID. Although the term FID is widely understood throughout the USG, its use is largely restricted to DOD organizations.
- b. Commander, USSOCOM, has designated AFSOC as the proponent for the aviation portion of FID, with functions and responsibilities described in Appendix C-3, USSOCOM Directive 10-1. AFSOC/CC has in turn, designated the AFSOAWC as the primary organization to plan, coordinate, and manage aviation-FID activities.
- c. Operations associated with aviation-FID primarily include support to host nation counterinsurgency and counternarcotics programs. Aviation

FID is intended to function as a complement to other special operations forces involving ground, maritime, and riverine advisory assistance.

### *Unconventional Warfare (UW)*

UW consists of those activities conducted to enable a resistance movement or insurgency to coerce, disrupt, or overthrow a government or occupying power by operating through or with an underground, auxiliary, and guerrilla force in a denied area. It includes guerrilla warfare and other direct offensive, low-visibility, clandestine, or covert operations, as well as the indirect activities of subversion, sabotage, intelligence activities, and evasion and escape.

- a. There are several major aspects to UW. One aspect involves support to insurgency, i.e., guerrilla warfare. Another aspect includes actions aimed at preparing the engagement arena prior to, or in conjunction with, the introduction of main battle forces. These are “direct, offensive actions,” undertaken to disrupt and isolate enemy resources and nodes, and to build friendly command, control, communication, and computer intelligence and escape and evasion nets supporting theater campaign objectives.
- b. 6 SOS UW support includes training and advising foreign aviation forces supporting friendly indigenous assets located in the engagement arena (partisan forces, for example) through aerial insertion, extraction, and resupply, possibly from a third-country sanctuary.

### *Coalition Support*

Other than quick, one-time contingencies, any significant and sustained U.S. military action overseas is likely to be conducted under some type of coalition arrangement. Coalition support may be conducted in different conflict arenas, including FID contingency actions and regional warfare. Specialized tasks are involved. Whereas conventional forces conduct coalition warfare, 6 SOS is organized and trained to operate along the seams of contact between U.S. and coalition forces—to keep the coalitions connected at the tactical level. This requires 6 SOS CAAs to engage coalition aviation forces with training and advisory assistance at the tactical level, in counterpart aircraft, in tactical environments.

- a. Coalition support activities of the 6 SOS encompasses actions to facilitate integration and/or coordination of foreign aviation forces into combined operations supporting mutual campaign objectives. As a logical extension of these actions, squadron personnel may be required to assist foreign coalition partners in operational-level planning and force integration. 6 SOS personnel can also assist U.S. combatant commanders, component forces and civilian agencies in planning and integrating foreign air support into theater campaign plans, contingencies, and other joint multinational activities.
- b. Coalition support includes advisory liaison functions to promote and test safety and interoperability; facilitate area defense coordination and airspace deconfliction; help integrate foreign aviation efforts into combined air campaign planning; increase tactical effectiveness of foreign aviation resources; and maintain vital coordination links between foreign aviation units and joint, combined air tasking authorities.

### *Tasking*

Formal requests for 6 SOS support should be channeled through the combatant commander in whose areas of responsibility the support would take place. Requests are forwarded, in turn, through the TSOC to USSOCOM and HQ AFSOC.

Inquiries regarding CAA capabilities and availability should be directed through USSOCOM to HQ AFSOC. Formal requests for 6 SOS support of security assistance-funded mobile training teams are handled in accordance with current directives and regulations governing security assistance. These requests are channeled through USSOCOM to HQ AFSOC. A Joint Chiefs of Staff deployment order (JCS tasking) is usually required for deployments involving contact with foreign military forces.

# Air Mobility Command (AMC) C-17 SOLL II

## Overview

The C-17 SOLL II forces from the Air Mobility Command (AMC) conduct provide highly reliable, self-contained, precision airdrop/airland of personnel and equipment. The assumed mission concept will be day/night, low level, adverse weather, without the use of external aids. The C-17 is well suited for many special operations applications due to its load carrying capability, short runway capability, and its world-wide signature. The C-17 can take-off and land on runways as short as 3,500 feet with a width of only 90 feet.

Table 5-12. C-17 SOLL II General Information

C-17 SOLL II	
Length	174 ft.
Height	55 ft., 1 in.
Wingspan	169 ft., 10 in.
Speed	450 knots at cruise
Ceiling	45,000 ft.
Max Takeoff Weight	585,000 lbs with a payload of 170,900 lbs
Range	2400 nm unrefueled range, global reach with in-flight refueling
Crew	7: 3 pilots, 2 loadmasters, 1 communication specialist, and 2 maintenance special operations personnel (MASOP)

## Additional Information

AFTTP 3-3.C-17 Combat Aircraft Fundamentals (Note: Reference is FOUO)

AFTTP 3-1.C-17 Tactical Employment (Note: Reference is classified)



An Air Force C-17 Globemaster III takes off from an airbase in Southwest Asia.



Airmen offload an AH/MH-6M helicopter from a C-17 SOLL II.



# Air Force Special Operations Air Warfare Center (AFSOAWC)

The AFSOAWC organizes, trains, educates and equips forces to conduct special operations missions; leads AFSOC IW activities; executes special operations test and evaluation and lessons learned programs; and develops doctrine, TTPs for Air Force SOF. It also is responsible for the transformation of Airmen into Air Commandos who possess the specialized skills and warrior ethos to fight and win anytime, anywhere. AFSOAWC was established in 2013 at Hurlburt Field, Florida. The center is evolving and the units currently assigned are listed.



## 551st Special Operations Squadron

The 551 SOS provides AFSOC's Western Air Commandos with unmatched combat training. Its mission is to conduct initial mission qualification and upgrade training for the AC-130W, MC-130J, CV-22, Remotely Piloted Aircraft and all manner of light/medium commercial aviation transport aircraft.

## 5th Special Operations Squadron

The 5 SOS executes the global special operations mission as part of the Air Force component of USSOCOM. The 5 SOS is a reserve squadron associated with the AFSOAWC, directed to conduct formal special operations aircrew training. It accomplishes this mission by providing instruction in covert night infiltration, resupply, and combat infiltration/ex-filtration operations. The 5 SOS is the only reserve squadron flying light/medium commercial aviation transport aircraft.

## 371st Special Operations Combat Training Squadron

AFSOC's formal school for Small UASs and IW skills training. Responsible for specialized training of combat-ready joint SOF. AFSOC's designated agent for recruiting of designated SOF aircrew members. Conducts distributed mission operations and mission rehearsal in

## 19th Special Operations Squadron

The 19th SOS is AFSOC's largest formal school and advanced mission rehearsal organization. Responsible for specialized training of combat-ready SOF to conduct covert, clandestine, and contingency operations. Exploits advanced technologies to provide realistic mission rehearsal during preparation for high-risk special operations missions directed by the SecDef. Any time, any place.

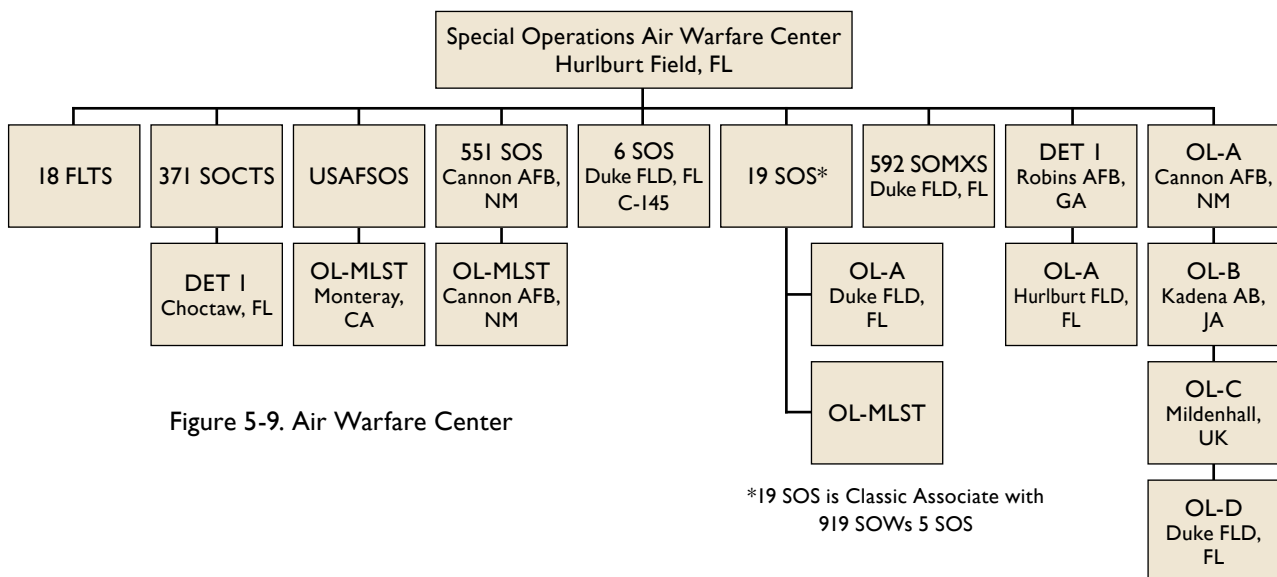

Figure 5-9. Air Warfare Center

\*19 SOS is Classic Associate with 919 SOWs 5 SOS

support of joint and multinational users. Provides training support to all AFSOAWC-gained units.

### ***280th Combat Communications Squadron***

The 280th Combat Communications Squadron provides communications and information systems for command and control of SOF worldwide, as well as responds to state emergencies as directed by the governor.

### ***6th Special Operations Squadron***

The 6 SOS is AFSOC's active duty CAA squadron conducting aviation foreign internal defense. The unit moved to Duke Field, Florida, in May 2013. Its mission is to assess, train, advise and assist foreign aviation units in special operations airpower employment, sustainment and force integration. When required, it executes operations directly employing inherent tactical skills. It also employs the C-145A Skytruck in direct support to U.S. SOF. See the CAA section for more information.

### ***United States Air Force Special Operations School (USAF-SOS)***

The U.S. Air Force Special Operations School is AFSOC's formal school conducting special operations education and professional development. The school develops, schedules, and executes joint education for up to 7,000 students annually. It implements AFSOC Commander and CDRUSSOCOM educational strategy. USAFSOS conducts resident and off-station courses in joint/combined special operations, SOF command and control, cultural/geopolitical regional orientation, COIN, IW, force protection, and language training. With respect to language training USAFSOS provides foreign language initial-acquisition training and language sustainment and enhancement programs to meet the linguistic proficiency required of our Airmen employed in the areas of FID, regional affairs training, and tactical operations

### ***18th Flight Test Squadron***

Air Force Special Operations Command's independent field test agency. The 18th Flight Test Squadron determines the operational effectiveness and suitability of aircraft, equipment and tactics. Conducts force development and evaluation, tactics development and

evaluations, operational utility evaluation, operational assessment, advanced technology demonstration and supports Air Force Test and Evaluation Center's conduct of operational test and evaluation. Provides accurate and timely information and recommendations to the AFSOC commander for acquisition and implementation decisions, ultimately improving the survivability and combat capability of SOF worldwide.

### ***209th Civil Engineer Squadron***

The 209th Civil Engineer Squadron is a Mississippi-based AFSOC-gained Air National Guard unit. It is the Air Force's pilot unit for the AFSOC unique collectively protected small shelter systems (CPSSS-3) and the high mobility decontamination system (HMDS) UTC's, providing specially trained civil engineer teams to set-up, maintain and operate these systems. Through its fire & emergency services flight, it provides fire protection and management, incident command and operations teams in support of U.S. Air Force operations worldwide. The 209th's senior leadership teams support planning and crisis operations for theater headquarters, JTFs, and contingency operating locations.

### ***Language Center***

The Language Center (LC) provides foreign language initial acquisition training (IAT) and language sustainment and enhancement training (SET) to meet the linguistic proficiency required of our Airmen employed in the areas of FID, theater engagement training, and tactical operations.

### ***Training Opportunities***

The LC seeks to provide to our Airmen and civilians the most professional and flexible training possible through a combination of training opportunities. Students have an opportunity to obtain real-time instruction with faculty members from either our Defense Language Institute instructors or our contracted instructors. Although, the majority of training is provided to those already in language-coded billets or in the CAA training pipeline, we also provide materials and training opportunities to a larger audience within our base community. Airmen and civilians with some language capability or deploying personnel now have a chance to use our resources pending

the availability of instructors. CAA students attend IAT on a variety of languages. These students attend class for 6 to 6.5 hours per day for 15 weeks (Category I/ II languages), for 24 weeks (Category III languages), and for 29 weeks (Category IV languages). IAT is also open to other Airmen in language-coded billets.

# Chapter 6. U.S. Marine Corps Special Operations Forces

## Marine Corps Forces Special Operations Command (MARSOC)

At the time of publication, all MARSOC unit titles were correct. Guidance from Headquarters Marine Corps has been issued to regimental, group, and battalion level commands throughout MARSOC to include "Raider" in their official titles. Ceremonies will be conducted throughout 2015 to officially rename the appropriate units.

In October 2005 the Secretary of Defense directed the Marine Corps to form a service component of USSOCOM and begin providing forces to the CDRUSSOCOM. Formally established 24 February 2006, MARSOC's initial manpower authorization is approximately 2,600 Marines, Sailors and civilian employees. Continuous reassessment of operational requirements ensures the command maintains the appropriate capability and capacity.

Headquartered at Camp Lejeune, North Carolina, the U.S. Marine Corps Forces, Special Operations Command (MARSOC) is the Marine Corps component of USSOCOM. MARSOC trains, organizes, equips, and, when directed by the CDRUSSOCOM, provides task-organized, Marine Corps SOF (MARSOF) worldwide in support of combatant commanders and other agencies. MARSOC elements can create strategic impact because they are armed with regionally focused

language skills, cultural understanding, and state-of-the-art equipment. These MARSOF provide a level of capability and understanding necessary for solving complex problems that are not always military in nature.

MARSOC includes three subordinate commands: the Marine Special Operations Regiment (MSOR), the Marine Special Operations Support Group (MSOSG), and the Marine Special Operations School (MSOS). A Marine Corps major general commands MARSOC with a supporting staff designed to be compatible in all functional areas within USSOCOM and Headquarters Marine Corps. The MARSOC headquarters is responsible for identifying Marine special operations-unique requirements; developing MARSOF tactics, techniques, procedures and doctrine; and executing assigned missions in accordance with designated conditions and standards.

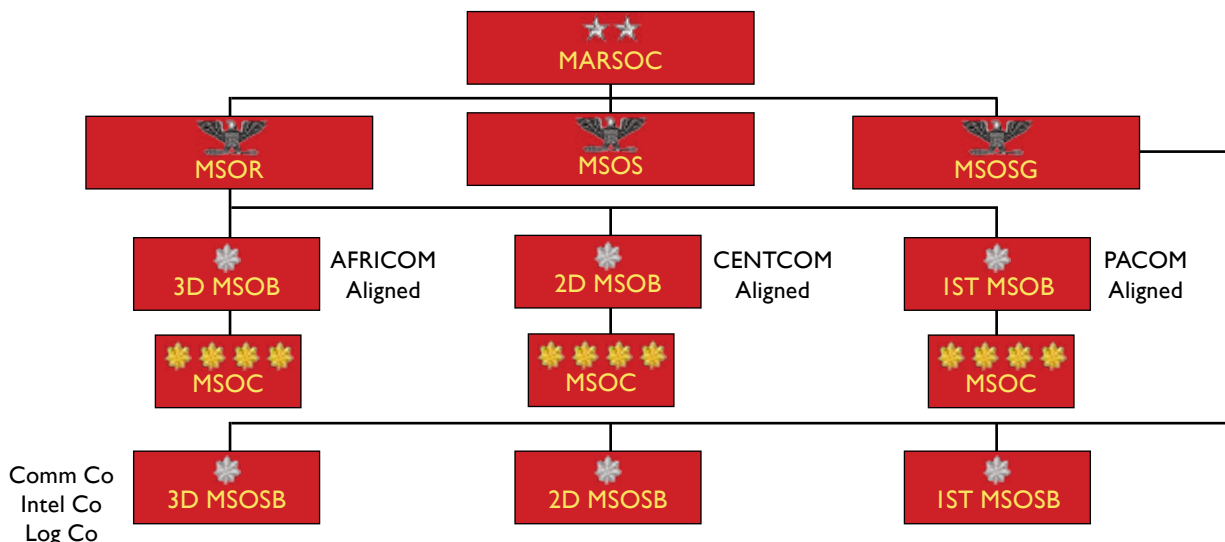

Figure 6-1. MARSOC Organizational and Regional Alignment

**MARSOC Chain of Command.** MARSOC is an assigned force to USSOCOM, the MARSOC commander (COM-MARFORSOC) reports directly to CDRUSSOCOM. COMMARFORSOC exercises OPCON (delegated by CDRUSSOCOM) of all U.S. based MARSOF and ADCON over all MARSOF in accordance with CDRUSSOCOM and Commandant of the U.S. Marine Corps (CMC) guidance. For Marine Corps-specific administrative and other matters, COMMARFORSOC reports directly to CMC. COMMARFORSOC develops the program objective memorandum (POM) and budget estimate submission (BES) for CDRUSSOCOM (MFP-11) and Marine Corps (MFP-2) and ensures adherence to Marine Corps special-interest items.

**Mission.** MARSOC recruits, organizes, trains, equips, and deploys task-organized, scalable, expeditionary Marine Corps Special Operations Forces worldwide to accomplish special operations missions assigned by the CDRUSSOCOM and/or GCCs via the TSOCS.

CDRUSSOCOM has assigned COMMARFORSOC the following SOF Core Activities:

- a. Direct action (DA)
- b. Special reconnaissance (SR)
- c. Counterterrorism (CT)
- d. Foreign internal defense (FID)
- e. Security force assistance (SFA)
- f. Counterinsurgency (COIN)
- g. Support to countering weapons of mass destruction
- h. Support to unconventional warfare

Although not assigned specifically, MARSOC will support the other SOF core activities of hostage rescue and recovery (HRR), foreign humanitarian assistance (FHA), military information support operations (MISO), and civil affairs operations (CAO) as required.

### **MARSOC Personnel**

A direct task within the MARSOC mission is to recruit personnel from within the Marine Corps for service with MARSOC. All combat and combat support personnel in MARSOC are recruited and screened. MARSOC recruits exclusively from within the Marine Corps and not directly from the civilian population. Recruiting from within a pool of trained, mature

Marines allows MARSOC to focus on advanced training and build on the strategic awareness and Marine air-ground task force (MAGTF) concepts common to all experienced Marines. Team cohesion and expertise are integral to success in any special operations force and can only be built over time. MARSOC is responsible for recruiting and screening appropriate personnel for service in three groups: special operations officer (SOO), critical skills operators (CSO), and special operations capabilities specialist (SOCS).

#### ***Special Operations Officer (SOO)***

Officers assigned to lead a Marine special operations team (MSOT) attend both assessment and selection (A&S) and the individual training course (ITC) alongside the CSO candidates. Upon graduation from ITC, they are awarded the 0370 Primary MOS and attend the Team Commander Course. SOOs are then assigned to an MSOB for initial service as team commanders and other SOF billets as they continue to serve as Marine officers in the special operations community. As a SOO's career progresses the billets demand greater responsibility: assignments include billets at a MSOC, MSOB, the MSOR, MSOS, MARSOC HQ and SOF billets external to the component.

#### ***Critical Skills Operator (CSO)***

MARSOC critical skills operators are the backbone of Marine SOF. These Marines undergo a rigorous A&S process followed by extensive individual training to prepare them for the full range of special operations missions. CSOs are trained, organized, and equipped to accomplish special operations in diverse environments, under arduous conditions, and with varying degrees of political sensitivity. Methods of insertion and extraction include surface and subsurface platforms, fixed-wing and vertical-lift aircraft, and ground mobility platforms. MARSOF are highly skilled in FID, direct action, and special reconnaissance missions to include the combat advising of friendly military and/or other forces. While trained to operate in all environments and conditions, MARSOF conduct mission-specific training and preparation that focus on the conditions and threat anticipated in a given area of operations. All CSOs are trained to conduct the full range of special operations activities assigned to MARSOC. CSOs are trained to certain specialty skills resident in each team:

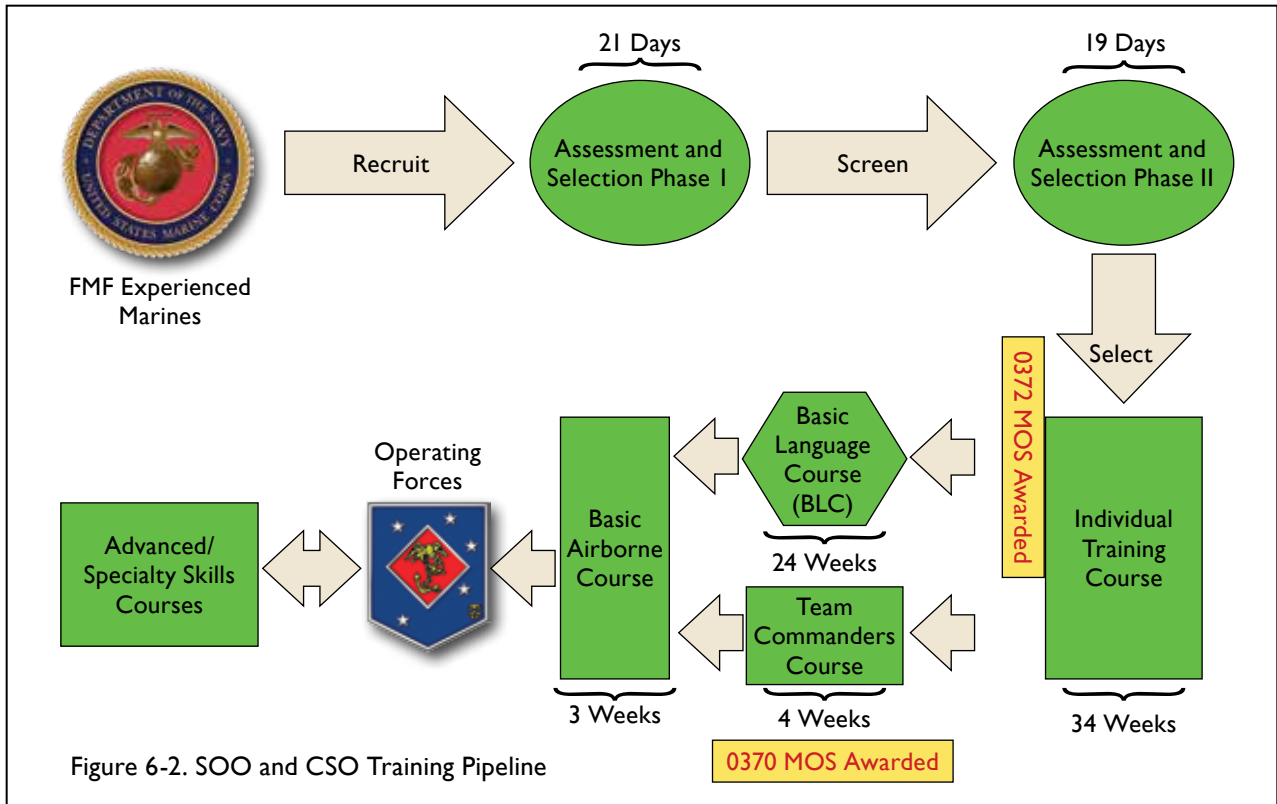

Figure 6-2. SOO and CSO Training Pipeline

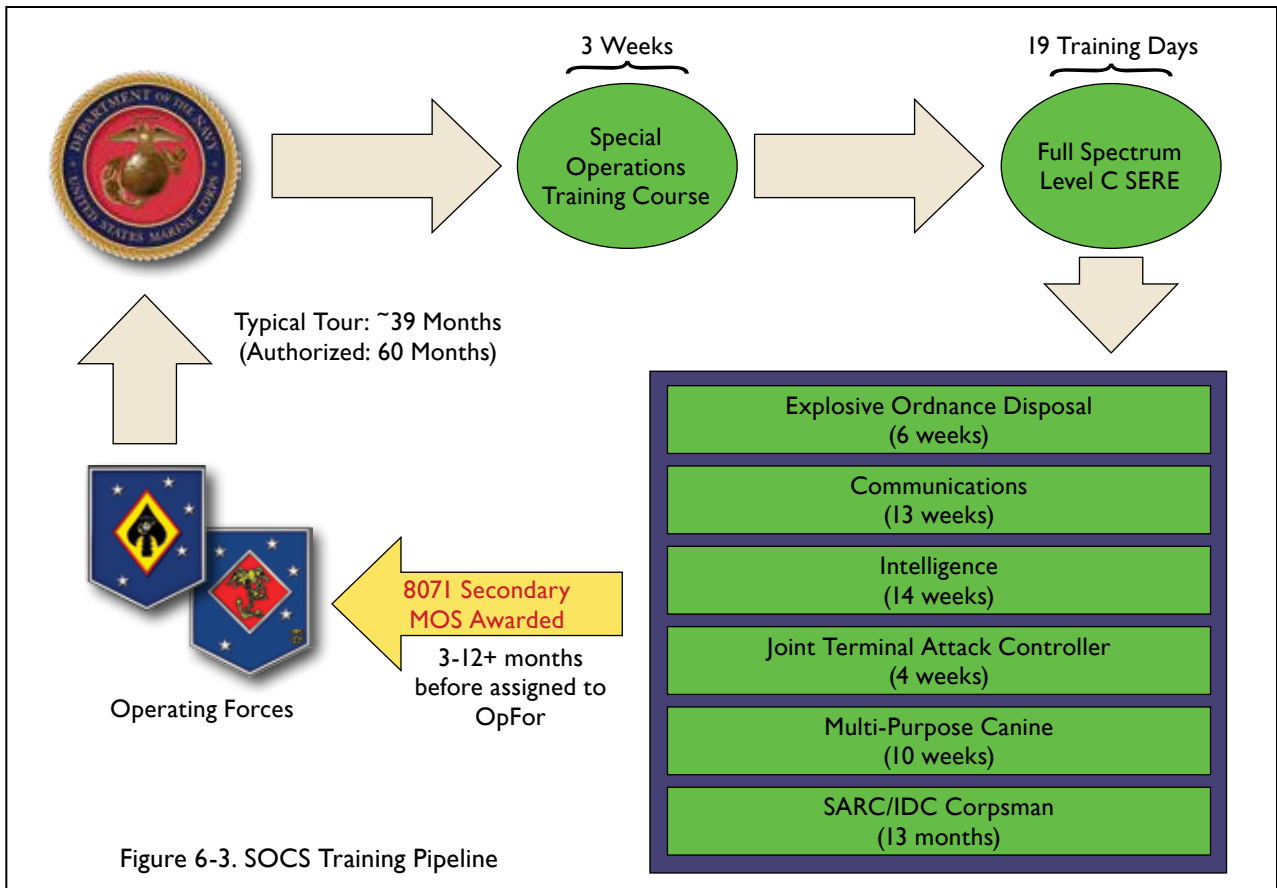

Figure 6-3. SOCS Training Pipeline

- a. Intelligence operations (to include sensitive site exploitation)
- b. Special reconnaissance (to include technical surveillance operations and exploitation)
- c. Weapons employment (to include breaching, sniping, and joint fires)
- d. Communications (voice/data transmission across multiple pathways and networking)
- e. Limited engineering (mobility, counter-mobility, and survivability)
- f. Aviation and airborne operations (air assault/support, static line, free-fall)
- g. Dive/amphibious operations (open and closed circuit diving, small boat coxswain)
- h. Ground mobility (advanced driving and basic mechanic skills)
- i. Regional expertise (to include specific language and cultural training)
- j. Environmental skills (e.g., military mountaineering and jungle warfare)

### Special Operations Capabilities Specialist (SOCS)

SOCS are those Marines who have specific skills in areas including intelligence, communications, fire support, explosive ordnance disposal, and multipurpose canine teams. They frequently deploy alongside Marine special operations teams and companies, and

most DCS personnel must meet the same screening requirements as CSOs, and receive an appropriate level of SOF related training.

### Combat Service Support (CSS)

CSS personnel are Marines who fill administrative and logistics billets in support of special operations companies (MSOC) and battalions (MSOB). These billets can range across the CSS functional areas, from fiscal and administrative clerks to ammunition and supply technicians, specialized medical and engineer support, and various maintenance specialties. CSS Marines are screened based upon the requirements of their individual specialty.

### MARSOC Command and Control

The range of operations assigned to MARSOF requires a high level of flexibility and the ability to operate within the various command structures. MARSOF can work unilaterally under the MSOR, as part of a JSOTF, as a SOTF or as part of a Marine Corps component of a JTF.

**Concept of Employment.** MARSOF are instilled with the Marine Corps' integrative approach to building task-organized forces, as seen in MAGTFs, and a historical familiarity with the amphibious and littoral operating

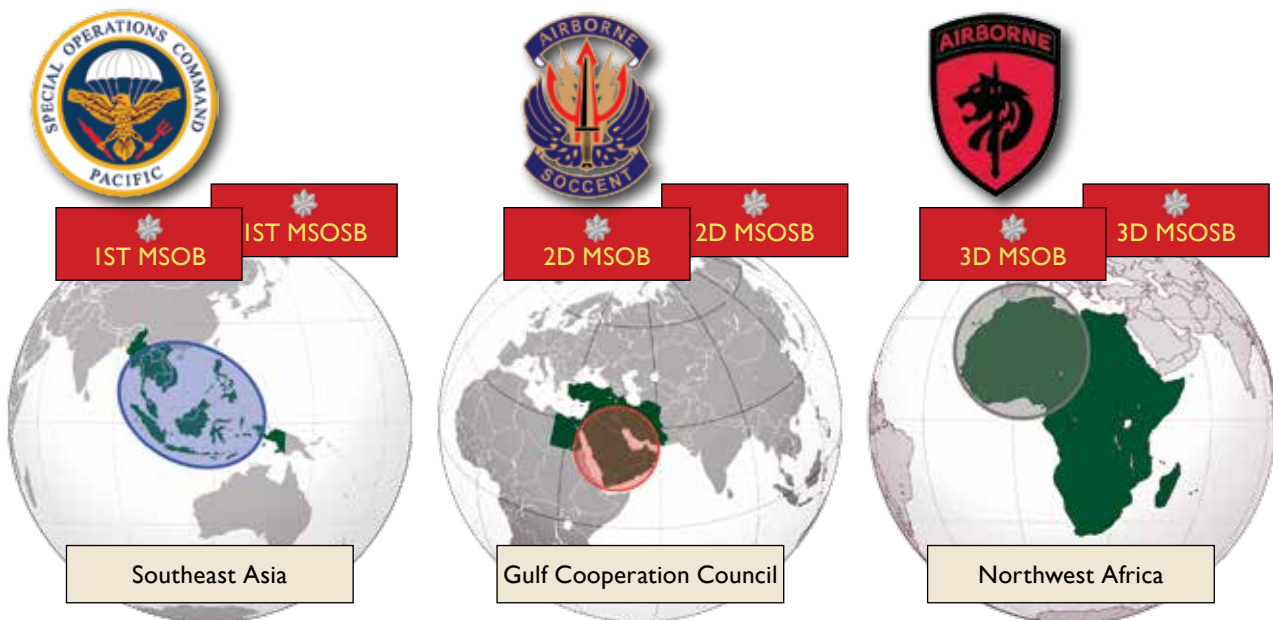

Figure 6-4. Depiction of the MSOB Regional Alignment

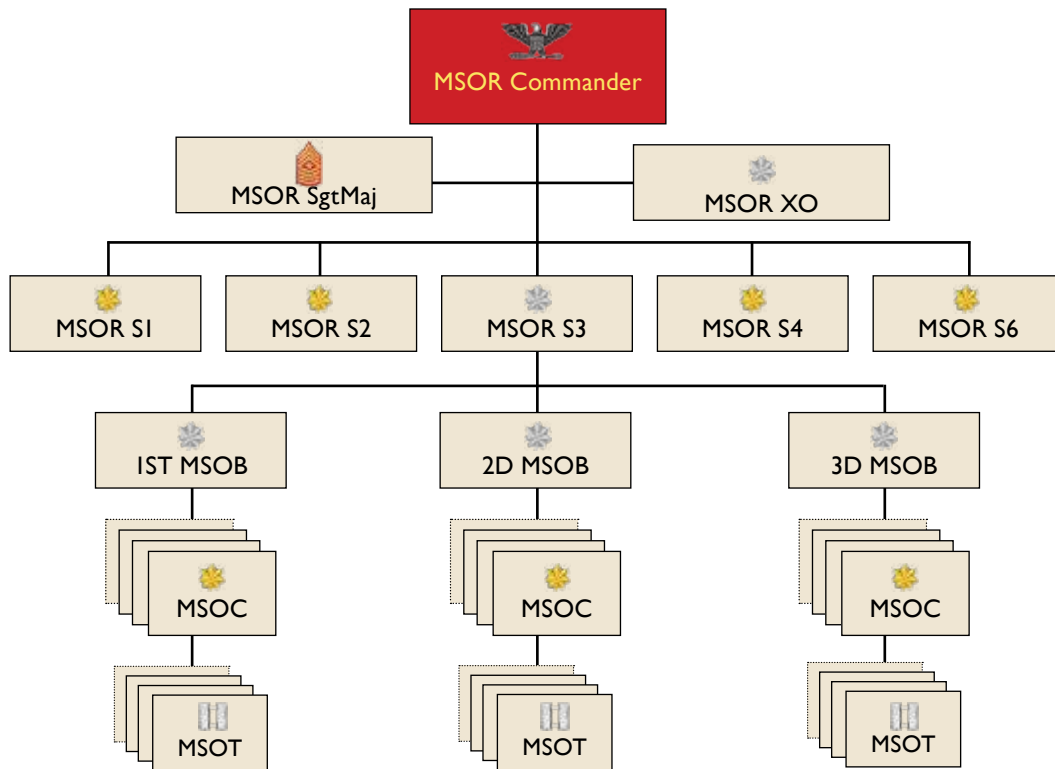

Figure 6-5. MSOR Task Organization

environments. MARSOC’s “small wars” heritage and MAGTF mentality drive emphasis on well-developed intelligence, gained by employing all-source intelligence professionals down to the team level, while supporting robust C2 capabilities at all levels. This makes MARSOC well-suited for SFA, FID, and COIN missions supported by related core activities and tasks.

The enabled MSOC is task organized to meet TSOC requirements. The force composition includes an enabled command and control element that leads a cohesive MSOC that is deployed to support TSOC missions. The enabled capabilities of the MSOC include a fused intelligence section with capabilities organic to the smallest SOF element supported by a robust communications capability and architecture that provides redundant networks to both higher and lateral units. The assigned logistics element ensures sustained support in the most austere environments. This concept of employment allows the MSOC to operate across the full spectrum of special operations.

## MARSOC Units

### Marine Special Operations Regiment (MSOR)

The MSOR is located at Camp Lejeune, North Carolina, and consists of a headquarters company and three MSOBs. The MSOR, which is led by a Marine Corps colonel, provides tailored military combat-skills training and advisor support for identified foreign forces in order to enhance their tactical capabilities and to prepare the environment as directed by USSOCOM, as well as the capability to form the nucleus of a JSOTF. Marines and Sailors of the MSOR train, advise, and assist friendly HN forces—including naval and maritime military and paramilitary forces—to enable them to support their governments’ internal security and stability, to counter subversion, and to reduce the risk of violence from internal and external threats. MSOR deployments are coordinated by MARSOC, through USSOCOM, in accordance with engagement priorities for overseas contingency operations.

**Equipment.** The MSOR employs a combination of SOF peculiar and service common equipment utilized by



the subordinate units during the conduct of SOF missions and tasks. This wide array of equipment supports capability in: insertion/extraction, weapons/optics, communications, logistics, mobility (air, land, and sea), and supporting skills required equipment (JTAC, EOD, medical, MPC, UAS).

#### ***Marine Special Operations Battalion (MSOB)***

There are three MSOBs within the MSOR. They are 1st MSOB, located at Camp Pendleton, California; and 2d and 3d MSOB, which are both located at Camp Lejeune, North Carolina. Each MSOB is commanded by a Marine Corps lieutenant colonel and organized, trained, and equipped to deploy for worldwide missions as directed by MARSOC. MSOBs are composed of MSOCs and task-organized with personnel uniquely skilled in special equipment support, intelligence and fire-support.

#### ***Marine Special Operations Company (MSOC)***

The MSOC is commanded by a Marine Corps major and capable of deploying task-organized expeditionary

SOF to conduct operations in support of the GCCs. When deployed, each MSOC is augmented with a direct intelligence support and enabler capability. The enabling capabilities include a vast array of support ranging from EOD to MPC handlers. This enabling package and direct intelligence support provides a tremendous level of capability to commanders at the tactical level and makes the MSOC a complete operations and intelligence integrated package.

***The Enabled MSOC.*** The *enabled* MSOC is task organized to meet TSOC requirements. The force composition includes a fully enabled command and control element that leads a cohesive MSOC this is trained and certified to support TSOC missions. The enabled capabilities of the MSOC include a fused intelligence section with capabilities organic to the smallest SOF element supported by a robust communications capability and architecture that provides redundant networks to both higher and lateral units. The assigned logistics element ensures sustained support in the most austere



Members of 1st Marine Special Operations Battalion practice breaching on board ship at night. Marines train for Visit, Board, Search and Seizure (VBSS) at the highest level. This type of interdiction involves a non-compliant ship, underway, opposed, and at night.



Figure 6-6. Depiction of the Enabled MSOC

environments. This concept of employment allows the MSOC to operate across the full spectrum of special operations.

Some of the unique support capabilities organic to the MSOC based upon mission analysis may include:

**Explosive Ordnance Disposal (EOD)**

- a. EOD technicians assigned to MARSOC are organic to the MSOBs.
- b. Specially screened and trained Marine EOD technicians serve in support of MARSOCs core activities.

- c. The EOD technicians play a key role in pre-deployment training, supporting current operations, and preparing for future operations.
- d. EOD technicians in support of MARSOC operations provide necessary defeat the device capability and play a critical role in attack the network operations.

**Joint Terminal Attack Controller (JTAC)**

- a. Plan, request, and control conventional and SOF strike assets.



A critical skills operator with U.S. Marine Corps Forces Special Operations Command, emerges from the water during a maritime infiltration training exercise.

- b. Coordinate assault support and casualty evacuation.
- c. Integrate airborne ISR.

#### Multi-Purpose Canine (MPC)

- a. Lethal attack.
- b. Human and explosive detection.
- c. Tracking.
- d. Method of Control: On leash or off leash (300-500m).

#### Command, Control, Communications, and Computers Support Team (C4ST)

- a. Command, control, communications, and computers (C4) support team (C4ST) mission: plan, install, operate, maintain, protect and configure wideband voice, video, and data networks in support of MSOC HQ and area C4 requirements. The C4ST deploys with an SDN-M, which provides the MSOC with all data based services to include NIPR, SIPR, JWICS and access to NSANet.
- b. Each C4ST contains four C4 support elements (C4SEs). Each is composed of one SOCS-C with a wideband satellite network system SDN-L(VX/V3B) which provides the MSOT with data

services that include NIPR and SIPR and when coupled with the Silent Dagger, JWICS and NSANet.

- c. C4SE mission: plan, install, operate, maintain, protect, and configure wideband, voice, video, and data networks in support of MSOT HQ and area C4 requirements.

#### Direct Support Team (DST)

- a. The direct support team (DST) is the primary intelligence support unit within MARSOC and is tasked-organized to provide the supported commander with true all-source fused intelligence. All-source analysts enable the commanders using advanced analytic techniques fed by information from external collection and national databases, and organic signals intelligence; counterintelligence/human intelligence; geospatial intelligence, and operationally derived collection.
- b. The DST is capable of splitting into direct support elements (DSE) to provide cross-functional, integrated intelligence collection and support down to the lowest tactical level.
- c. The success of the DST is that all MARSOC intelligence professionals are experienced analysts and collectors with deployment experience before they ever arrive here because they are hand selected by MARSOC leadership from the broader Marine Corps intelligence pool. On arrival, and before they can deploy with MARSOF, they are certified via SOF level 1 training that revolves around a multi-disciplined intelligence operators course. This course cross trains every collector and analyst in the basic skills for each intelligence field to enhance interoperability, and then provides advanced training in their specific field. The end state is a SOF Intelligence Marine who can enable SOF missions and support GCC requirements throughout the globe.

**Marine Special Operations Team (MSOT)**

MSOTs are the smallest operational element in MARSOC and all MARSOF capabilities begin with this “base element.” All MSOTs are small, highly trained teams capable of independent operations but the additional training of individuals within each team provides advanced capabilities specific to the operation that MSOT has been aligned against. The MSOT includes additional advanced skills in specific areas that further enhance the capability of the team. Typically a MSOT will maintain advanced proficiency in engineering, weapons, operations/intelligence, communications, and MARSOF IDC or SOCS



Figure 6-7. MSOT Composition

J Corpsmen. By design an MSOT can operate as two separate elements geographically dispersed for limited periods supported by the MSOC.

**Marine Special Operations Support Group (MSOSG)**

The MSOSG is a MARSOC subordinate command located at Camp Lejeune, North Carolina. The MSOSG is commanded by a command-selected Marine colonel. The MSOSG maintains habitual supporting relationships between the support battalions and the battalions within the MSOR. MSOSG’s support battalions house the various functional teams tasked to support special operations requirements, providing MARSOC the span of organic support capabilities that make the component unique. Through its subordinate units, MSOSG provides general support (GS), direct support (DS), CS and CSS support to MARSOC and its subordinate units.

**Mission.** MSOSG trains, sustains, maintains combat readiness, and deploys specially qualified Marine CS and CSS forces to support MARSOF worldwide and provide garrison functions for MARSOC.

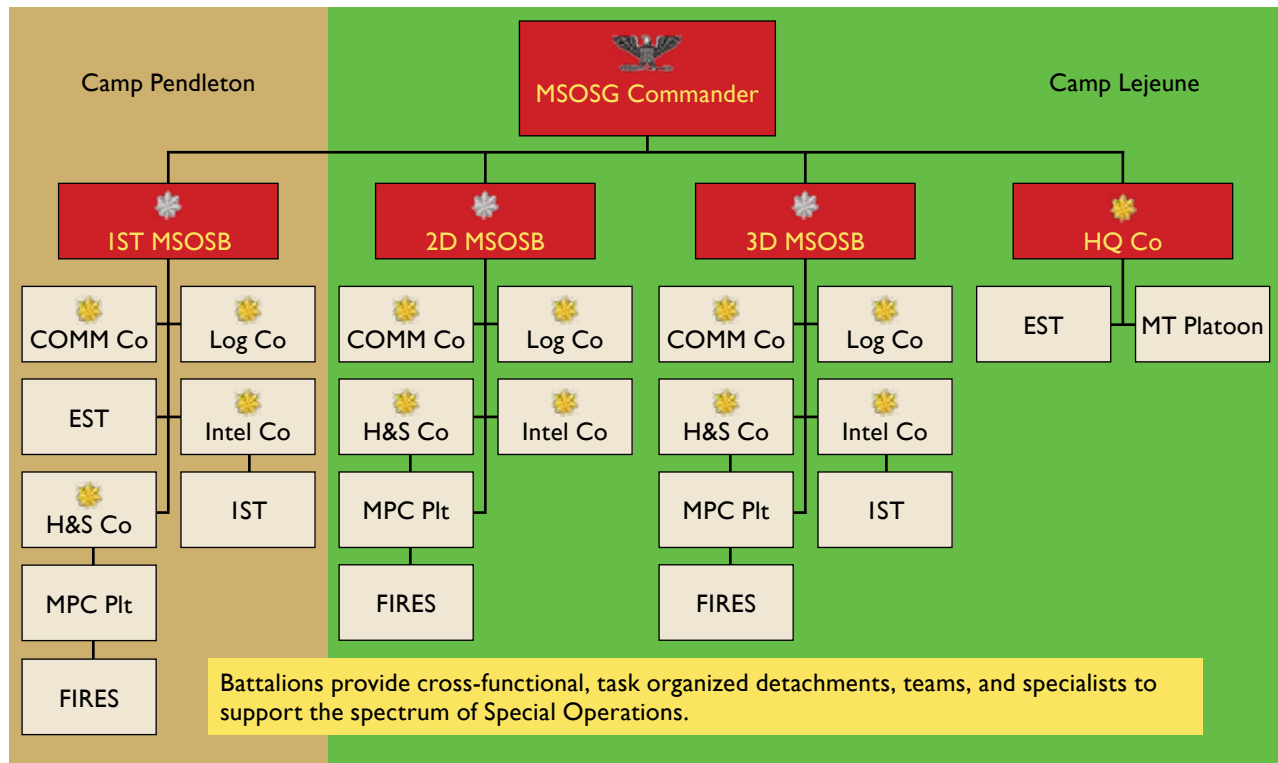

Battalions provide cross-functional, task organized detachments, teams, and specialists to support the spectrum of Special Operations.

Figure 6-8. MSOSG Organization

### ***Marine Special Operations Support Battalion (MSOSB)***

**Mission and Tasks.** MSOSBs train, sustain, maintain combat readiness, and perform change of operational control (CHOP) for deployment of specially qualified Marine CS and CSS functions in support of special operations worldwide.

**Organization.** The support battalions are MSOSG subordinate commands located at Camp Lejeune, North Carolina, and Camp Pendleton, California. The battalions are commanded by a command-selected Marine lieutenant colonel. Support battalions contain H&S, communications, intelligence, and logistics companies. Each of these companies host functionally aligned teams trained to support special operations requirements, and habitually aligned to an associated MSOB.

**Marine Special Operations Communications Company Organization.** The communications companies maintain three C4STs and the appropriate array of communication sets to support a SOTF or SOC-FWD. These teams are trained to address the span of tactical communications, to include data and high-bandwidth communications.

**Marine Special Operations Intelligence Company Organization.** The intelligence companies maintain an intelligence support team (IST) and three DSTs. These teams are composed of multi-discipline intelligence personnel.

The IST is specifically configured to provide intelligence support at a SOTF or SOC-FWD. The DST is the smallest intelligence support unit and is specifically configured to provide intelligence support at the MSOC-level. Although organized for support at the company level, the DST is able to sub-divide into smaller DSEs to provide intelligence support down to the MSOT level.

**Marine Special Operations Logistics Company Organization.** The logistics companies maintain three logistics support teams (LSTs). These teams are assigned in support of deploying MSOCs to provide organic general combat service support.

### ***Marine Special Operations School (MSOS)***

The MSOS is a MARSOC subordinate command located at Camp Lejeune, North Carolina. The MSOS is commanded by a command-selected Marine colonel. The MSOS Commander exercises OPCON and

ADCON of subordinate commanders and assigned forces for COMMARFORSOC.

The mission of MSOS is to assess and select personnel for assignment to MARSOC and to train and educate designated personnel in individual, basic, and advanced special operations in order to meet MARSOC's requirement for global tasking.

MSOS is tasked to:

- a. Conduct individual and basic training.
- b. Conduct advanced special operations training.
- c. Conduct language and cultural training.
- d. Introduce and reinforce Preservation Of The Force and Family (POTFF).
- e. Coordinate, via component, with Joint Special Operations University and Training and Education Command for higher level and service training and education.
- f. As the component lead, develop and introduce special operations tactics, techniques and procedures in coordination with component, MSOR and MSOSG.
- g. As the component lead, develop, evaluate and validate requirements for individual weapons, optics and other equipment in coordination with component G-3 and G-8.
- h. Perform required curriculum review and updates of training material for all assigned courses.

### ***Assessment and Selection***

The MARSOC A&S process varies for each Marine depending on their specific MOS. Each MOS screens their Marines according to their standards and qualifications. A&S for SOOs and CSOs is structured to determine whether or not a candidate has the necessary attributes to successfully complete SOF entry level training and follow on assignment to an operational unit.

A&S is competitive and selective. Both SOOs and CSOs must be complex problem solvers who are comfortable working in an ambiguous environment. MARSOC recruiters provide potential candidates with a recommended training guide designed to physically prepare them for the rigors of the selection process but it is the applicant's responsibility to ensure that they are prepared

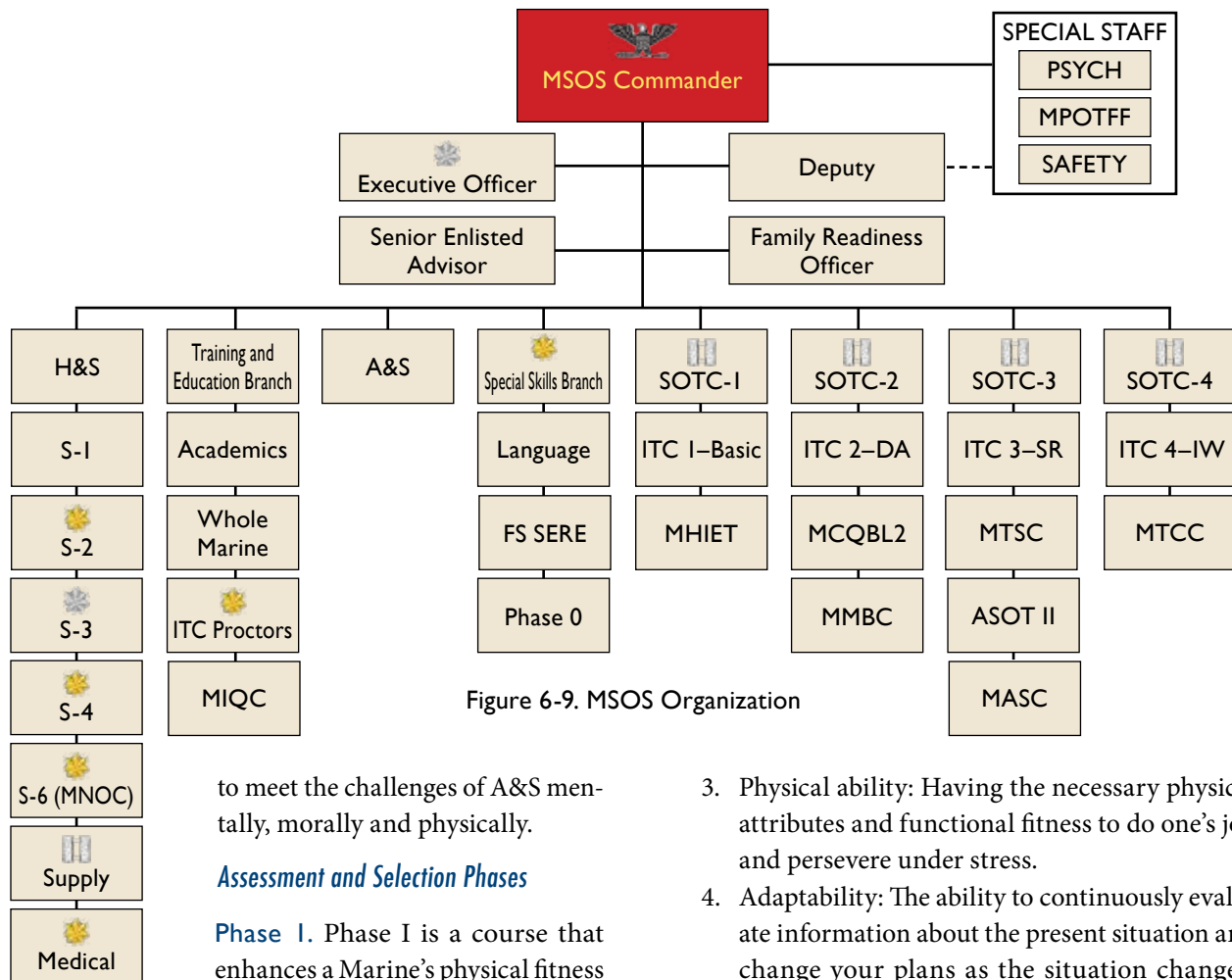

Figure 6-9. MSOS Organization

to meet the challenges of A&S mentally, morally and physically.

#### *Assessment and Selection Phases*

**Phase I.** Phase I is a course that enhances a Marine's physical fitness capabilities, provides education on the culture within, and missions assigned to MARSOC, and prepares Marines for further assessment during Phase II of the program.

**Phase 2.** MARSOC focuses on 10 key attributes during SOO/CSO assessment. It is this combination of all 10 attributes that embodies the type of Marine who will succeed at the ITC and as a future SOO/ CSO. No single attribute carries more weight than another during this process.

MARSOC assesses candidates in individual and team events to ensure they possess the desired attributes that are required of a SOO or CSO. The 10 attributes are:

1. Integrity: Does the right thing even when no one is watching.
2. Effective intelligence: The ability to solve practical problems when a "book solution" is not available. Learn and apply new skills to unusual problems by making sound and timely decisions.
3. Physical ability: Having the necessary physical attributes and functional fitness to do one's job and persevere under stress.
4. Adaptability: The ability to continuously evaluate information about the present situation and change your plans as the situation changes, always operating within commander's intent.
5. Initiative: Goes beyond the scope of his duties without having to be guided or told what to do.
6. Determination: Individual sustains a high level of effort over long periods of time despite the situation.
7. Dependability: Can be relied on to complete tasks correctly, on time, and without supervision.
8. Teamwork: Working well within a team, large or small.
9. Interpersonal skills: Ability to interact and influence others with a minimum of unnecessary strife or friction.
10. Stress tolerance: Deal with ambiguous, dangerous, high pressure and/or frustrating events while maintaining control of emotion, actions, composure and effectiveness.

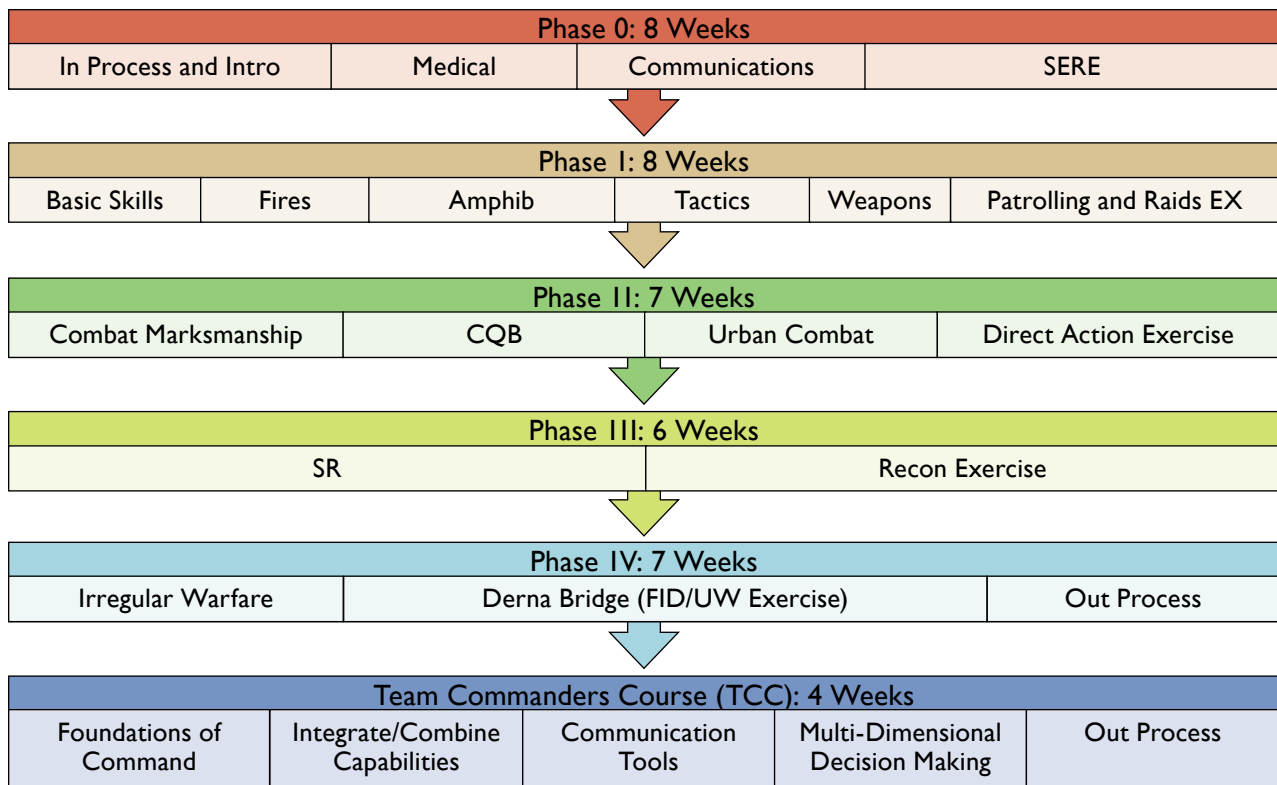

Entry level CSO prepared in priority tasks of FID, IW, DA and SR to join an MSOT

Figure 6-10. Individual Training Course

**Individual Training Course (ITC)**

The ITC is a physically and mentally challenging seven-month course designed to provide MARSOC SOOs and CSOs with a basic foundation of essential special operations skills. The institutional approach at ITC is to develop capable SOOs and CSOs by a process of instruction, practice and evaluation. Skills are continually reinforced by requiring students to apply them under increasingly adverse conditions.

**Language, Regional Expertise, Culture (LREC)**

The combination of language, regional expertise, and culture (LREC) enable operations by allowing MARSOF to speak with foreign partners in their native language. Possessing regional expertise and an appreciation for the culture demonstrate MARSOF's enduring commitment to the mission. The basic language course (BLC) overseen by the special skills branch is an intensive 24 week language acquisition program designed to produce qualified linguists with regional and cultural expertise. BLC currently focuses

on the following MARSOC core languages: Arabic, Indonesian, French (Sub-Saharan), and Tagalog. Future adjustments in MARSOC's regional focus areas will guide additional development of language and cultural training conducted by MSOS.

**Special Operations Training Companies (SOTCs)**

Training at the MSOS is conducted by the SOTCs. The SOTCs are responsible for the execution of specific phases of ITC: tasked with the execution of advanced courses: provide support to SOO, CSO, and SOCS training pipelines. SOTC assignments as it pertains to ITC (depicted in Figure: 3-10) and advanced courses are listed below.

**SOTC-1.** ITC Phase One, MARSOF Helicopter Insertion Extraction Training (MHIET)

**SOTC-2.** ITC Phase Two, MARSOF Master Breacher Course (MMBC), Close Quarters Battle Leaders II Course (CQBL2)

**SOTC-3.** ITC Phase Three, Special Reconnaissance (SR), MARSOF Technical Surveillance Course (MTSC). MARSOF Advanced Sniper Course (MASC). Advanced Special Operations Training Level II (ASOT II)

**SOTC-4.** ITC Phase Four, Team Commanders Course (TCC)

**MARSOC Preservation of the Forces and Family (MPOTFF)**

The MARSOC POTFF (MPOTFF) initiative is developing an organizational culture that exemplifies and supports performance and resilience throughout the command. For any individual, the achievement of this goal rests on four foundational concepts that together constitute the whole person. They are body, mind, spirit, and family. These four components support personal performance in all individuals whether they are Marines, family members, civilian employees or contractors. In order to serve as a basis for exceptional performance and personal resilience, all four components must be firmly established, balanced and

focused on excellence. This foundation of body, mind, spirit, and family will provide the balance and internal strength required to sustain honorable character, high performance and “bounce-back” capability under continuous high demand conditions.

MARSOC balances the many MPOTFF resources by aligning them into “pillars” that facilitate the availability of support to all MARSOC commands at all levels. The MPOTFF pillars are:

- a. Health services
- b. Human performance
- c. Chaplain
- d. Force preservation
- e. Family readiness
- f. Behavioral health

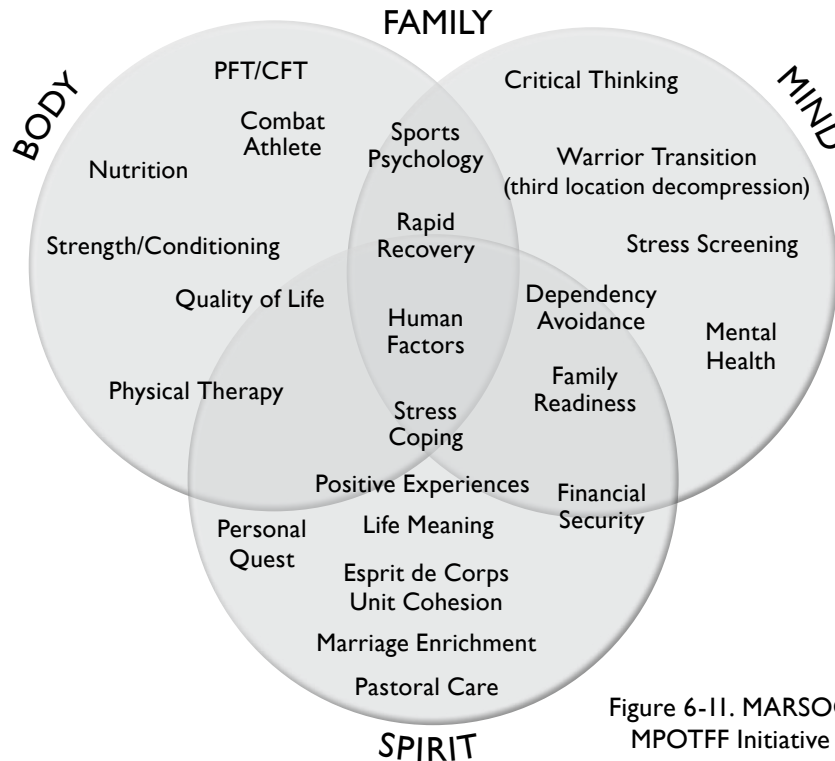

Figure 6-II. MARSOC MPOTFF Initiative





# Appendix A. Special Operations Related Definitions

**AIR FORCE SPECIAL OPERATIONS COMMAND (AFSOC).** AFSOC is the Air Force service component to U.S. Special Operations Command.

**AIR FORCE SPECIAL OPERATIONS FORCES (AFSOF).** Those active and reserve component Air Force forces designated by the SecDef that are specifically organized, trained, and equipped to conduct and support special operations.

**AMBASSADOR.** A diplomatic agent of the highest rank accredited to a foreign government or sovereign as the resident representative of his own government, also called the Chief of Mission. In the U.S. system, the Ambassador is the personal representative of the President and reports to him through the Secretary of State.

**ANTITERRORISM (AT).** Defensive measures used to reduce the vulnerability of individuals and property to terrorist acts, to include rapid containment by local military and civilian forces.

**AREA ASSESSMENT.** The commander's prescribed collection of specific information that commences upon employment and is a continuous operation. It confirms, corrects, refutes, or adds to previous intelligence acquired from area studies and other sources prior to employment.

**ARMY SPECIAL OPERATIONS COMMAND (ARSOC).** ARSOC is a specific term, which may be used to refer to the Army component of a joint special operations command or task force.

**ARMY SPECIAL OPERATIONS FORCES (ARSOF).** Those active and reserve component Army forces designated by the SecDef that are specifically organized, trained, and equipped to conduct and support special operations.

**ASSET (Intelligence) (DOD, IADB).** Any resource, person, group relationship, instrument, installation, or supply at the disposition of an intelligence organization for use in an operational or support role. Often

used with a qualifying term such as agent asset or propaganda asset.

**ATTACHE.** A person attached to the Embassy in a diplomatic status who is not normally a career member of the diplomatic service. In the U.S. system, attachés generally represent agencies other than the Department of State, (i.e., DOD, USAID, FBI, Department of Justice).

**BARE BASE (Air Operations).** A base having minimum essential facilities to house, sustain, and support operations to include, if required, a stabilized runway, taxiways, and aircraft parking areas. A bare base must have a source of water that can be made potable. Other requirements to operate under bare base conditions form a necessary part of the force package deployed to the bare base.

**CAPABILITY.** The ability to execute a specified course of action.

**CELL.** Small group of individuals who work together for a clandestine or subversive purpose and whose identity is unknown by members of other cells within the overall organization.

**CHARGÉ D'AFFAIRES.** An Embassy official (normally the Deputy Chief of Mission or second highest-ranking officer), who takes charge of the mission in the absence of the Ambassador.

**CHIEF OF MISSION (COM).** The principal officer (the Ambassador) in charge of a diplomatic facility of the United States, including any individual assigned to be temporarily in charge of such a facility. The chief of mission is the personal representative of the President to the country of accreditation. The chief of mission is responsible for the direction, coordination, and supervision of all U.S. Government executive branch employees in that country (except those under the command of a U.S. area military commander). The security of the diplomatic post is the chief of mission's direct responsibility.

**CHIEF OF STATION (COS).** The senior United States intelligence officer in a foreign country and the direct representative of the Director National Intelligence, to whom the officer reports through the Director Central Intelligence Agency. Usually the senior representative of the Central Intelligence Agency assigned to a U.S. mission.

**CIVIL ADMINISTRATION.** An administration established by a foreign government in 1) friendly territory under an agreement with the government of the area to exercise certain authority normally the function of the local government; or 2) hostile territory occupied by United States forces, where a foreign government exercises executive, legislative, and judicial authority until an indigenous civil government can be established.

**CIVIL AFFAIRS (CA).** Designated active and reserve component forces and units organized, trained, and equipped specifically to conduct CA activities and to support civil-military operations.

**CIVIL AFFAIRS OPERATIONS (CAO).** Actions planned, executed, and assessed by civil affairs forces that enhance awareness of and manage the interaction with the civil component of the operational environment; identify and mitigate underlying causes of instability within civil society; or involve the application of functional specialty skills normally the responsibility of civil government.

**CIVIL-MILITARY OPERATIONS (CMO).** Activities of a commander performed by designated civil affairs or other military forces that establish, maintain, influence, or exploit relations between military forces, indigenous populations, and institutions, by directly supporting the attainment of objectives relating to the reestablishment or maintenance of stability within a region or host nation.

**CLANDESTINE OPERATION.** An operation sponsored or conducted by governmental departments or agencies in such a way as to assure secrecy or concealment. A clandestine operation differs from a covert operation in that emphasis is placed on concealment of the operation rather than the concealment of the identity of the sponsor. In special operations, an activity may be both covert and clandestine and may focus equally on operational considerations and intelligence-related activities.

**COALITION WARFARE.** The combined effort of nations with common strategic interests to coordinate their warfighting capability for defense of those interests.

**COMBAT SEARCH AND RESCUE (CSAR).** The tactics, techniques, and procedures performed by forces to effect the recovery of isolated personnel during combat.

**COMBATING TERRORISM.** Actions, including antiterrorism and counterterrorism, taken to oppose terrorism throughout the entire threat spectrum.

**COMBATANT COMMAND (COCOM).** Nontransferable command authority established by title 10 (Armed Forces), United States Code, section 164, exercised only by commanders of unified or specified commands unless otherwise directed by the President or the SecDef. COCOM authority cannot be delegated and is the authority of a combatant commander to perform those functions of command over assigned forces involving organizing and employing commands and forces, assigning tasks, designating objectives, and giving authoritative direction over all aspects of military operations, joint training, and logistics necessary to accomplish the missions assigned to the command. COCOM should be exercised through commanders of subordinate organizations—normally through subordinate joint force commanders and service and/or functional component commanders. COCOM provides full authority to organize and employ commands and forces as the combatant commander considers necessary to accomplish assigned missions. Operational control is inherent in COCOM.

**COMBINED JOINT SPECIAL OPERATIONS TASK FORCE (CJSOTF).** A task force composed of special operations units from one or more foreign countries and more than one U.S. military department formed to carry out a specific special operation or prosecute special operations in support of a theater campaign or other operations. The CJSOTF may have conventional non-special operations units assigned or attached to support the conduct of specific missions.

**CONSULATE GENERAL/CONSULATE.** A constituent post of an Embassy in a foreign country located in an important city other than the national capital.

Consulates General are larger than Consulates, with more responsibilities and additional staff.

**CONVENTIONAL FORCES.** 1. Those forces capable of conducting operations using nonnuclear weapons. 2. Those forces other than designated SOF.

**COUNTERDRUG.** Those active measures taken to detect, monitor, and counter the production, trafficking, and use of illegal drugs.

**COUNTERINTELLIGENCE (CI).** Information gathered and activities conducted to identify, deceive, exploit, disrupt, or protect against espionage, other intelligence activities, sabotage, or assassinations conducted for or on behalf of foreign powers, organizations or people or their agents, or international terrorist organizations or activities.

**COUNTERMINE OPERATION.** In land mine warfare, an operation to reduce or eliminate the effects of mines or minefields.

**COUNTERPROLIFERATION (CP).** Those actions taken to defeat the threat and/or use of weapons of mass destruction against the United States, our forces, friends, allies, and partners.

**COUNTERTERRORISM (CT).** Actions taken directly against terrorist networks and indirectly to influence and render global and regional environments inhospitable to terrorist networks.

**COUNTRY TEAM.** The senior, in-country, United States coordinating and supervising body, headed by the chief of the United States diplomatic mission, and composed of the senior member of each represented United States department or agency, as desired by the chief of the United States diplomatic mission.

**COVERT OPERATIONS.** An operation that is so planned and executed as to conceal the identity of or permit plausible denial by the sponsor. A covert operation differs from a clandestine operation in that emphasis is placed on the concealment of the identity of the sponsor rather than on concealment of the operation.

**DECEPTION.** Those measures designed to mislead the enemy by manipulation, distortion, or falsification of

evidence to induce him to react in a manner prejudicial to his interests.

**DECONFLICT.** To reconcile or resolve a conflict in interests as in targeting.

**DENIAL MEASURE.** An action to hinder or deny the enemy the use of territory, personnel, or facilities to include destruction, removal, contamination, or erection of obstructions.

**DIRECT ACTION (DA).** Short-duration strikes and other small-scale offensive actions conducted as a special operation in hostile, denied, or diplomatically sensitive environments and which employ specialized military capabilities to seize, destroy, capture, exploit, recover, or damage designated targets. Direct action differs from conventional offensive actions in the level of physical and diplomatic or political risk, operational techniques, and the degree of discriminate and precise use of force to achieve specific objectives.

**ELECTRONIC COUNTER COUNTERMEASURES (ECCM).** That division of electronic warfare involving actions taken to ensure friendly, effective use of the electromagnetic spectrum despite the enemy's use of electronic warfare.

**ELECTRONIC WARFARE (EW).** Any military action involving the use of electromagnetic and directed energy to control the electromagnetic spectrum or to attack the enemy. The three major subdivisions within EW are electronic attack, electronic protection, and electronic warfare support.

- a. **Electronic Attack (EA).** The division of EW involving the use of electromagnetic, directed energy, or antiradiation weapons to attack personnel, facilities, or equipment with the intent of degrading, neutralizing, or destroying enemy combat capability. EA includes: 1. actions taken to prevent or reduce an enemy's effective use of the electromagnetic spectrum, such as jamming and electromagnetic deception, and 2. employment of weapons that use either electromagnetic or directed energy as their primary destructive mechanism (lasers, radio frequency weapons, particle beams).
- b. **Electronic Protection (EP).** The division of electronic warfare involving actions taken to protect

personnel, facilities, and equipment from any effects of friendly or enemy employment of EW that degrade, neutralize, or destroy friendly combat capability.

- c. **Electronic Warfare Support (ES).** Division of electronic warfare involving actions tasked by, or under direct control of, an operational commander to search for, intercept, identify, and locate or localize sources of intentional and unintentional radiated electromagnetic energy for the purpose of immediate threat recognition, targeting, planning and conduct of future operations.

**EMERGENCY RESUPPLY.** A resupply mission that occurs based on a predetermined set of circumstances and time interval should radio contact not be established, or once established, is lost between the main base and between a special operations tactical element and its base.

**ESSENTIAL ELEMENTS OF FRIENDLY INFORMATION (EEFI).** Key questions likely to be asked by adversary officials and intelligence systems about specific friendly intentions, capabilities, and activities, so they can obtain answers critical to their operational effectiveness.

**ESSENTIAL ELEMENTS OF INFORMATION (EEI).** The most critical information requirements regarding the adversary and the environment needed by the commander by a particular time to relate with other available information and intelligence in order to assist in reaching a logical decision.

**EVASION AND ESCAPE (E&E).** The procedures and operations whereby military personnel and other selected individuals are enabled to emerge from an enemy-held or hostile area to areas under friendly control.

**EVASION AND RECOVERY.** The full spectrum of coordinated actions carried out by evaders, recovery forces, and operational recovery planners to effect the successful return of personnel isolated in hostile territory to friendly control.

**EXFILTRATION.** The removal of personnel or units from areas under enemy control.

**FOREIGN INTELLIGENCE.** Information relating to capabilities, intentions, and activities of foreign governments or elements thereof, foreign organizations, or foreign persons, or international terrorist activities.

**FOREIGN INTERNAL DEFENSE (FID).** Participation by civilian and military agencies of a government in any of the action programs taken by another government or other designated organization to free and protect its society from subversion, lawlessness, insurgency, terrorism, and other threats to its security.

**FORWARD ARMING AND REFUELING POINT (FARP).** A temporary facility, organized, equipped, and deployed by an aviation commander and normally located in the main battle area closer to the area of operation than the aviation unit's combat service area, to provide fuel and ammunition necessary for the employment of aviation maneuver units in combat. The FARP permits combat aircraft to rapidly refuel and rearm simultaneously. In special operations, a FARP is often quickly and clandestinely established to support a single operation, frequently in hostile or denied territory. Once its mission is served, it is quickly dismantled, preferably without leaving signs of its presence.

**FORWARD OPERATIONS BASE (FOB).** In special operations, a base usually located in friendly territory or afloat, which is established to extend command and control or communications or to provide support for training and tactical operations. Facilities are usually temporary; they may include an airfield or an unimproved airstrip, an anchorage, or a pier. The FOB may be the location of a special operations component headquarters or a smaller unit that is supported by a main operations base.

**FORWARD OPERATING LOCATION (FOL).** A temporary base of operations for small groups of personnel established near or within the JSOA to support training of indigenous personnel or tactical operations. The FOL may be established to support one or a series of missions. Facilities are austere; they may include an unimproved airstrip, a pier, or an anchorage. A main operational base or a forward operations base may support the FOL.

**HOST NATION (HN).** A nation that receives the forces and/or supplies of allied nations, coalition partners, and/or NATO organizations to be located on, to operate in, or to transit through its territory.

**HOST-NATION SUPPORT (HNS).** Civil and/or military assistance rendered by a nation to foreign forces within its

territory during peacetime, crises or emergencies, or war based on agreements mutually concluded between nations.

**HUMAN INTELLIGENCE (HUMINT).** A category of intelligence derived from information collected and provided by human sources.

**HUMANITARIAN AND CIVIC ASSISTANCE (HCA).** Assistance to the local populace, specifically authorized by Title 10, United States Code, Section 401, and funded under separate authorities, provided by predominantly United States forces in conjunction with military operations.

**INFILTRATION.** a. The movement through or into an area or territory occupied by either friendly or enemy troops or organizations. The movement is made either by small groups or by individuals at extended or irregular intervals. When used in connection with the enemy, it infers that contact is avoided. b. In intelligence usage, placing an agent or other person in a target area in hostile territory. Usually involves crossing a frontier or other guarded line. Methods of infiltration are black (clandestine); gray (through legal crossing point but under false documentation); and white (legal).

**INFORMATION.** a. Facts, data, or instructions in any medium or form. b. The meaning that a human assigns to data by means of the known conventions used in their representation.

**INFORMATION OPERATIONS (IO).** The integrated employment, during military operations, of information-related capabilities in concert with other lines of operation to influence, disrupt, corrupt, or usurp the decision-making of adversaries and potential adversaries while protecting our own.

**INFORMATION WARFARE (IW).** Information operations conducted during time of crisis or conflict to achieve or promote specific objectives over a specific adversary or adversaries.

**INTELLIGENCE REPORTING.** The preparation and conveyance of information by any means. More commonly, the term is restricted to reports as the collector prepares them and as they are transmitted by him to his headquarters and by this component of the intelligence structure to one or more intelligence-producing

components. Thus, even in this limited sense, reporting embraces both collection and dissemination. The term is applied to normal and specialist intelligence reports.

**JOINT CHIEFS OF STAFF (JCS).** Staff within the DOD, which consists of the Chairman, who is the presiding officer but who has no vote; the Chief of Staff, United States Army; the Chief of Naval Operations; the Chief of Staff, United States Air Force; and the Commandant, United States Marine Corps. The Joint Chiefs of Staff are the principal military advisers to the President, the National Security Council, and the SecDef.

**JOINT COMBINED EXCHANGE TRAINING (JCET).** A program conducted overseas to fulfill U.S. forces training requirements and at the same time exchange the sharing of skills between U.S. forces and host nation counterparts.

**JOINT DOCTRINE.** Fundamental principles that guide the employment of United States military forces in coordinated action toward a common objective and may include terms, tactics, techniques, and procedures.

**JOINT FORCE COMMANDER (JFC).** A general term applied to a combatant commander, subunified commander, or a joint task force commander authorized to exercise combatant command (command authority) or operational control over a joint force.

**JOINT FORCE SPECIAL OPERATIONS COMPONENT COMMANDER (JFSOCC).** The commander within a unified command, subordinate unified command, or Joint Task Force responsible to the establishing commander for making recommendations on the proper employment of assigned, attached, and/or made available for tasking SOF and assets; planning and coordinating special operations; or accomplishing such operational missions as may be assigned. The JFSOCC is given the authority necessary for the accomplishment of missions and tasks assigned by the establishing commander.

**JOINT INFORMATION SUPPORT TASK FORCE (SPECIAL OPERATIONS) – JISTF(SO).** Joint Doctrine has yet to address changes in MISO.

**JOINT SPECIAL OPERATIONS AIR COMPONENT COMMANDER (JSOACC).** The commander within a Joint Force Special Operations Command responsible

for planning and executing joint special operations air activities.

**JOINT SPECIAL OPERATIONS AREA (JSOA).** An area of land, sea, and airspace assigned by a Joint Force Commander to the commander of a joint special operations force to conduct special operations activities. It may be limited in size to accommodate a discrete direct action mission or may be extensive enough to allow a continuing broad range of unconventional warfare operations.

**JOINT SPECIAL OPERATIONS TASK FORCE (JSOTF).** A joint task force composed of special operations units from more than one service, formed to carry out a specific special operation or prosecute special operations in support of a theater campaign or other operations. The JSOTF may have conventional non-special operations units assigned or attached to support the conduct of specific missions.

**JOINT TASK FORCE (JTF).** A joint force that is constituted and so designated by the SecDef, a combatant commander, a subunified commander, or an existing JTF commander.

**MAIN OPERATIONS BASE (MOB).** In special operations, a base established by a joint force special operations component commander or a subordinate special operations component commander in friendly territory to provide sustained command and control, administration, and logistic support to special operations activities in designated areas.

**MILITARY CIVIC ACTION.** Programs and projects managed by United States forces but executed primarily by indigenous military or security forces that contribute to the economic and social development of a host nation civil society thereby enhancing the legitimacy and social standing of the host nation government and its military forces.

**MILITARY INFORMATION SUPPORT OPERATIONS (MISO).** Planned operations to convey selected information and indicators to foreign audiences to influence their emotions, motives, objective reasoning, and ultimately the behavior of foreign governments, organizations, groups, and individuals in a manner favorable to the originator's objectives.

**MILITARY INFORMATION SUPPORT OPERATIONS PLANNING AND ADVISORY TEAM (MPAT).** A small, tailored team (approximately four–12 personnel) that consists of military information support operations planners and product distribution/dissemination and logistic specialists. The team is deployed to theater at the request of the combatant commander to assess the situation, develop military information support operations objectives, and recommend the appropriate level of support to accomplish the mission.

**MOBILE SEA BASE.** An afloat base composed of command and barracks facilities, small craft repair shops, and logistics support ships, which provide support as a base of operations from which a sea force can launch and conduct sea warfare.

**MOBILE TRAINING TEAM (MTT).** A team consisting of one or more U.S. military or civilian personnel sent on temporary duty, often to a foreign nation, to give instruction. The mission of the team is to train indigenous personnel to operate, maintain, and employ weapons and support systems, or to develop a self-training capability in a particular skill. The Secretary of Defense may direct a team to train either military or civilian indigenous personnel, depending upon host nation requests.

**NATIONAL COMMAND AUTHORITIES (NCA).** The President and the SecDef or their duly deputized alternates or successors.

**NATIONAL OBJECTIVES.** The aims, derived from national goals and interests, toward which a national policy or strategy is directed and efforts and resources of the nation are applied.

**NATIONAL POLICY.** A broad course of action or statements of guidance adopted by the government at the national level in pursuit of national objectives.

**NATIONAL SECURITY.** A collective term encompassing both national defense and foreign relations of the United States. Specifically, the condition provided by:

- a. A military or defense advantage over any foreign nation or group of nations
- b. A favorable foreign relations position
- c. A defense posture capable of successfully resisting hostile or destructive action from within or without, overt or covert

**NATIONAL STRATEGY.** The art and science of developing and using the political, economic, and psychological powers of a nation, together with its armed forces, during peace and war, to secure national objectives.

**NAVAL SPECIAL OPERATIONS COMMAND (NAVSOC).** NAVSOC is a specific term, which may be used to refer to the Navy component of a joint special operations command or task force.

**NAVAL SPECIAL OPERATIONS FORCES (NAVSOFF).** NAVSOFF is an umbrella term for naval forces that conduct and support special operations.

**NAVAL SPECIAL WARFARE (NSW).** A naval warfare specialty that conducts special operations with an emphasis on maritime, coastal, and riverine environments using small, flexible, mobile units operating under, on, and from the sea.

**NAVAL SPECIAL WARFARE GROUP (NSWG).** A permanent Navy echelon III major command to which most NSW forces are assigned for some operational and all administrative purposes. It consists of a group headquarters with command and control, communications, and support staff; SEAL teams; and SEAL delivery vehicle teams.

**NAVAL SPECIAL WARFARE TASK GROUP (NSWTG).** A provisional NSW organization that plans, conducts, and supports special operations in support of fleet commanders and joint force special operations component commanders.

**NAVAL SPECIAL WARFARE TASK UNIT (NSWTU).** A provisional subordinate unit of a naval special warfare task group.

**OPERATIONAL CONTROL (OPCON).** Command authority that may be exercised by commanders at any echelon at or below the level of combatant command. Operational control is inherent in combatant command (command authority) and may be delegated within the command. Operational control is the authority to perform those functions of command over subordinate forces involving organizing and employing commands and forces, assigning tasks, designating objectives, and giving authoritative direction over all aspects of military operations and joint training necessary to accomplish

missions assigned to the command. Operational control should be exercised through the commanders of subordinate organizations. Normally this authority is exercised through subordinate joint force commanders and service and/or functional component commanders. Operational control normally provides full authority to organize commands and forces and to employ those forces as the commander in operational control considers necessary to accomplish assigned missions; it does not, in and of itself, include authoritative direction for logistics or matters of administration, discipline, internal organization, or unit training.

**PSYCHOLOGICAL OPERATIONS (PSYOP).** NATO still uses the term Psychological Operations. Planned operations to convey selected information and indicators to foreign audiences to influence their emotions, motives, objective reasoning, and ultimately the behavior of foreign governments, organizations, groups, and individuals. The purpose of PSYOP is to induce or reinforce foreign attitudes and behavior favorable to the originator's objectives.

**RAID.** An operation to temporarily seize an area in order to secure information, confuse an adversary, capture personnel or equipment, or destroy a capability culminating with a planned withdrawal.

**RANGERS.** Rapidly deployable airborne light infantry organized and trained to conduct highly complex joint direct action operations in coordination with or in support of other special operations units of all services. Rangers can also execute direct action operations in support of conventional non-special operations missions conducted by a combatant commander and can operate as conventional light infantry when properly augmented with other elements of combined arms.

**SABOTAGE.** An act or acts with intent to injure, interfere with, or obstruct the national defense of a country by willfully injuring or destroying, or attempting to injure or destroy any national defense or war material, premises, or utilities, to include human and natural resources.

**SEA-AIR-LAND (SEAL) TEAM.** U.S. Navy forces organized, trained, and equipped to conduct special operations in maritime, coastal, and riverine environments.



**SEAL TROOP.** An administrative term for CONUS-based Naval Special Warfare subordinate unit of an NSW squadron or SEAL Team. Normally commanded by a SEAL lieutenant commander (O-4), a SEALTP consists of a command and control element, an operational element, and other attachments, e.g., mobility element.

**SEARCH AND RESCUE (SAR).** The use of aircraft, surface craft, submarines, specialized rescue teams, and equipment to search for and rescue distressed persons on land or at sea in a permissive environment.

**SECURITY ASSISTANCE.** Group of programs authorized by the Foreign Assistance Act of 1961, as amended, and the Arms Export Control Act of 1976, as amended, or other related statutes by which the United States provides defense articles, military training, and other defense-related services, by grant, credit, or cash sales, in furtherance of national policies and objectives. Security assistance is an element of security cooperation funded and authorized by Department of State to be administered by Department of Defense/Defense Security Cooperation Agency.

**SECURITY ASSISTANCE ORGANIZATIONS (SAO).** All DOD elements located in a foreign country with assigned responsibilities for carrying out security assistance management functions. It includes military assistance advisory groups, military missions and groups, offices of defense and military cooperation, liaison groups, and defense attaché personnel designated to perform security assistance functions.

**SECURITY FORCE ASSISTANCE (SFA).** DOD activities that contribute to unified action by the USG to support the development of the capacity and capability of foreign security forces and their supporting institutions.

**SENIOR DEFENSE OFFICIAL/DEFENSE ATTACHÉ (SDO/DATT).** U.S. Embassy Chief of Mission's principal military advisor on defense and national security issues, the senior diplomatically accredited DOD military officer assigned to a U.S. diplomatic mission, and the single point of contact for all DOD matters involving the Embassy or DOD elements assigned to or working from the Embassy.

**SPECIAL ACTIVITIES (SA).** Activities conducted in support of national foreign policy objectives, which are

planned and executed so the role of the United States Government is not apparent or acknowledged publicly. They are also functions in support of such activities, but are not intended to influence United States political processes, public opinion, policies, or media and do not include diplomatic activities or the collection and production of intelligence or related support functions.

**SPECIAL BOAT DETACHMENT (SBD).** The deployable, operational entity of a SBTP. SBDs operate combatant craft in the conduct of special operations and maintain the associated craft and equipment.

**SPECIAL BOAT TEAM (SBT).** U.S. Navy forces organized, trained, and equipped to conduct or support special operations with combatant craft and other small craft.

**SPECIAL BOAT TROOP (SBTP).** The deployable, operational entity of an SBT normally commanded by a SEAL O-3 and consists of a small C2 element, CSS and other capabilities, and one or more SBDs.

**SPECIAL FORCES (SF).** U.S. Army forces organized, trained, and equipped specifically to conduct special operations with an emphasis on unconventional warfare capabilities.

**SPECIAL FORCES GROUP (SFG).** The largest Army combat element for special operations consisting of command and control, Special Forces battalions, and a support battalion capable of long duration missions. The group can operate as a single unit, but normally the battalions plan and conduct operations from widely separated locations. The group provides general operational direction and synchronizes the activities of its subordinate battalions. Although principally structured for unconventional warfare, SFG units are capable of task organizing to meet specific requirements.

**SPECIAL OPERATIONS.** Operations requiring unique modes of employment, tactical techniques, equipment and training often conducted in hostile, denied, or politically sensitive environments and characterized by one or more of the following: time sensitive, clandestine, low visibility, conducted with and/or through indigenous forces, requiring regional expertise, and/or a high degree of risk.

**SPECIAL OPERATIONS COMMAND (SOC).** A subordinate, unified, or other joint command established by a joint force commander to plan, coordinate, conduct, and support joint special operations within the joint force commander's assigned area of operations.

**SPECIAL OPERATIONS COMMAND AND CONTROL ELEMENT (SOCCE).** A special operations element that is the focal point for the synchronization of SOF activities with conventional forces activities. It performs command and control functions according to mission requirements. It normally collocates with the command post of the supported force. It can also receive SOF operational, intelligence, and target acquisition reports directly from deployed special operations elements and provide them to the supported component headquarters. It remains under the operational control of the joint force special operations component commander or commander, joint special operations task force.

**SPECIAL OPERATIONS FORCES (SOF).** Those active and reserve component forces of the military services designated by the SecDef and specifically organized, trained, and equipped to conduct and support special operations.

**SPECIAL OPERATION JOINT TASK FORCE (SOJTF).** The special operations joint task force (SOJTF) is the principal joint SOF organization tasked to meet all special operations requirements in major operations, campaigns, or a contingency. A SOJTF is a modular, tailorable, and scalable SOF organization that allows USSOCOM to more efficiently provide integrated, fully capable, and enabled joint SOF to GCCs and subordinate JFCs based on the strategic, operational, and tactical context. Depending on circumstances, the SOJTF may be directed to serve as the joint task force (JTF), or a joint force special operations component commander (JFSOCC).

**SPECIAL OPERATIONS LIAISON ELEMENT (SOLE).** A special operations liaison team provided by the joint force special operations component commander to the joint force air component commander (if designated), or appropriate service component air command and control organization, to coordinate, deconflict, and integrate special operations air, surface, and subsurface operations with conventional air operations.

**SPECIAL OPERATIONS LOW LEVEL (SOLL).** USAF strategic and tactical airlift SOLL crews are trained to perform specialized low-level flight. SOLL II is an NVG landing, airdrop, and low-level flight capability with avionics upgrades in designated aircraft.

**SPECIAL OPERATIONS WEATHER TEAM (SOWT).** A task-organized team of Air Force personnel organized, trained, and equipped to collect critical environmental information from data-sparse areas. SOWTs are trained to operate independently in permissive or uncertain environments, or as augmentation to other special operations elements in hostile environments, in direct support of special operations.

**SPECIAL RECONNAISSANCE (SR).** Reconnaissance and surveillance actions conducted as a special operation in hostile, denied, or politically sensitive environments to collect or verify information of strategic or operational significance, employing military capabilities not normally found in conventional forces. These actions provide an additive capability for commanders and supplement other conventional reconnaissance and surveillance actions.

**SPECIAL TACTICS (ST).** U.S. Air Force special operations forces organized, trained, and equipped to conduct special operations. They include combat control team, pararescue, and special operations weather personnel who provide the interface between air and ground combat operations.

**SPECIAL TACTICS TEAM (STT).** An Air Force task-organized element of special tactics that may include combat control, pararescue, tactical air control party, and special operations weather personnel. Functions include austere airfield and assault zone reconnaissance, surveillance, establishment, and terminal control; combat search and rescue; combat casualty care and evacuation staging; terminal attack control; and environmental reconnaissance and austere weather operations.

**STRATEGIC INTELLIGENCE.** DOD Intelligence that is required for the formation of policy and military plans at national and international levels. Strategic intelligence and tactical intelligence differ primarily

in level of application but may also vary in terms of scope and detail.

**STRATEGIC PSYCHOLOGICAL ACTIVITIES.** Planned psychological activities in peace, crisis, and war, which pursue objectives to gain the support and cooperation of friendly and neutral countries and to reduce the will and capacity of hostile or potentially hostile countries to wage war.

**TACTICAL CONTROL (TACON).** Command authority over assigned or attached forces or commands, or military capability or forces made available for tasking, that is limited to the detailed direction and control of movements or maneuvers within the operational area necessary to accomplish missions or tasks assigned. Tactical control is inherent in operational control. Tactical control may be delegated to, and exercised, at any level at or below the level of combatant command. Tactical control provides sufficient authority for controlling or directing the application of force or tactical use of combat support assets within the assigned mission or task.

**TERRORISM.** The unlawful use of violence or threat of violence, often motivated by religious, political, or other ideological beliefs, to instill fear and coerce governments or societies in pursuit of goals that are usually political.

**UNCONVENTIONAL WARFARE (UW).** Activities conducted to enable a resistance movement or insurgency to coerce, disrupt, or overthrow a government or occupying power by operating through or with an underground, auxiliary, and guerrilla force in a denied area.

**U.S. COUNTRY TEAM.** The senior, in country, U.S. coordinating and supervising body, headed by the Chief of the United States diplomatic mission, usually an Ambassador, and composed of the senior member of each represented United States department or agency. (See also Country Team.)

**USSOCOM STRATEGIC PLANNING PROCESS (SPP).** A process that drives decision-making related to resourcing, acquisition, sustainment, and modernization. It is a continuous process with a biennial cycle that facilitates the shaping of the strategic direction of SOF.

**WEAPONS OF MASS DESTRUCTION (WMD).** Chemical, biological, radiological, or nuclear weapons capable of a high order of destruction or causing mass casualties and exclude the means of transporting or propelling the weapon where such means is a separable and divisible part of the weapon.

# Appendix B. Abbreviations and Acronyms

Note: These abbreviations and acronyms are included as a convenience to the reader. The official list of acronyms and their definitions can be found in Joint Pub I-02, Department of Defense Dictionary of Military and Associated Terms.

<b>ADCON.</b> Administrative Control	<b>CAPT.</b> Civil Affairs Planning Team
<b>AFRICOM.</b> Africa Command	<b>CAS.</b> Close Air Support
<b>AFSOC.</b> Air Force Special Operations Command	<b>CCDR.</b> Combatant Commander
<b>AFSOF.</b> Air Force Special Operations Forces	<b>CCT.</b> Combat Control Team
<b>AMC.</b> Air Mobility Command; Army Materiel Command	<b>CDRUSSOCOM.</b> Commander, U.S. Special Operations Command
<b>ANG.</b> Air National Guard	<b>CEP.</b> Career Education Program
<b>AO.</b> Area of Operations	<b>CFSOCC.</b> Combined Forces Special Operations Component Command
<b>AOR.</b> Area of Responsibility	<b>CFT.</b> Cross Functional Team
<b>ARNG.</b> Army National Guard	<b>CI.</b> Counterintelligence
<b>ARSOF.</b> Army Special Operations Forces	<b>CIE.</b> Cultural Intelligence Element
<b>ASCC.</b> Army Service Component Command	<b>CIM.</b> Civil Information Management
<b>ASPO.</b> ARSOF Support Operations	<b>CMO.</b> Civil-Military Operations
<b>AT.</b> Antiterrorism	<b>COCOM.</b> Combatant Command (command authority)
<b>ATV.</b> All-Terrain Vehicle	<b>COIN.</b> Counterinsurgency
<b>AZ.</b> Assault Zone	<b>COMSOCEUR.</b> Commander, Special Operations Command Europe
<b>BCT.</b> Brigade Combat Team	<b>CONOPS.</b> Concept of Operations
<b>BDE.</b> Brigade	<b>CONUS.</b> Continental United States
<b>BN.</b> Battalion	<b>CP.</b> Counterproliferation
<b>BUD/S.</b> Basic Underwater Demolition/SEAL	<b>CRO.</b> Combat Rescue Officer
<b>C2.</b> Command and Control	<b>CRRC.</b> Combat Rubber Raiding Craft
<b>C4ISR.</b> Command, Control, Communications, Computers, Intelligence, Surveillance, and Reconnaissance	<b>CS.</b> Combat Support
<b>CA.</b> Civil Affairs	<b>CSAR.</b> Combat Search and Rescue
<b>CAA.</b> Combat Aviation Advisor; Combat Aviation Advisory	<b>CSO.</b> Critical Skills Operator
<b>CAO.</b> Civil Affairs Operations	<b>CSS.</b> Combat Service Support

**CSSB.** Combat Sustainment Support Battalions

**CT.** Counterterrorism

**CTF.** Counter Threat Finance

**CUWTF.** Combined Unconventional Warfare Task Force

**CWMD.** Countering Weapons of Mass Destruction

**DA.** Direct Action

**DCS.** Direct Combat Support

**DDS.** Dry Deck Shelter

**DET.** Detachment

**DFT.** Deployments for Training

**DISA.** Defense Information Systems Agency

**DS.** Direct Support

**DZ.** Drop Zone

**E&E.** Evasion and Escape

**EA.** Enlisted Academy; Electronic Attack

**ECCM.** Electronic Counter-Countermeasures

**EEFI.** Essential Elements of Friendly Information

**EEI.** Essential Elements of Information

**EOD.** Explosive Ordnance Disposal

**EUCOM.** European Command

**EW.** Electronic Warfare

**FARP.** Forward Arming and Refueling Point

**FHP.** Force Health Protection

**FID.** Foreign Internal Defense

**FOB.** Forward Operations Base

**FOL.** Forward Operating Location

**FSC.** Forward Support Company

**FSE.** Fire Support Element

**FSF.** Foreign Security Forces

**GCC.** Geographic Combatant Command

**GMSC.** Global Mission Support Center

**GPS.** Global Positioning System

**GSB.** Group Support Battalion

**GSC.** Group Support Company

**GSSC.** Group Service Support Company

**HAHO.** High Altitude High Opening

**HALO.** High Altitude Low Opening

**HCA.** Humanitarian and Civic Assistance

**HF.** High Frequency

**HHC.** Headquarters and Headquarters Company

**HN.** Host Nation

**HNS.** Host Nation Support

**HQ.** Headquarters

**HSOC.** Home Station Operations Center

**HUMINT.** Human Intelligence

**IO.** Information Operations

**ISB.** Intermediate Staging Base

**ISR.** Intelligence, Surveillance, and Reconnaissance

**ITC.** Individual Training Course

**IW.** Irregular Warfare

**JCET.** Joint Combined Exchange Training

**JCMOTF.** Joint Civil-Military Operations Task Force

**JCS.** Joint Chiefs of Staff

**JFACC.** Joint Force Air Component Commander

**JFC.** Joint Force Commander

**JFLCC.** Joint Force Land Component Commander

**JFMCC.** Joint Force Maritime Component Commander

**JFSOCC.** Joint Force Special Operations Component Commander

**JICSOC.** Joint Information Center Special Operations Command

**JISTF (SO).** Joint Information Support Task Force (Special Operations)

**JMISC.** Joint Military Information Support Command

**JSOA.** Joint Special Operations Area

**JSOACC.** Joint Special Operations Air Component Commander

**JSOC.** Joint Special Operations Command

**JSOFSEA.** Joint Special Operations Forces Senior Enlisted Academy

**JSOTF.** Joint Special Operations Task Force

**JSOU.** Joint Special Operations University

**JTF.** Joint Task Force

**KIAS.** Knots Indicated Air Speed

**LOGSU.** Logistics Support Unit

**MARSOC.** Marine Corps Forces Special Operations Command

**MARSOF.** Marine Corps Special Operations Forces

**METL.** Mission Essential Task List

**METT-TC.** Mission, Enemy, Terrain and Weather, Troops and Support Available, Time Available, and Civil

**MFP.** Major Force Program

**MISO.** Military Information Support Operations

**MOS.** Military Occupation Specialties

**MSOB.** Marine Special Operations Battalion

**MSOC.** Marine Special Operations Company

**MSOSG.** Marine Special Operations Support Group

**MSOS.** Marine Special Operations School

**MSOT.** Marine Special Operations Team

**MTT.** Mobile Training Team

**NAS.** Naval Air Station

**NATO.** North Atlantic Treaty Organization

**NAVSO.** Navy Special Operations Forces

**NAVSPECWARCEN.** Naval Special Warfare Center

**NAVSPECWARCOM.** Naval Special Warfare Command

**NCA.** National Command Authorities

**NCO.** Noncommissioned Officer

**NEO.** Noncombatant Evacuation Operation(s)

**NP.** Nonproliferation

**NSW.** Naval Special Warfare

**NSWG.** Naval Special Warfare Group

**NSWTG.** Naval Special Warfare Task Group

**NSWTU.** Naval Special Warfare Task Unit

**NVG.** Night-Vision Goggles

**OAD-A.** Operational Aviation Detachment Alpha

**OCONUS.** Outside the Continental United States

**OPCON.** Operational Control

**OPSEC.** Operations Security

**PACOM.** Pacific Command

**PE.** Preparation of the Environment

**PJ.** Pararescue

**PME.** Professional Military Education

**PR.** Personnel Recovery

**PRC.** Populace and Resources Control

**PSYOP.** Psychological Operations

**RAAWS.** Ranger Anti-Armor Weapons System

**RC.** Reserve Component

**RDT&E.** Research, Development, Test and Evaluation

**RIB.** Rigid-hull Inflatable Boat

**ROK.** Republic of Korea

**RSOD.** Ranger Support Operations Detachment

**RSTB.** Regimental Special Troops Battalion

**SA.** Special Activities

**SACEUR.** Supreme Allied Commander Europe

**SAO.** Security Assistance Organizations

**SATCOM.** Satellite Communications

**SBT.** Special Boat Team

**SBTP.** Special Boat Troop

**SBTP-C.** Special Boat Troop - Coastal

**SBTP-R.** Special Boat Troop - Riverine

**SCA.** Support to Civil Administrations

**SCUBA.** Self-Contained Underwater Breathing Apparatus

**SDO/DATT.** Senior Defense Official/Defense Attaché

**SDV.** SEAL Delivery Vehicle

**SDVT.** SEAL Delivery Vehicle Team

**SEAL.** Sea-Air-Land

**SEALTP.** Sea-Air-Land Troop

**SERE.** Survival, Evasion, Resistance, Escape

**SecDef.** Secretary of Defense

**SF.** Special Forces

**SFA.** Security Force Assistance

**SFG.** Special Forces Group

**SFG(A).** Special Forces Group (Airborne)

**SFOD.** Special Forces Operational Detachment

**SIMO.** Systems Integration and Maintenance Office

**SJA.** Staff Judge Advocate

**SOA.** Special Operations Area; Special Operations Aviation

**SOAR.** Special Operations Aviation Regiment

**SOATC.** Special Operations Aviation Training Company

**SOC.** Special Operations Command; Special Operations Capable

**SOCAFRICA.** Special Operations Command, Africa

**SOCCE.** Special Operations Command and Control Element

**SOCCENT.** Special Operations Command, Central

**SOCEUR.** Special Operations Command, Europe

**SOCKOR.** Special Operations Command, Korea

**SOCNORTH.** Special Operations Command, North

**SOCOM.** Special Operations Command

**SOC PAC.** Special Operations Command, Pacific

**SOC SOUTH.** Special Operations Command, South

**SOF.** Special Operations Forces

**SOF AT&L.** Special Operations Forces Acquisition, Technology, and Logistics

**SOG.** Special Operations Group (USAF)

**SOJTF.** Special Operations Joint Task Force

**SOLE.** Special Operations Liaison Element

**SOLL.** Special Operations Low Level

**SOS.** Special Operations Squadron

**SOTF.** Special Operations Task Force

**SOW.** Special Operations Wing

**SOWT.** Special Operations Weather Team

**SPECRECON Team (NSW).** Special Reconnaissance Team

**SR.** Special Reconnaissance

**STT.** Special Tactics Team

**SWCC.** Special Warfare Combatant-craft Crewmen

**TACON.** Tactical Control

**TDA.** Table of Distribution and Allowance

**TF.** Task Force

**TF/TA.** Terrain Following/Terrain Avoidance

**TOE.** Table of Organization and Equipment

**TRADET.** Training Detachment

**TSC.** Theater Security Cooperation

**TSOC.** Theater Special Operations Command

**TTP.** Tactics, Techniques, and Procedures

**UA.** Unmanned Aircraft

**UAS.** Unmanned Aircraft Systems

**UHF.** Ultra-High Frequency

**UMT.** Unit Maintenance Team

**USAF.** U.S. Air Force

**USAFRICOM.** U.S. Africa Command

**USAID.** U.S. Agency for International Development

**USAJFKSWCS.** U.S. Army John F. Kennedy Special Warfare Center and School

**USASFC.** U.S. Army Special Forces Command

**USASOAC.** U.S. Army Special Operations Aviation Command

**USASOC.** U.S. Army Special Operations Command

**USCENTCOM.** U.S. Central Command

**USEUCOM.** U.S. European Command

**USFK.** U.S. Forces Korea

**USG.** U.S. Government

**USMC.** U.S. Marine Corps

**USNORTHCOM.** U.S. Northern Command

**USPACOM.** U.S. Pacific Command

**USSOCOM.** U.S. Special Operations Command

**USSOUTHCOM.** U.S. Southern Command

**UW.** Unconventional Warfare

**VEO.** Violent Extremist Organization

**VHF.** Very High Frequency

**WMD.** Weapons of Mass Destruction

**WO.** Warrant Officer





# Appendix C. Bibliography

Joint Pub 1-02, *Department of Defense Dictionary of Military and Associated Terms*, 8 November 2010, amended through 15 January 2015

Joint Pub 3-0, *Joint Operations*, 11 August 2011

Joint Pub 3-05, *Doctrine for Joint Special Operations*, 16 July 2014

Joint Pub 3-13, *Information Operations*, 27 November 2012

Joint Pub 3-13.2, *Military Information Support Operations*, 21 November 2014

Joint Pub 3-22, *Foreign Internal Defense*, 12 July 2010

Joint Pub 3-24, *Counterinsurgency Operations*, 22 November 2013

Joint Pub 3-26, *Counterterrorism*, 24 October 2014

Joint Pub 3-28, *Defense Support of Civil Authorities*, 31 July 2013

Joint Pub 3-50, *Personnel Recovery*, 20 December 2011

Joint Pub 3-57, *Civil-Military Operations*, 11 September 2013

Joint Pub 5-0, *Joint Operation Planning*, 11 August 2011

USSOCOM Publication 1, August 2011

USSOCOM Strategic Capabilities Guidance, May 2013

USSOCOM *2020 Strategy*, May 2013

USSOCOM *SOF Operating Concept*, May 2013

USSOCOM *Fact Book*, 2015



